

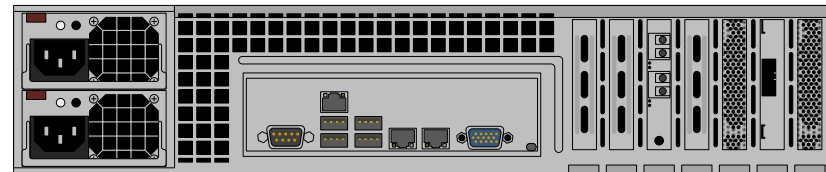

SM Server (Air 2)

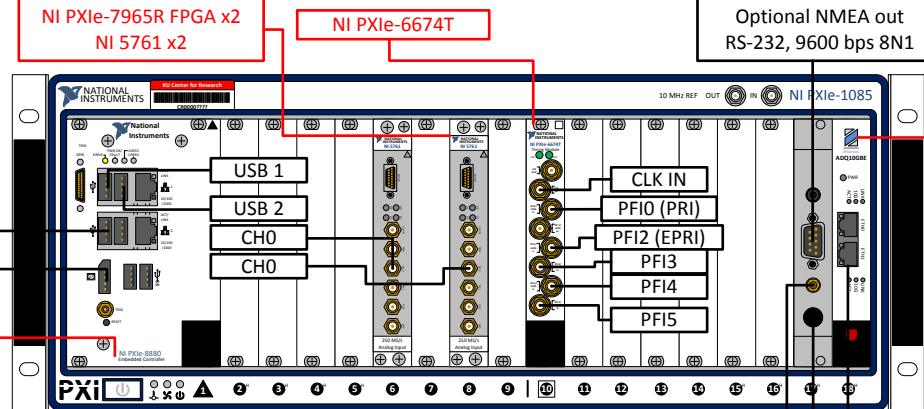

Universal AC Input. Please refer to NI PXIe-1085 Series User Manual



NI PXIe-1085

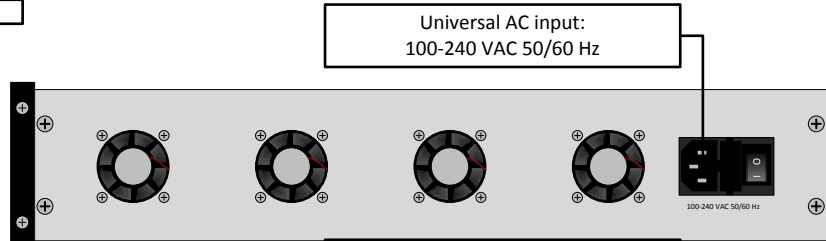
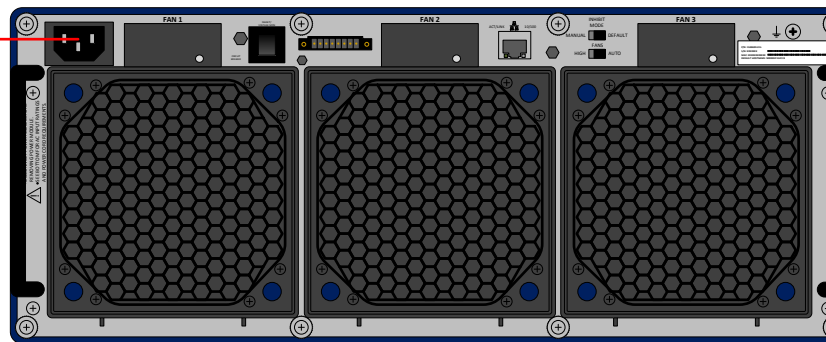
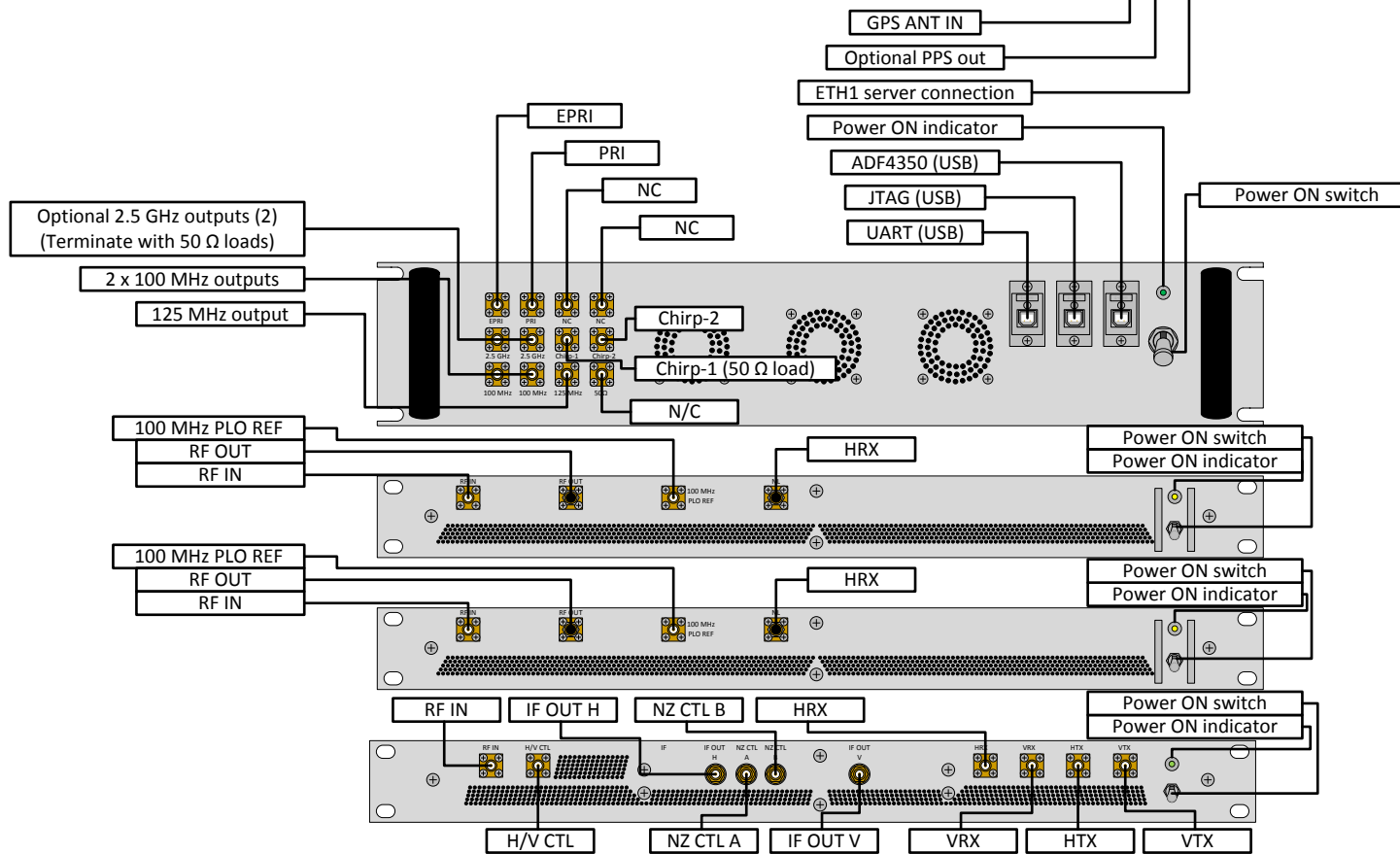

DDS

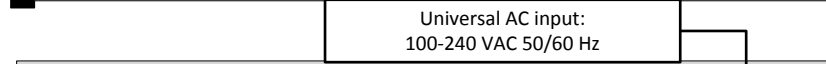

W.G. #1



W.G. #2

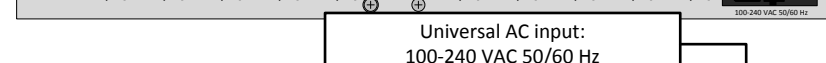

Tx/Rx



APC UPS

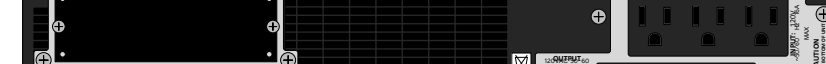
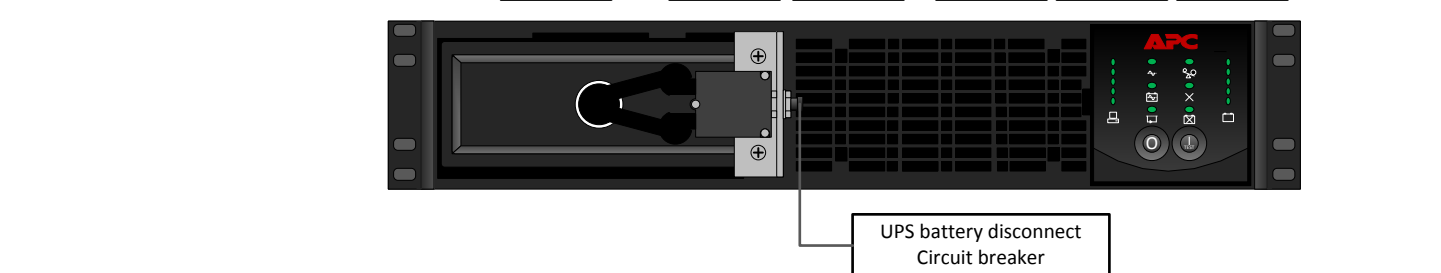

CRISIS – University of Kansas
 2335 Irving Hill Rd.
 Lawrence, KS 66045
 (785) 864-4390
 Http://www.crisis.ku.edu/

Project Title: Snow Radar Connection Diagram
 Engineer: J. Evers
 Revised: F. Rodriguez-Morales
 Date: _____ Version: V 1.1
 Notes: Refer to Snow_front_panel_cabling.xlsx for cable definition
 9/3/15: 50 Ohm load next to 125 MHz clock is not needed. Leave port open.