

Quick Start Guide for Multibeam Kongsberg EM 712 on RV “Heincke”

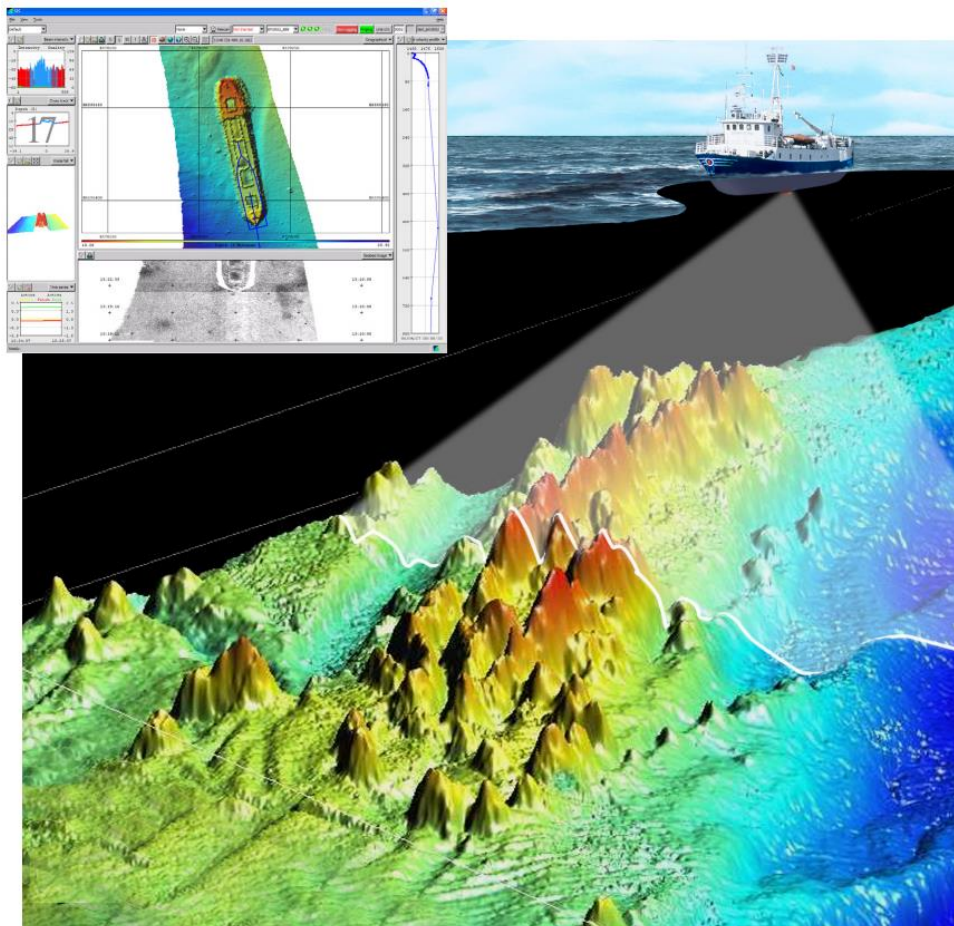

Source: Kongsberg SIS Operator Manual

Contact:

FIELAX Gesellschaft für wissenschaftliche Datenverarbeitung mbH

Schleusenstr. 14, D-27568 Bremerhaven, GERMANY

Fon: +49 (0)471 30015-0, Fax: +49 (0)471 30015-22

Mail: echo-support@fielax.de

Ref.: RV-Heincke_Multibeam-Support.pdf	Vers.: 1.9	Date: 11.02.2022	Status: final
--	------------	------------------	---------------



Contents

1	Introduction	4
2	Hardware configuration	4
2.1	Sensor equipment.....	4
2.2	Sensor structure	4
2.3	Sensor layout / alignment	5
3	SIS – Kongsbergs Acquisition Software	8
3.1	Start SIS (SIS Operator Manual - page 94).....	8
3.2	Start a new survey	9
3.3	Using background data.....	11
3.4	Check runtime parameters.....	11
3.5	Start the echo sounder	12
3.6	Start and stop pinging.....	13
3.7	Start and stop logging.....	13
3.8	Plan a new job	14
3.9	Run the survey	14
3.10	Interferences and External Triggering.....	15
3.11	Remote Control / Watch using VNC.....	16
4	Sound velocity measurements	16
4.1	Operate Valeport MIDAS SVP	16
4.2	SVP editor	18
5	Post Processing in CARIS HIPS.....	22
5.1	Create a new project.....	23
5.2	Convert raw data	24
5.3	Save session	24
5.4	Clean auxiliary sensor data.....	25
5.5	Sound velocity correction (Optional)	25
5.6	Load Tide	25
5.7	Merge	25
5.8	Process swath data	25
5.9	Define new field sheets.....	26
5.10	Generate BASE surface.....	26
5.11	Export data	26
6	Tips and tricks	27
6.1	Planning survey lines in SIS	27
6.2	Line spacing	28
7	Appendix.....	30



7.1 Latest Service and Calibration Report HE589 (02.-04.02.2022).....30

History

Version / Date	Description
1.0 / 03.03.2010	First version
1.1 / 15.02.2013	Chapter 2.3 Sensor layout / alignment: Update of location offsets
1.2 / 15.04.2013	Added Chapter 3.11, External Triggering
1.3 / 05.02.2014	Added Chapter 3.3, background data
1.4 / 26.11.2014	Added Chapter 3.10, INS heave calculation
1.5 / 02.09.2016	GPS sensor naming & EM710 calibration parameters
1.6 / 17.02.2017	Updated position for GPS sensor "Trimble"; new calibration report (7.1); new chapter 3.12 on how to use VNC
1.7 / 05.03.2019	New calibration report
1.8 / 02.03.2020	New calibration report
1.9 / 10.02.2022	Updated report due to new EM & SIS version



1 Introduction

This manual intends to give the scientific user of the multibeam echosounder system on board RV “Heincke” a brief overview including the configuration, operation and a quick step-through for data processing in CARIS HIPS.

2 Hardware configuration

2.1 Sensor equipment

The following sensors are installed on the FS “Heincke”:

Table 1: Sensor specifications

Sensor	Model	Details from Manufacturer
Inertial Navigation System (INS)	IXSEA PHINS III	Heading accuracy: 0.05 deg (without aiding) Roll, Pitch accuracy: 0.01 deg Heave accuracy: 5 cm or 5%
Primary Positioning Sensor	Trimble SP461	Primary Positioning system DGPS 0.5 – 3 m accuracy
Backup Positioning Sensor	SAAB R5	Backup Positioning system DGPS GPS: 3m, DGPS: 1m (2D RMS)
Thermosalinograph (TSG)	Seabird SBE21+SBE38	Provides calculated sound velocity
Sound Velocity Transducer Probe (SVT)	Valeport miniSVS	Range: 1375 – 1900 m/s Resolution: 0.001 m/s, Accuracy: ± 0.02 m/s
Sound Velocity Profiling Probe (SVP)	Valeport MIDAS	Range: 1375 – 1900 m/s Resolution: 0.001 m/s, Accuracy: ± 0.02 m/s

2.2 Sensor structure

Figure 1 shows the sensor structure of the multibeam echosounder hardware. The processing unit is the main unit which controls the transmitter, gets the sounding data from the receiver, and receives position information from the Trimble DGPS receiver as well as attitude data (heading, roll, pitch, heave, velocity-z) from Ixsea PHINS III inertial navigation system (INS). Sound velocity at transducer level is provided by the thermosalinograph (TSG) via DSHIP. A backup sensor is a sound velocity transducer (SVT) probe. For measuring vertical sound velocity profiles in the water column you may use the shipboard CTD or the sound velocity profiling probe (SVP).

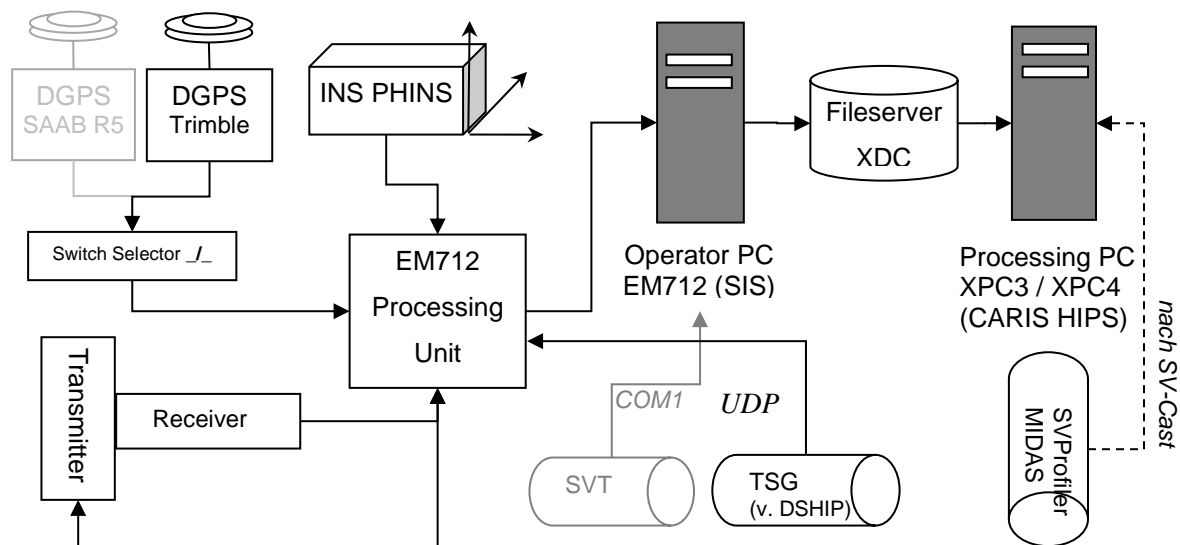

Figure 1: Sensor dependencies

2.3 Sensor layout / alignment

The sensor layout and alignment has been measured by the surveying company Overath & Sand Ship Surveyors. The Inertial Navigation System (INS) is located in the coordinate origin. All offsets of the transmitting transducer (TX), the receiving transducer (RX) and the GPS-Antennas refer to the INS position:

Position system 1	Trimble			Serial port 1	GGA	ACTIVE-OK
Name:	Trimble					
	Forward, X	Starboard, Y	Downward, Z			
Location offset (XYZ)	- 13.649 +	- 2.976 +	- -11.406 +			

Figure 2: Location offsets GPS Antenna

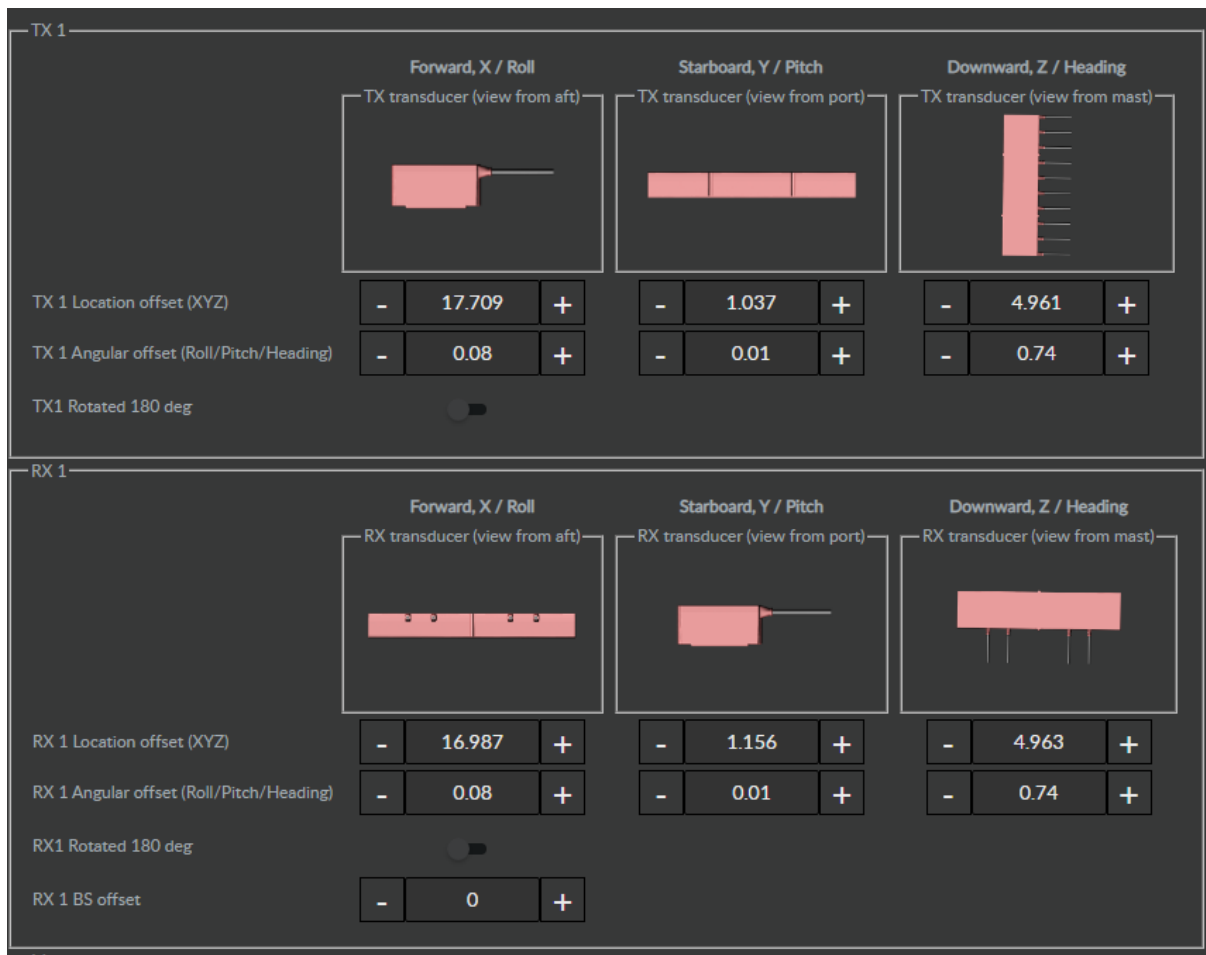

Figure 3: Location offsets Transducer TX & RX

The angular misalignment of the transducer and transmitters with respect to the INS:



-	Attitude system 2	Attitude system name	Net port 1	KM Binary
Name:	Attitude system name			
	Forward, X / Roll	Starboard, Y / Pitch	Downward, Z / Heading	
Location offset (XYZ)	- 0 +	- 0 +	- 0 +	
Angular offset (RPH)	- 0.07 +	- -0.01 +	- 0 +	
Attitude delay (s)	- 0 +			
Roll reference plane	Rotation			
Format	KM Binary			
Input	Net port 1			
Ethernet adapter:	Second net			
Port:	- 27000 +			

Figure 4: Angular offsets

Sensor setup x

EM712_71

+	System Name	Device Name	Serial port	Protocol	Status
+	Position system 1	Trimble	Serial port 1	GGA	ACTIVE-OK
+	Position system 2	Position system name	No	GGA	OFF
+	Position system 3	Position system name	No	GGA	OFF
+	Attitude system 1	Attitude system name	No	EM Attitude	OFF
+	Attitude system 2	Attitude system name	Net port 1	KM Binary	ACTIVE-OK
+	Depth/pressure	Depth system name			OFF
+	Sound velocity probe	Valeport Mini SVS	From HWS	AML SVT	MISSING
+	Time system	Clock name	Serial port 1	ZDA	OK OK

Set active systems

Active position system: Position system 1

Active attitude system: Attitude system 2

Figure 5: Sensor Setup Settings



3 SIS – Kongsbergs Acquisition Software

Figure 6 shows the normal sequence of operations required for survey runs using SIS.

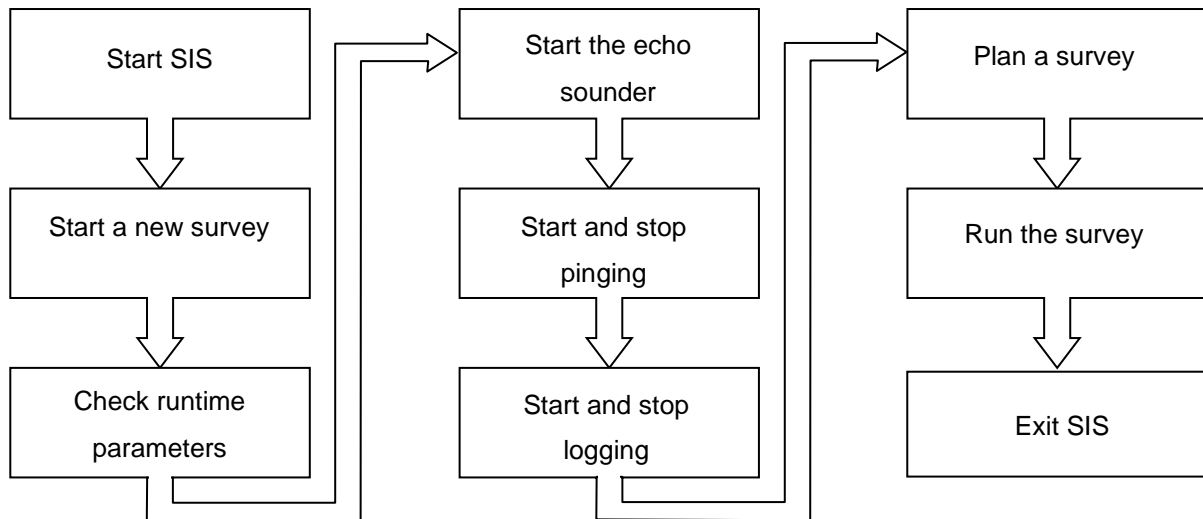

Figure 6: Workflow diagram for survey runs with SIS

3.1 Start SIS (SIS Operator Manual - page 94)

- Power up the echo sounder units (*by captain*)
- Power up the SIS Operator Station





(username and password please ask the captain)

- The operating system on the SIS Operator Station loads automatically. When the boot process is finished, the SIS program can be opened
- Click on the SIS icon on the desktop or select SIS from the Windows start menu

3.2 Start a new survey

(Referring SIS Operator Manual - page 95)

To create a new survey project at the beginning of a new expedition open the **New survey** frame (Figure 7).

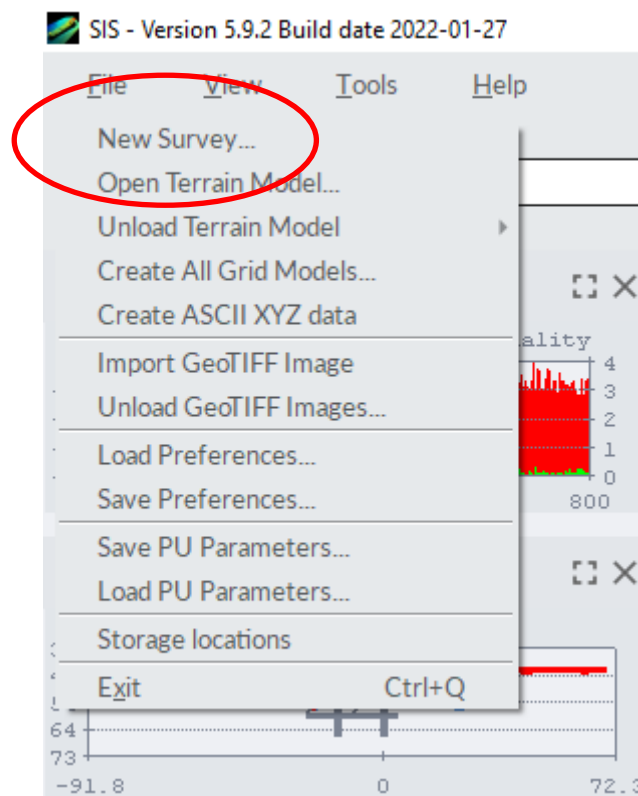

Figure 7: Open the New Survey Window

Important **New Survey** parameters to set are:

- **New survey name:** Enter a unique new survey name descriptive to the survey (Figure 8).

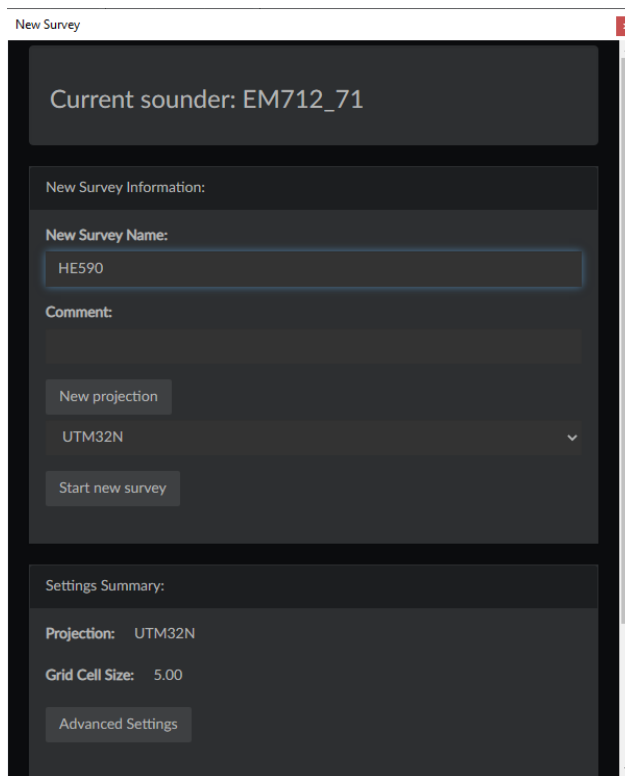

Figure 8: Basic parameters display

- **New projection:** Select map projection. It should be either **UTM31N_WGS84** or **UTM32N_WGS84** depending on the working area (Figure 9).

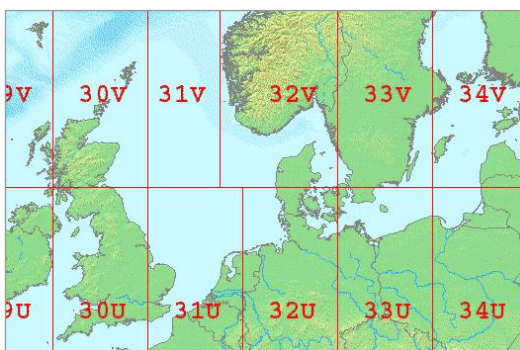

Figure 9: UTM cells in the North Sea

When finished, press **OK**.



3.3 Using background data

To display background data such as coastlines, the data needs to be imported into the SIS geographical view.

- First open the import/export window. (**File -> Import GeoTIFF Image...**)
- Select Image and press **Ok** again to finish importing the background data. The image is now displayed in the SIS **geographical view**.

To remove background data from SIS go back into the **Unload GeoTiff Images window** select the item you wish to remove from Background Images.

A background image file containing the European coastlines can be found on the SIS-Operator PC.

3.4 Check runtime parameters

(Referring SIS Operator Manual - page 103)

The runtime parameters are associated with the echo sounder and not with the survey (Figure 10).

Important Runtime parameters to set are:

- **Maximum angle:** Select **Sounder Main**. Under **Sector Coverage/ Max. Angle** the maximum swath width can be defined by setting the maximum port and starboard angles. The maximum angle possible is 70°. Recommend is an angle between 45° and 55° depending on the sea state.
- **Depth settings:** Select **Sounder Main**. Make sure that the **Minimum Depth** and **Maximum Depth** settings are appropriate limits for the survey area or at least for the current location where the survey is planned to start. If the real depth is beyond these limits, the echosounder will not find the seafloor!
- **Ping Mode:** Select **Sounder Main**. Under **Depth settings/Ping Mode** the operational mode of the EM712_71 is defined. The Ping Mode should be set to **AUTO**.
- **Select SVP profile:** Select **Sound Speed**. The sound speed profile parameter allows to select the sound speed profile to be used in the echo sounder's depth calculations (See also Chapter 4.2).

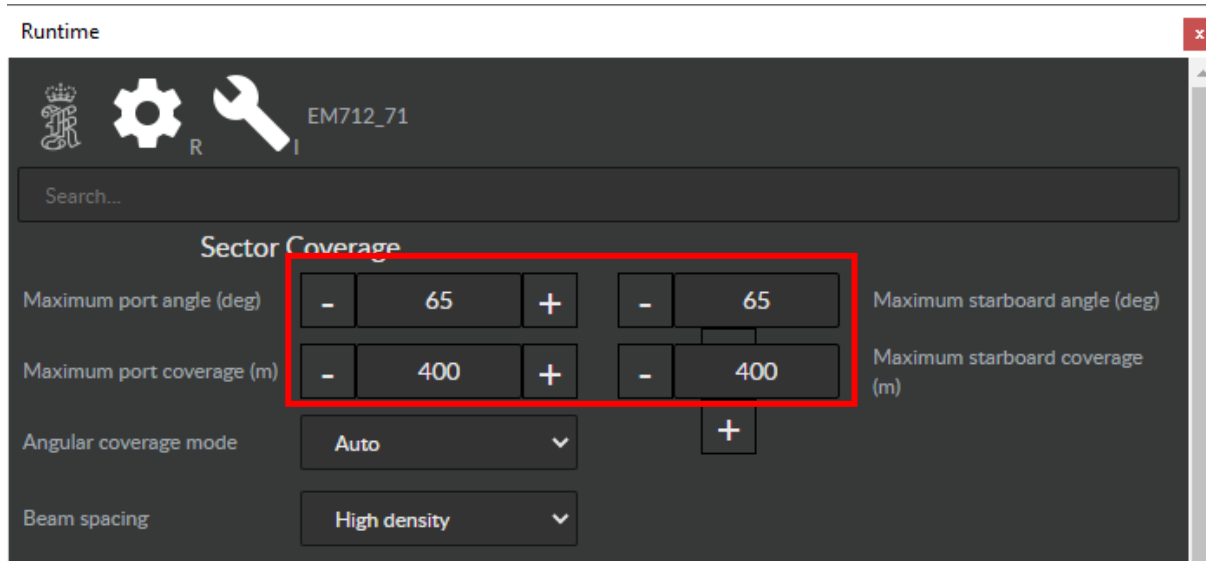

Figure 10: Runtime parameters display

3.5 Start the echo sounder

(Referring SIS Operator Manual - page 126)

Before starting pinging, the echo sounder must be turned on. Select the echo sounder from the **Echo sounder - not started** combo box (Figure 11). The **Logging** and **Pinging** buttons will all be disabled until the echo sounder is ready. When the echo sounder is ready, pinging can be started.

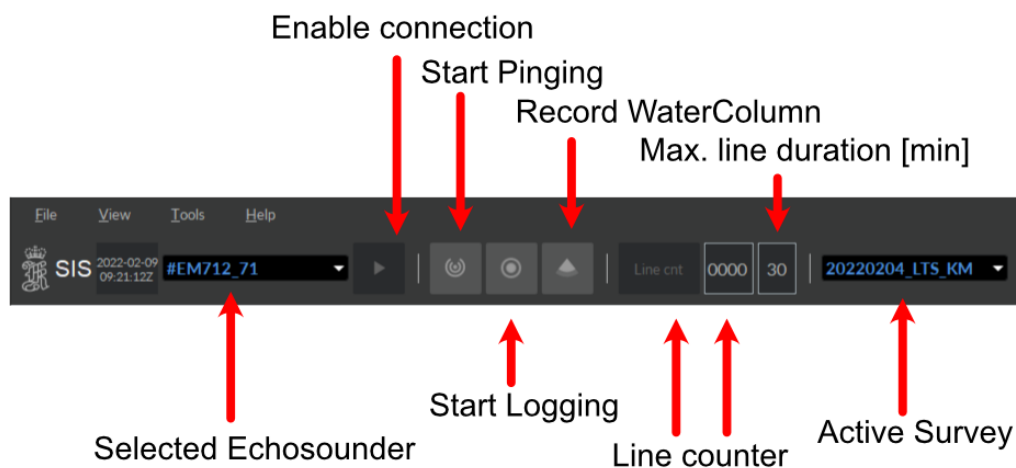

Figure 11: The main frame



3.6 Start and stop pinging

(Referring SIS Operator Manual - page 46)

Pinging must be started manually after the echo sounder is ready. Press the **Pinging** button on the toolbar. The button is red when **Off** and green when **On** (Figure 11).

3.7 Start and stop logging

(Referring SIS Operator Manual - page 46 and following)

Logging must be started manually after the echo sounder is ready. When the echo sounder has started logging, data is automatically saved to disk in *.kml file format (Figure 11).

Note that if pinging is **Off** when logging is turned **On**, pinging will automatically be turned **On**.

If logging is **On** and pinging is turned **Off**, logging will automatically be turned **Off**.

For logging the water column data press the **WCL** button on the toolbar it will turn from grey to red if logging is enabled and will turn green during logging (Figure 11). This data will be written to *.wcd files in your selected folder, separately from the *.all files.

Warning: Water column data will be much larger than the default multibeam data (1 to 2 GB per hour extra). Please make sure to move these files regularly from the acquisition PC.



3.8 Plan a new job

The planning module allows creating survey lines in the area to be surveyed. With this tool survey lines can be created which the vessel must sail. Please refer to the SIS Operator Manual - page 20.

3.9 Run the survey

On board of RV "Heincke" the raw multibeam data will be stored under ***E:\sisdata\raw\...*kmal***.

Load Job:

- Open the **Planning module** frame
- Expand **Jobs**
- Press the **Open job** button
- Select the file where the planned survey lines are stored
- Expand **Remote**
- Press **Transfer plan** so send the planned lines and objects to the remote helmsman display

During the survey:

- Observe the **Geographical window** which gives an overall control of the performance of SIS and the multibeam echo sounder.
- Observe logging, pinging and line number status on the right hand side of the toolbar.
- Observe the **Numerical display**, where the sensor data values can be monitored.
- Observe the three status lamps on the main toolbar which give status of hardware units (applies to multibeam echo sounders only) (Figure 11).
- Observe the **Cross track** display. The **cross track** window shows the measured depths in all beams from the last ping. If it forms a smiley or a frown the sound velocity profile is not suitable anymore and as a result wrong depths are calculated.



3.10 Interferences and External Triggering

Echosounders may interfere with other hydroacoustic systems such as other echosounders, ADCPs, Doppler velocity log of the vessel, etc. and also with general ship's noise like engines, propellers or sea water pumps. Especially echosounders operating at the same or the multiple of the EM712 transmission/reception frequencies (70 to 100 kHz) are potential interferers. If you receive a lot of erroneous data from the EM712 especially in the inner beam section and in continuous intervals you should consider switching off other instruments. On RV Heincke the following instruments could or do interfere with the EM712:

- Navigation sounder (Navlot) at 50 kHz
- Scientific fishery echosounder EK80 at 38, 70, 120 and/or 200kHz
- ADCP 150 kHz and ADCP 600 kHz
- Underwater Positioning System GAPS at 22 to 30 kHz
- Sediment echosounder SES2000 at 100 kHz and 5-15 kHz

To avoid sounding interferences with the Sub Bottom Profiler SES2000 it is possible to synchronize the pinging between SES2000 and EM712 by use of an external trigger (Figure 12). The external trigger signal is configured in the SES2000 software (compare FIELAX Manual RV Heincke_SubBottomProfiler_Support.pdf, Chapter 3 Synchronisation with Multibeam Echosounder EM712). **Caution:** If this checkbox is checked without running SES2000 and its activated trigger, no pinging with EM712 will be possible!

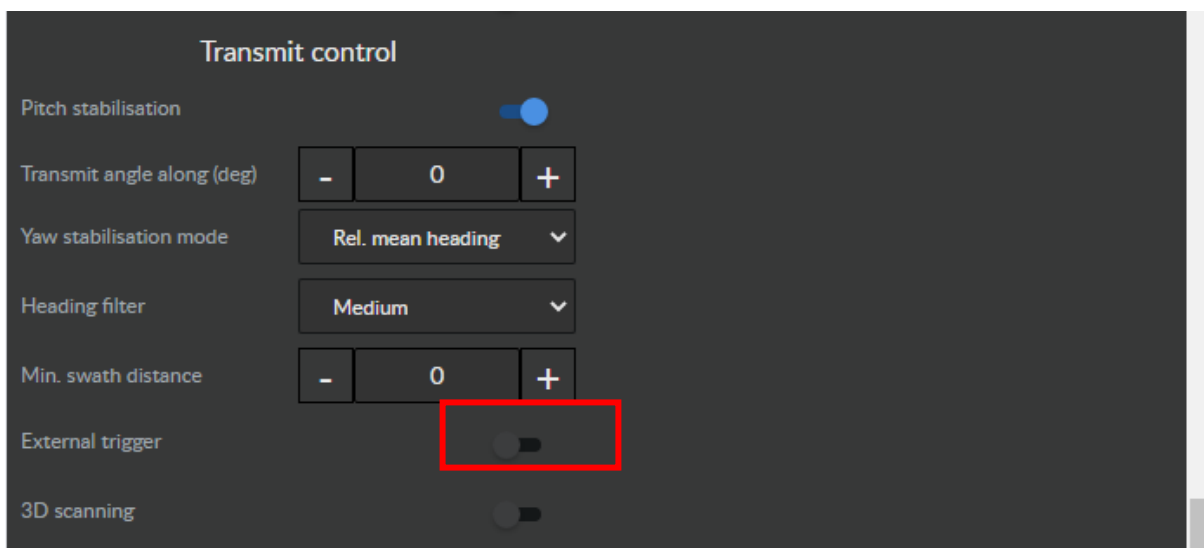
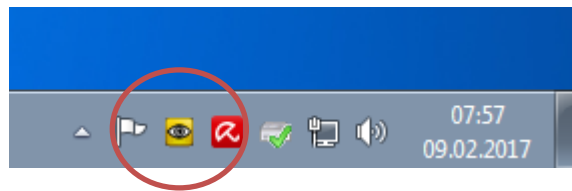

Figure 12 - External Trigger enabling/disabling in SIS



3.11 Remote Control / Watch using VNC

To remote control or watch the EM712 operator PC the software VNC is installed on the operator PC as a service. The operator PC's host name is EM712, ip address is 192.168.150.55. The password can be set in the settings menu of VNC (right click on icon below, Admin Settings):



Using VNC client software you may connect to this PC. It is installed on the EK60-PC at the bridge officer's starboard panel and at the XPC3 in dry lab.

4 Sound velocity measurements

On board of RV "Heincke" sound velocity profiles can be measured using the Valeport MIDAS SVP probe, which is stored in the dry lab.

We strongly recommend measuring a sound velocity profile before starting a new survey. Depending on the survey area, duration and purpose this should be repeated regularly.



4.1 Operate Valeport MIDAS SVP

The Valeport program **Data Log Express** is installed on the computer **xpc3** in the dry lab (**username: mbesadmin, password: please ask the captain**).

Preparation of the probe in the lab:

- Connect the SV probe with the computer (xpc3) on the serial COM port



- Start **Data Log Express**
- Connect to the probe
- Check the settings
- Select **OFFLINE** acquisition mode
- Start the acquisition with **RUN**
- Remove the serial cable and put on the dummy plug

!!!! With the dummy plug on the probe is online and uses up the batteries !!!!

Measurement in the water:

- Lower the SV probe to the desired depth
- Heave it back on deck
- Rinse the probe with clear water and dry the probe

Data export:

- Dry the connectors and remove the dummy plug
- Connect the serial cable again to the computer's serial COM port
- Start **Data Log Express**
- **Upload** the data file (*.000) to the computer. This is a plain text ASCII file that contains the measured sound velocity values over depth. This file can be imported to the SVP Editor in SIS (see next chapter)
- Disconnect the SV Probe from the PC and secure safely in the case. **DO NOT PUT ON THE DUMMY PLUG.**

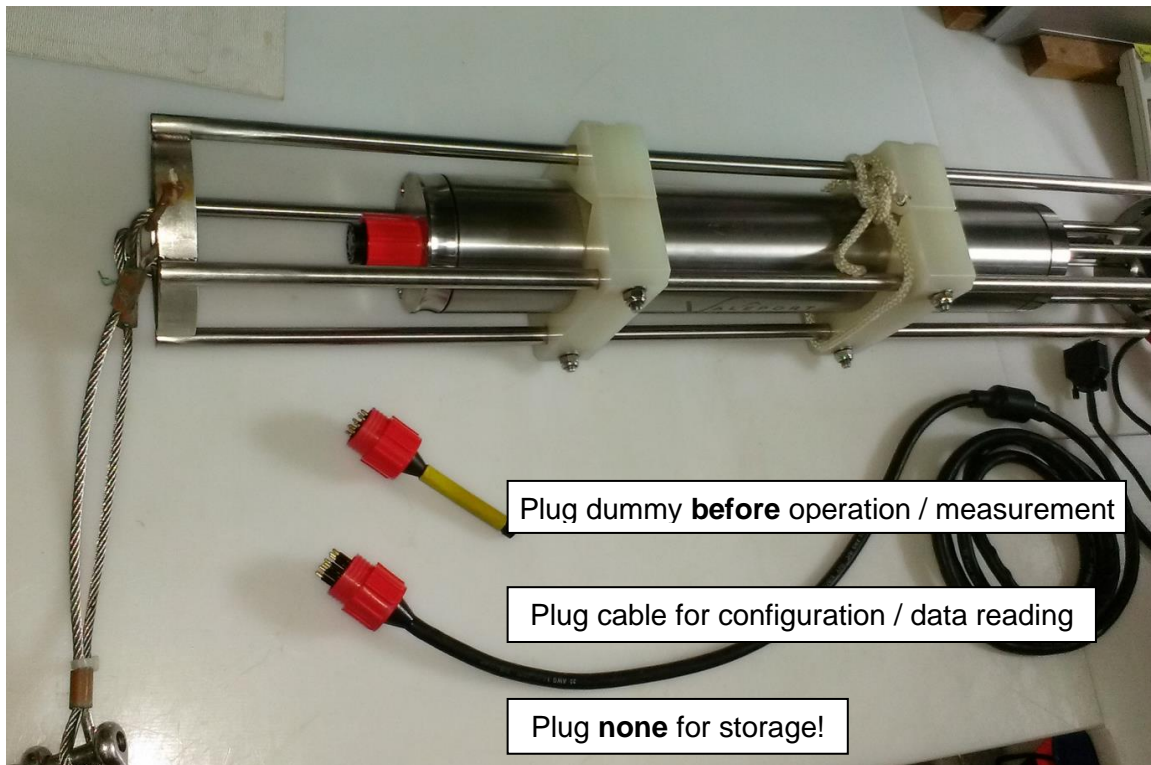

4.2 SVP editor

(Referring SIS Operator Manual - page 43)

By using the SVP editor any column based ASCII format file can be converted to the ***.asvp** format read by SIS.

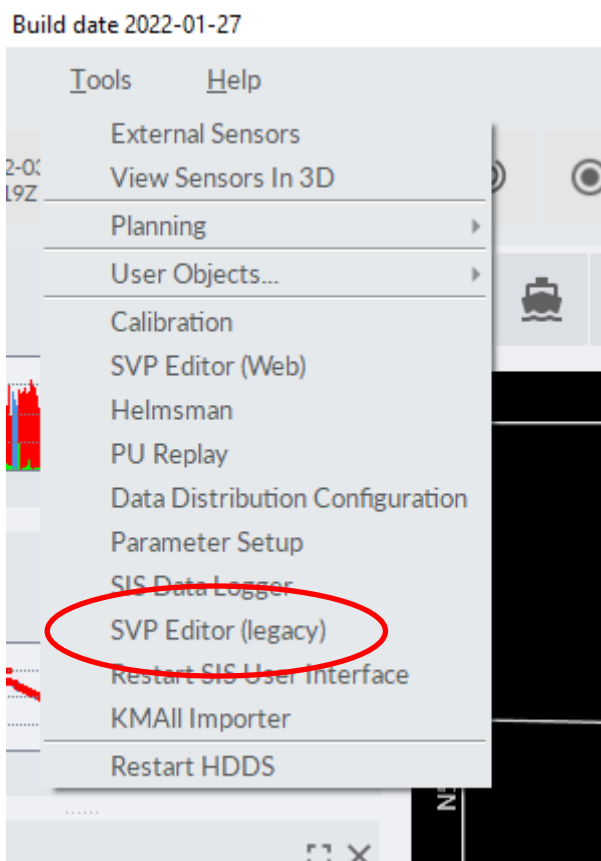

Figure 13 - Import SVP

Open the SVP file (**File/Open in editor**):

- Browse for the SVP input file and press **Open**. The **Raw file editor** opens
- Select the delimiter from the drop down list. Choose "<tab>". (Figure 14)

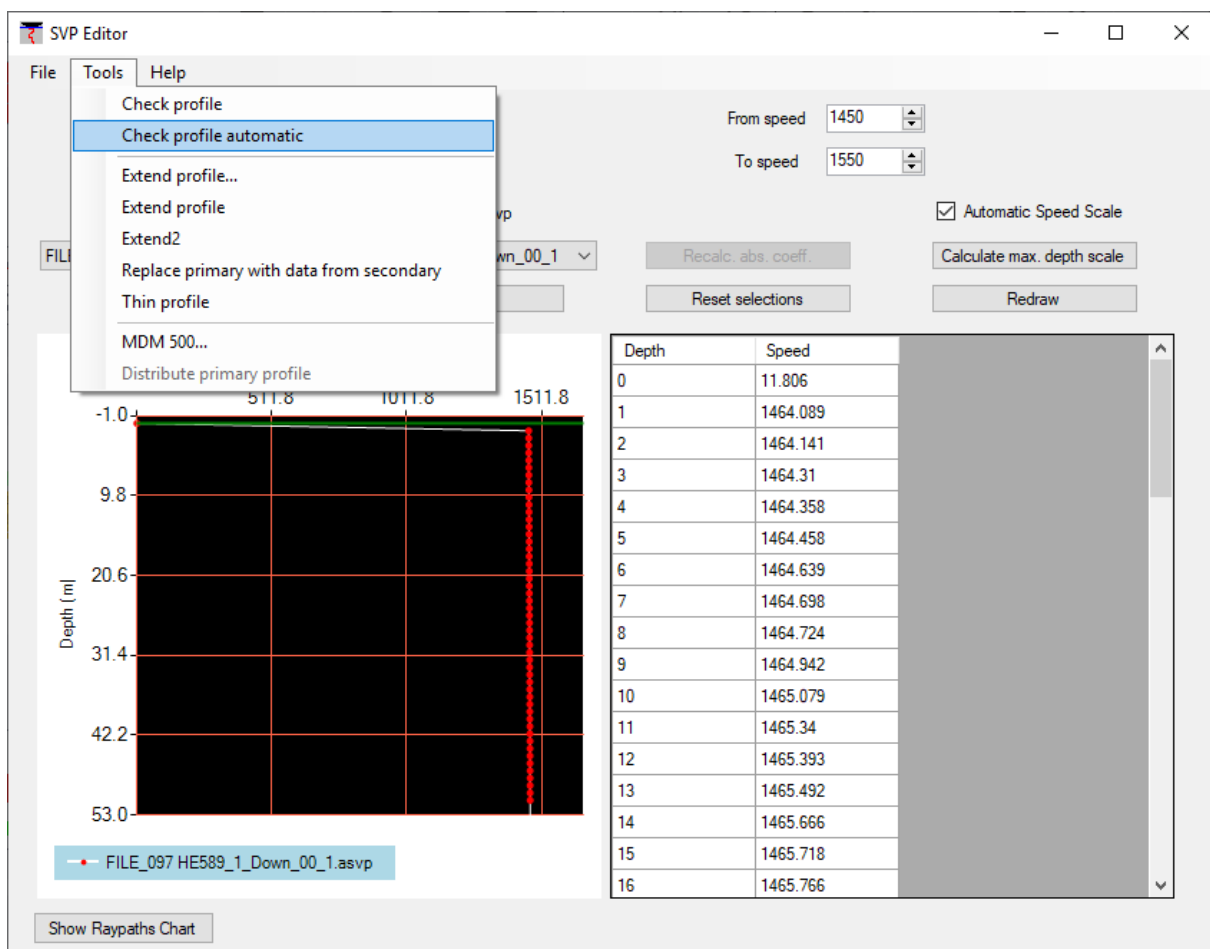

Figure 14: Check profile

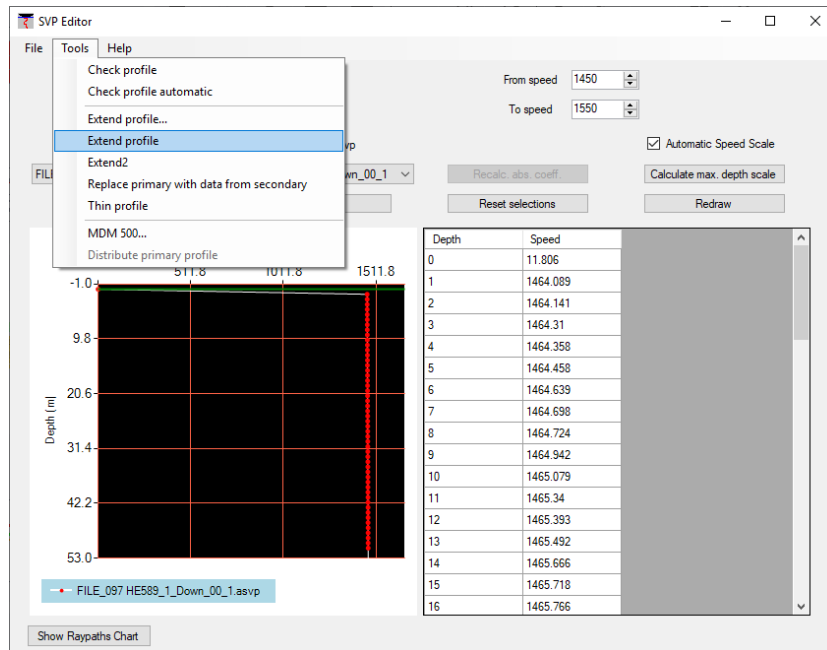

Figure 15: Extend profile

- Press “Extend profile” in the Menu to extend the SVP to 12000 m depth, which is necessary for SIS.

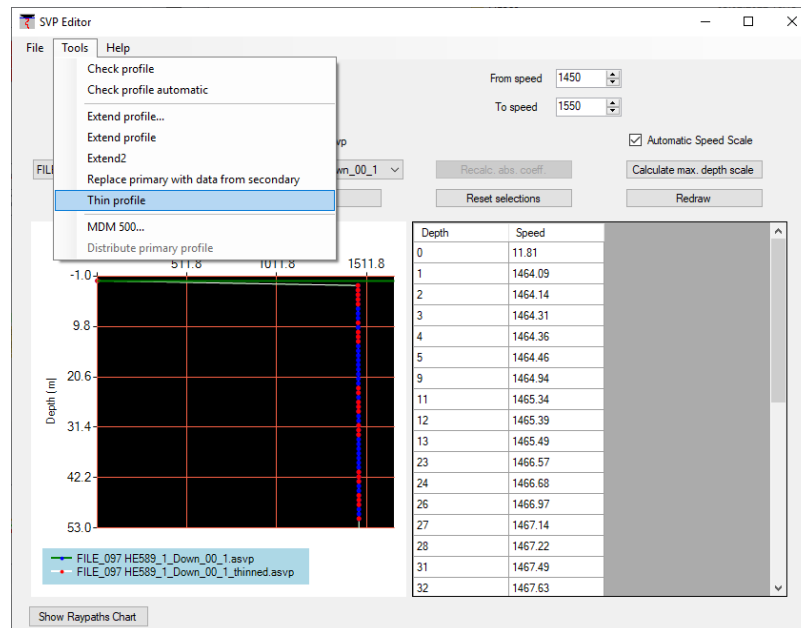

Figure 16: Thin profile



- A window opens for a thinning factor. Chosse 0.1 and press OK. The thin profile results will be displayed. The SVP will then be automatically directed and saved by SIS.

Select **Runtime parameters/Sound speed**:

- Use the browse button to open the correct *.asvp file
- Press **Use Sound Speed Profile** to apply the selected sound speed profile

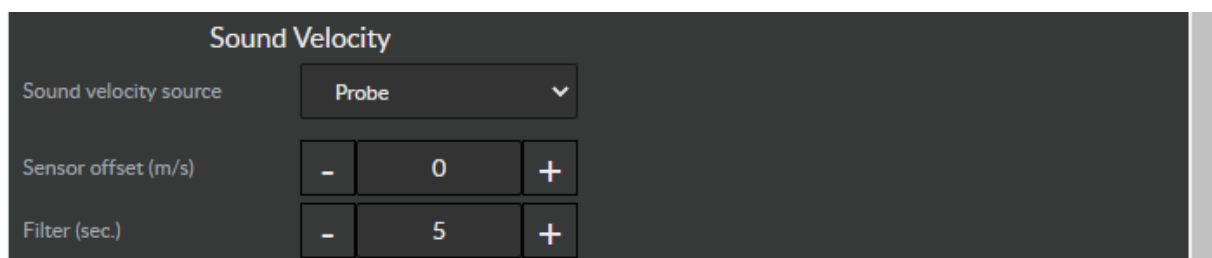

Figure 17: Select sound speed profile

5 Post Processing in CARIS HIPS

The processing software Caris HIPS is installed on the computers **xpc3** and **xpc4** (**username: mbesadmin**). For the **dongle** and the **password** please ask the captain.

To import the kmall files to HIPS you have to convert the files with the build in Conversion Tool from Kongsberg. The Shurtcut of the application is placed on the desktop.

Before processing the data copy the raw data from the SIS Operator station to the Data Processing Station via the Netstorage Server **xdc**. Figure 18 shows the most important steps for cleaning multibeam data. Also refer to **HIPS and SIPS v81 - Quick Reference for Multibeam data** and **HIPS and SIPS User´s Guide**.

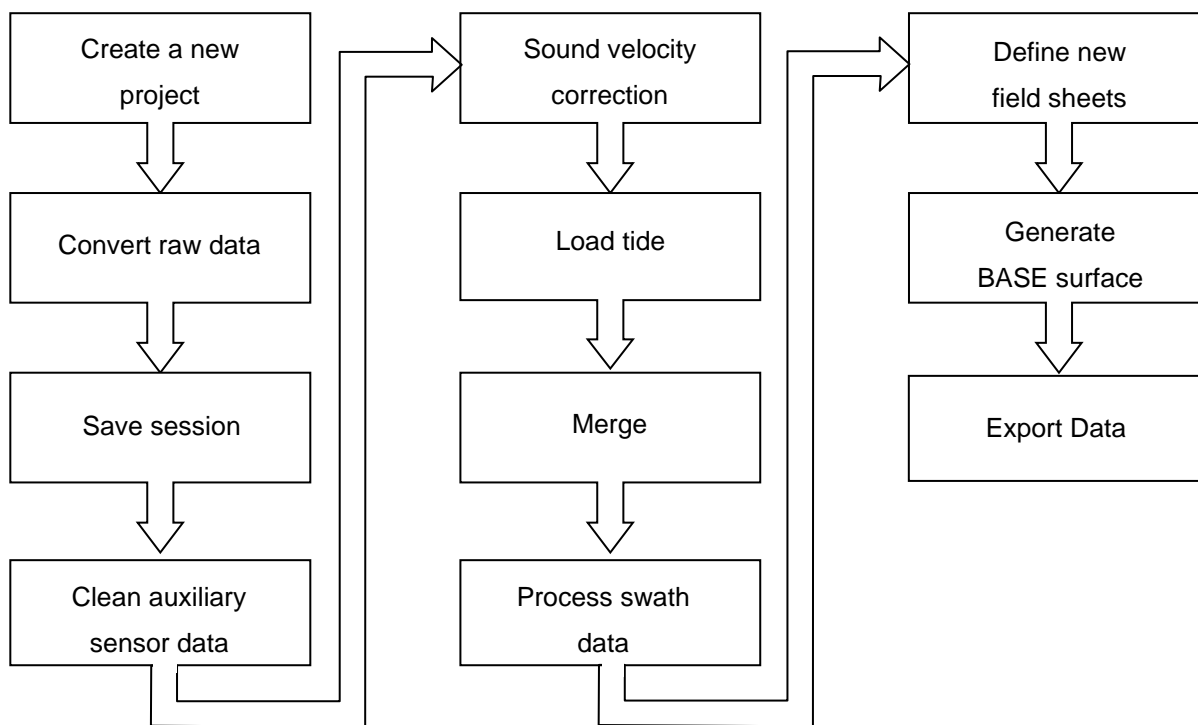

Figure 18: Workflow diagram for processing multibeam data

5.1 Create a new project

(Referring HIPS & SIPS User's Guide - page 125)

To create a new project-Vessel-Day directory tree structure to store data go to **File/Project/New** and enter a new project name, the vessel and the first day of the survey in Julian Day (number of day in a year, 001-365).



5.2 Convert raw data

(Referring HIPS & SIPS User's Guide - page 170)



Copy the raw-data of SIS (*E:\sisdata\raw\...*.all*) to the CARIS-PC. HIPS and SIPS files are created from survey data using the Conversion Wizard. To start the conversion process, activate the HIPS **Conversion Wizard**.

1. Select the survey data format "**Simrad**" - Click **Next**
2. Pick the files to be converted - Click **Next**
3. Select the Project/Vessel/Day or raw data files and click **Open** - Click **Next**
4. Select the coordinate system (UTM 32N for German Bay) - Click **Next**
5. Enter range of extents. Automatically set to maximum range - Click **Next**
6. Start conversion by clicking **Next** (Figure 19)

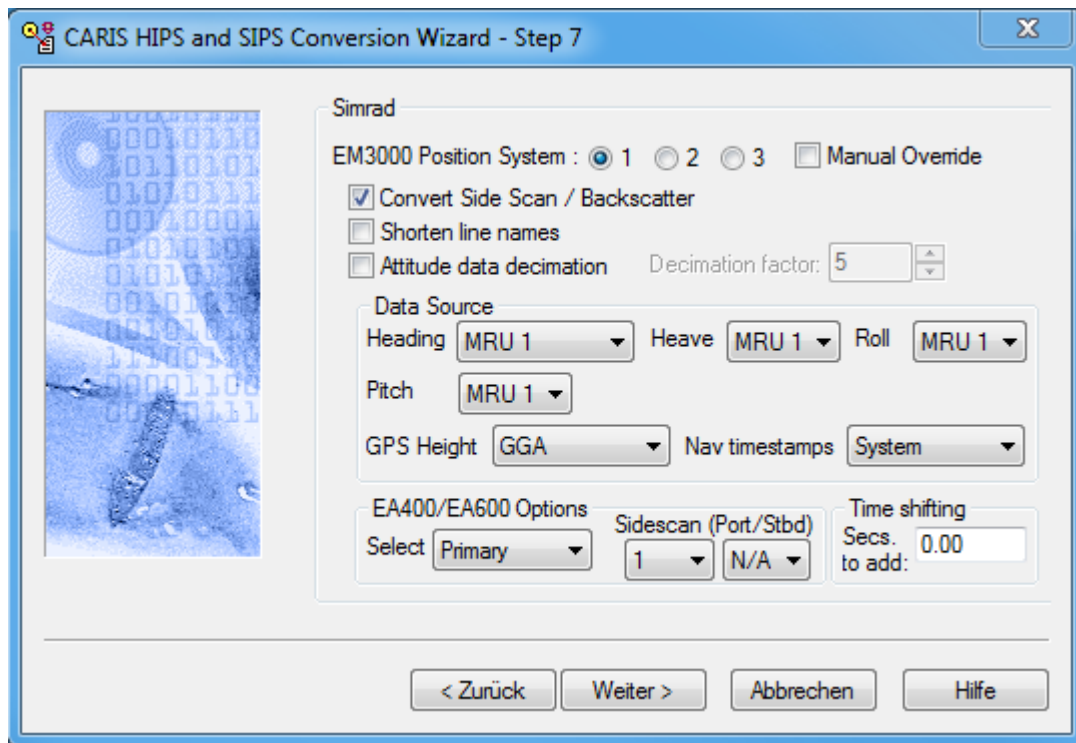

Figure 19: Step 7 of the Conversion Wizard

5.3 Save session

(Referring HIPS & SIPS User's Guide - page 159)

Save the currently open data as a session file (**File/Save Session As**).



5.4 Clean auxiliary sensor data

(Referring HIPS & SIPS User's Guide - page 261)



Open the **Navigation Editor** to view and clean the vessel's navigation data. Take a look at the navigation for each survey line to make sure, that no error in the GPS will affect the measured data. When detecting GPS errors mark them with the left mouse button and press either



Reject-With Interpolation or



Reject-Break Interpolation to remove outlier data.

When finished, save and close the navigation editor.

5.5 Sound velocity correction (Optional)



Only relevant if not already applied in SIS. Select the survey lines the sound velocity data shall be applied to and click **Sound Velocity Correction**. Select the respective *.asvp file and press **OK**.

5.6 Load Tide

(Referring HIPS & SIPS User's Guide - page 215)



Select the survey lines and press **Load Tide**. Select the respective *.tid file and press **OK**. Take the zero.tid file if you don't have a tide file.

NOTE: The tide file should have the following format:

Date (YYYY/DD/MM) Time (00:00:00) Tide (0.00) >> (2010/09/02 02:50:00 1.50)

5.7 Merge

(Referring HIPS & SIPS User's Guide - page 253)



To create a position/depth value for each sounding select a line or group of lines and press **Merge**. Lines must have tide loaded before they can be merged.

5.8 Process swath data

(Referring HIPS & SIPS User's Guide - page 299)



Open the **swath editor** to examine and clean soundings recorded by the multibeam system. With this tool it is possible to reject wrong bottom detection beams. It is possible to flag false beams and accept beams.

5.9 Define new field sheets

(Referring HIPS & SIPS User's Guide - page 349)



To define a new field sheet select **New Field Sheet**.

1. Type a name for the field sheet in the **Name** text box – Click **Next**
2. Select a map projection (**UTM-WGS84**) and zone for the field sheet - Click **Next**
3. Press the cross line button and define the field sheet extents by using the mouse to create a rectangle defining the extents– Press **Finish**

5.10 Generate BASE surface

(Referring HIPS & SIPS User's Guide - page 408)

To create a BASE surface (bathymetric grid), click on the field sheet – right mouse click – create BASE surface. Enter the desired resolution and foot print in pixel. Common settings are 2 m single resolution, surface type swath angle and a foot print of 9 pixels.

5.11 Export data

(Referring HIPS & SIPS User's Guide - page 585)

To export data go to **File/Export** (Figure 20). All possible export options are listed. For external use only, the exports *HIPS to ASCII*, *BASE Surface To ASCII* and *BASE Surface To Image* are recommended. Please note that an export can last several hours, in particular HIPS to ASCII, depending on data size.



Figure 20: CARIS HIPS and SIPS Export options

6 Tips and tricks

6.1 Planning survey lines in SIS

A survey is normally planned taking the following into account:

- Echo sounder coverage
- Seafloor topography
- Sound speed variations
- Weather conditions

Please note, that all drawing and selecting commands are performed by pressing CTRL & left mouse button. To end all kind of drawings, the changes must be confirmed by clicking CTRL & right mouse button and accept.

To create a new job click **New Job**, enter a descriptive name of the job and select the preferred coordinate format. Then a new line or polygon can be created – depending on the survey plan - by activating the corresponding button (**New Line/New Polygon**). The respective mode is active until another option is selected or the button is pressed once more. Create a new line or polygon by holding the CTRL key while clicking the left mouse button for each new point of the line or for each node in the polygon respectively. At the end click CTRL and the right mouse button to accept the operation. Lines/Polygons can be edited using **Edit selected**. Note that the object has to be selected first. Now it is possible to insert for example the exact coordinates of the line/polygon.



Fill Polygon

A polygon can be filled with lines with specific line spacing. Therefore a new line just outside but near the polygon has to be created. The length of the line should be related to the maximum extent of the polygon in this orientation. For filling the polygon select both the polygon and the line and press **Fill Polygon**. Now the distance and spacing between the parallel lines can be defined (both port and starboard directions). How to determine the line spacing is explained in the following chapter. Every line has a defined direction, marked with a square at the start of the line. To reflect the sailing, select every second line and press **Reverse Line**. When finished save the job (**Save Job**). The coordinates of the start- and endpoints of the new survey lines will be saved as a ASCII file under E:\sisdata\common\planning.

6.2 Line spacing

To determine the line spacing the achievable coverage of the multibeam echo sounder and the overlap required between neighbouring lines is required. The echo sounder coverage depends on the opening angle (α) of the multibeam and the water depth (h) (Figure 21).

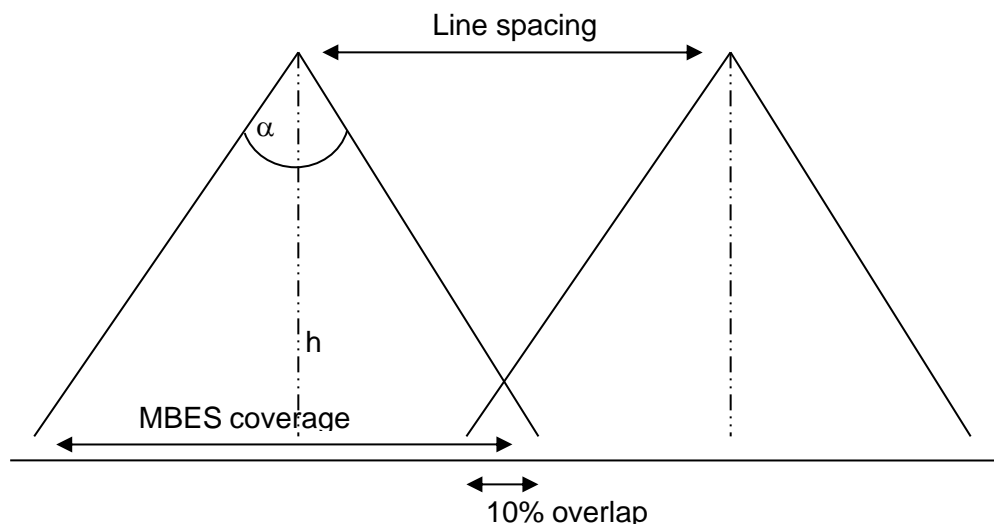

Figure 21: Important parameters for determining the line spacing

For a full coverage survey, including 10 % overlap, the line spacing can be calculated as follows:



$$\begin{aligned}\alpha &= 55^\circ \\ h &= 30 \text{ m} \\ \text{MBES coverage} &= \tan(55) \cdot 30 \cdot 2 = 85.7 \text{ m} \\ \text{Overlap (10\%)} &= 0.1 \cdot (\tan(55) \cdot 30) = 4.3 \text{ m} \\ \text{Line spacing:} &= \text{MBES coverage} - \text{Overlap} = 85.7 \text{ m} - 4.3 \text{ m} = 81.4 \text{ m}\end{aligned}$$

The vessel speed depends on the desired resolution and on the weather condition while acquiring the data. Typically a speed of 6 knots is appropriate.



7 Appendix

7.1 Latest Service and Calibration Report HE589 (02.-04.02.2022)

German only!

7.1.1 Übersicht

Die Reise HE589 der FS „Heincke“ wurde unter anderem als Erprobungsfahrt für durch Fa. FIELAX betreute Systeme genutzt. Die durchgeführten Arbeiten und Ergebnisse werden in diesem Bericht zusammengefasst.

Teilnehmer: FIELAX – Nehring, Heckel, Tardeck, AWI – Krocker, Kongsberg – Olaf Lautenschläger, Briese – Frank Börner

Zeitraum: 02.- 04.02.2022

Ziel: Nordsee, Region Helgoland

Wetter: Diesig, ~5-7 °C, Wind (W-NW) 5-6 Bft abflauend, Seegang anfangs 2-3m abflauend auf ca. 1.5 m am 03.02.2022

7.1.2 Fächerlot Kongsberg EM712

Generelle Arbeiten:

- ✓ Testbetrieb und Datenaufzeichnung mit SIS
- ✓ Datenauswertung und –begutachtung mit SIS
- ✓ Aufräumen des Operator-PCs
- ✓ Aktualisierung des FIELAX Startup Manuals auf v1.9

Fächerlot-Kalibrierung

Am 02.02. wurde für die Datenaufzeichnung der Kalibrierprofile ein aktuelles Wasserschallprofil resultierend aus den zuvor durchgeführten Messungen mit einer SVP Valeport Midas verwendet. Um ausreichend Daten für eine gute Berechnung der Kalibrieroffsets für Pitch, Roll und Heading zu erhalten wurden insgesamt 11 Profile gemessen. Die Offsets für Roll, Pitch und Heading wurden neu bestimmt. Der Kongsbergtechniker empfahl die Werte für TX und RX gleichzusetzen, was umgesetzt wurde. Roll: 0.04°, Pitch -0,21° und Yaw: 0,54°. Für Roll wurde eine Korrektur von 0.04°, für Pitch wurde eine Korrektur von -0,2°, und für Heading eine Korrektur von +0,2° berechnet und im SIS Programm angebracht. Die neuen Winkel wurden gleichermaßen den Transducern (RX/TX) angebracht. Roll beträgt nun 0,08°, Pitch 0,01° und Yaw 0,74°. Die Attitude-Werte wurden unverändert übernommen.



Nur die Latency wurde auf Null gesetzt, da eine Verzögerung durch die PPS Technik auszuschließen ist.

Ergebnis der Kalibrierung

Parameter	Vorjahr 2022	Aktuell
Position Latency	-500 ms	0 ms
Roll	0,07°	0,07°
Pitch	-0,1 °	-0,1°
Heading	0,00°	0,00°

RX	Roll	Pitch	Yaw
2021	0.04	0.28	0.54
2022	0.08	0.01	0.74

TX	Roll	Pitch	Yaw
2021	-0.02	0.21	0
2022	0.08	0.01	0.74

Abbildung 1: Ergebnisse der Fächerlot-Kalibrierung 2022

Hintergrundkarte für SIS

Zur groben Orientierung gibt es für SIS eine Hintergrundkarte. Diese deckt die wesentlichen Fahrtgebiete von FS Heincke ab und enthält eine grobe Bathymetrie (Quelle BSH und GEBCO 2014) sowie Küstenlinien. Die Karte liegt als georeferenziertes TIFF in der Projektion UTM 32N in den Auflösungen 600 und 1200 dpi vor. Sie kann in SIS per „Load Background Data“ aus dem Ordner „d:\rawdata\common\background“ importiert werden.



Abbildung 2: Hintergrundkarte für SIS zur Orientierung



Kalibrierprofilplanung:

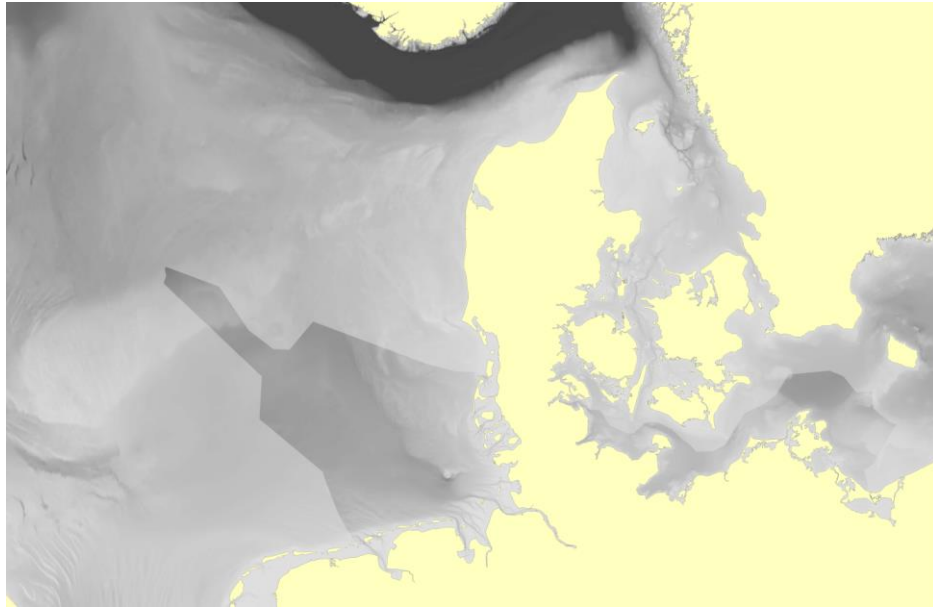
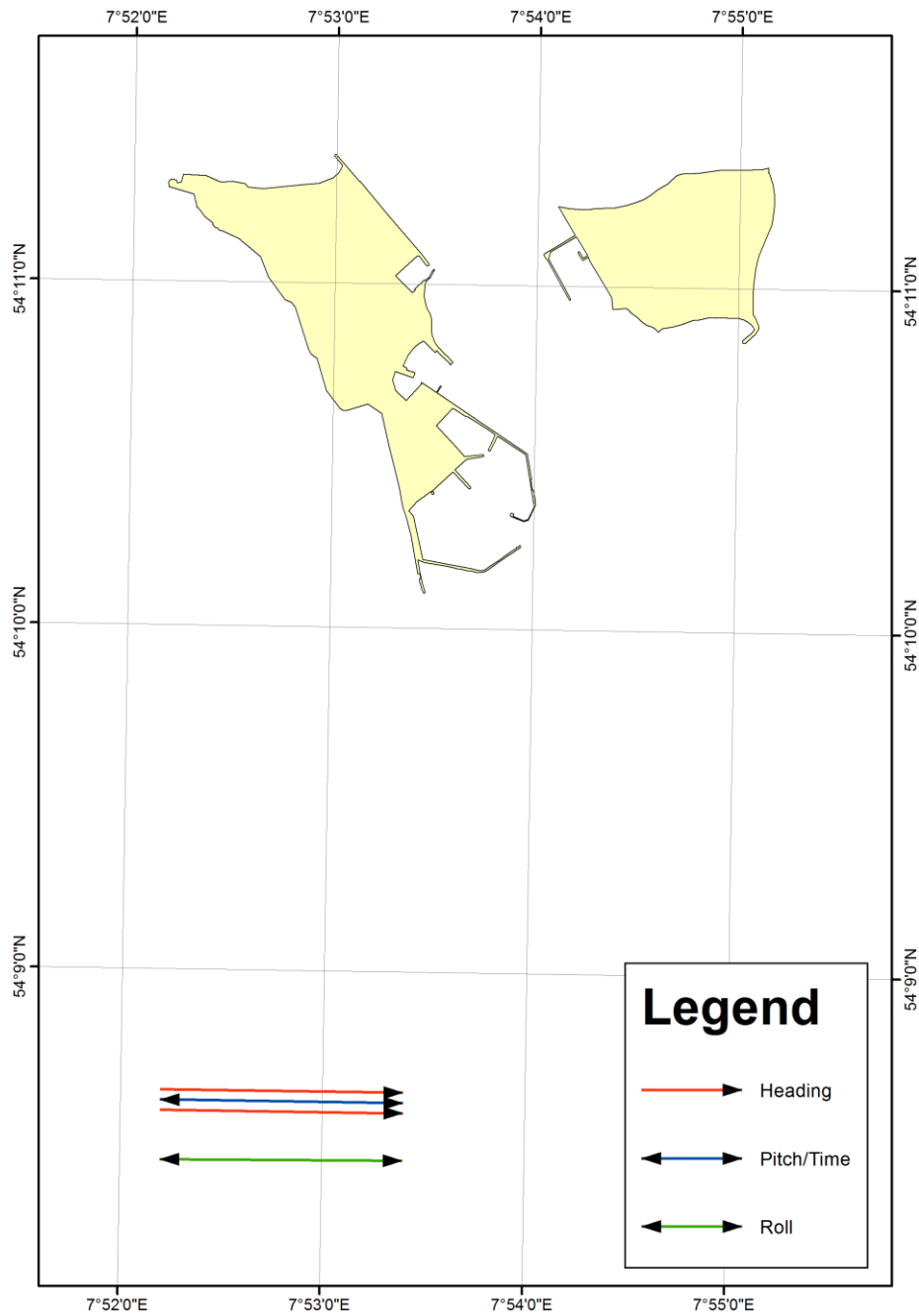

Abbildung 3: Übersichtskarte der Kalibrierungsprofile für das EM712 südlich von Helgoland



Profilliste:

Datum	Uhrzeit	Latitude / Longitude Start		Latitude / Longitude Ende		Speed [kn]
02.02.2022						
Roll 1	13:14 – 13:21	54.140767 / 7.870000	54°8.446' N / 7°52.2' E	54.140883 / 7.890000	54°8.453' N / 7°53.4' E	6,0
Roll 2	13:28 – 13:36	54.140883 / 7.890000	54° 8.453' N / 7°53.4' E	54.140767 / 7.870000N	54°8.446' N / 7°52.2' E	6,0
Pitch 1	13:39 – 13:46	54.143667 / 7.869967	54°8.620' N / 7°52.198' E	54.143667 / 7.890000	54°8.620' N / 7°53.400' E	6,0
Pitch 2	13:53 – 14:00	54.143667 / 7.890000	54°8.620' N / 7°53.400' E	54.143667 / 7.869967	54°8.620' N / 7°52.198' E	6,0
Heading 1	14:06 – 14:13	54.143167 / 7.869967	54°8.590' N / 7°52.198' E	54.143167 / 7.890000	54°8.590' N / 7°53.400' E	6,0
Heading 2	14:36 – 14:43	54.144167 / 7.869967	54°8.650' N / 7°52.198' E	54.144167 / 7.890000	54°8.650' N / 7°53.400' E	6,0