

Quick Start Guide for Multibeam Kongsberg EM 710 on RV “Heincke”

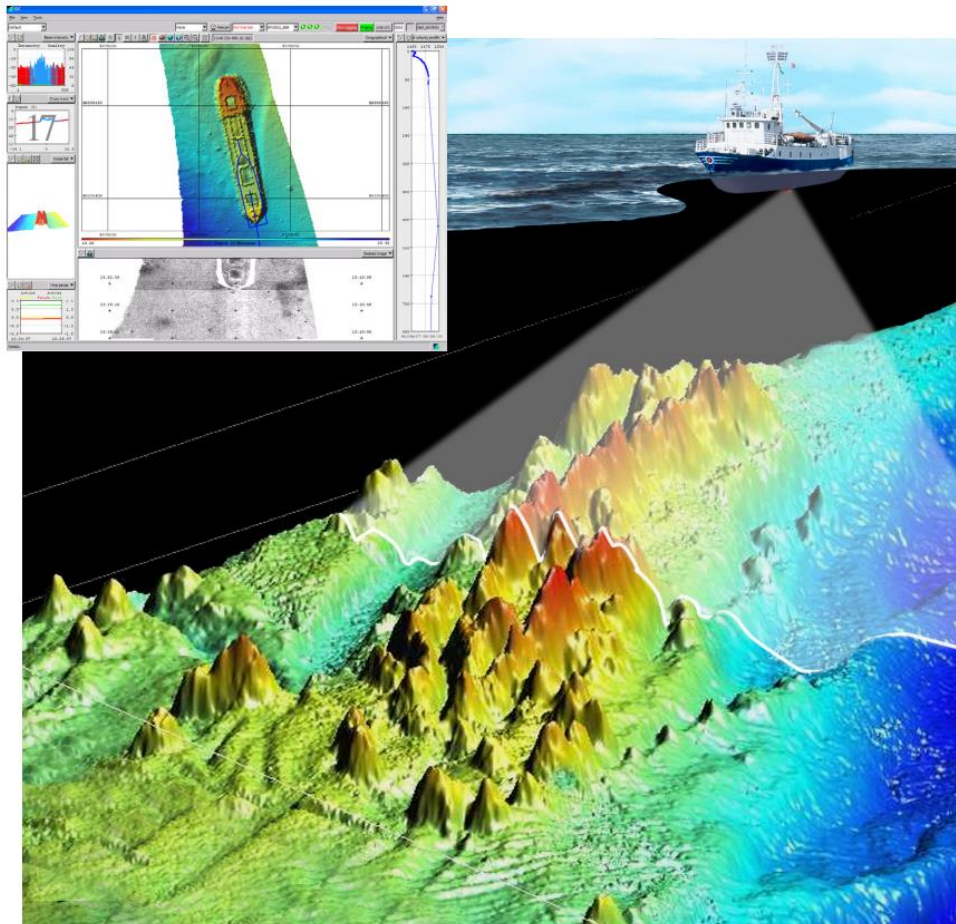

Source: Kongsberg SIS Operator Manual

Contact:

FIELAX Gesellschaft für wissenschaftliche Datenverarbeitung mbH

Schleusenstr. 14, D-27568 Bremerhaven, GERMANY

Fon: +49 (0)471 30015-0, Fax: +49 (0)471 30015-22

Mail: echo-support@fielax.de

Ref.: RV-Heincke_Multibeam-Support.pdf	Vers.: 1.8	Date: 02.03.2020	Status: final
--	------------	------------------	---------------



Contents

1	Introduction	4
2	Hardware configuration	4
2.1	Sensor equipment.....	4
2.2	Sensor structure	4
2.3	Sensor layout / alignment	5
3	SIS – Kongsbergs Acquisition Software	7
3.1	Start SIS (SIS Operator Manual - page 94).....	7
3.2	Start a new survey	7
3.3	Using background data.....	10
3.4	Check runtime parameters.....	11
3.5	Start the echo sounder	12
3.6	Start and stop pinging.....	13
3.7	Start and stop logging.....	13
3.8	Plan a new job	14
3.9	Run the survey	15
3.10	Change INS parameters for heave calculation.....	16
3.11	Interferences and External Triggering	17
3.12	Remote Control / Watch using VNC.....	18
4	Sound velocity measurements	19
4.1	Operate Valeport MIDAS SVP	19
4.2	SVP editor	20
5	Post Processing in CARIS HIPS.....	23
5.1	Create a new project.....	24
5.2	Convert raw data	25
5.3	Save session	25
5.4	Clean auxiliary sensor data.....	26
5.5	Sound velocity correction (Optional)	26
5.6	Load Tide	26
5.7	Merge	26
5.8	Process swath data	26
5.9	Define new field sheets.....	27
5.10	Generate BASE surface.....	27
5.11	Export data	27
6	Tips and tricks	28
6.1	Planning survey lines in SIS	28



6.2	Line spacing	29
7	Appendix	31
7.1	Latest Service and Calibration Report HE523 (14.-15.02.2019).....	31

History

Version / Date	Description
1.0 / 03.03.2010	First version
1.1 / 15.02.2013	Chapter 2.3 Sensor layout / alignment: Update of location offsets
1.2 / 15.04.2013	Added Chapter 3.11, External Triggering
1.3 / 05.02.2014	Added Chapter 3.3, background data
1.4 / 26.11.2014	Added Chapter 3.10, INS heave calculation
1.5 / 02.09.2016	GPS sensor naming & EM710 calibration parameters
1.6 / 17.02.2017	Updated position for GPS sensor "Trimble"; new calibration report (7.1); new chapter 3.12 on how to use VNC
1.7 / 05.03.2019	New calibration report
1.8 / 02.03.2020	New calibration report



1 Introduction

This manual intends to give the scientific user of the multibeam echosounder system on board RV “Heincke” a brief overview including the configuration, operation and a quick step-through for data processing in CARIS HIPS.

2 Hardware configuration

2.1 Sensor equipment

The following sensors are installed on the FS “Heincke”:

Table 1: Sensor specifications

Sensor	Model	Details from Manufacturer
Inertial Navigation System (INS)	IXSEA PHINS III	Heading accuracy: 0.05 deg (without aiding) Roll, Pitch accuracy: 0.01 deg Heave accuracy: 5 cm or 5%
Primary Positioning Sensor	Trimble SP461	Primary Positioning system DGPS 0.5 – 3 m accuracy
Backup Positioning Sensor	SAAB R5	Backup Positioning system DGPS GPS: 3m, DGPS: 1m (2D RMS)
Thermosalinograph (TSG)	Seabird SBE21+SBE38	Provides calculated sound velocity
Sound Velocity Transducer Probe (SVT)	Valeport miniSVS	Range: 1375 – 1900 m/s Resolution: 0.001 m/s, Accuracy: ± 0.02 m/s
Sound Velocity Profiling Probe (SVP)	Valeport MIDAS	Range: 1375 – 1900 m/s Resolution: 0.001 m/s, Accuracy: ± 0.02 m/s

2.2 Sensor structure

Figure 1 shows the sensor structure of the multibeam echosounder hardware. The processing unit is the main unit which controls the transmitter, gets the sounding data from the receiver, and receives position information from the Trimble DGPS receiver as well as attitude data (heading, roll, pitch, heave, velocity-z) from Ixsea PHINS III inertial navigation system (INS). Sound velocity at transducer level is provided by the thermosalinograph (TSG) via DSHIP. A backup sensor is a sound velocity transducer (SVT) probe. For measuring vertical sound velocity profiles in the water column you may use the shipboard CTD or the sound velocity profiling probe (SVP).

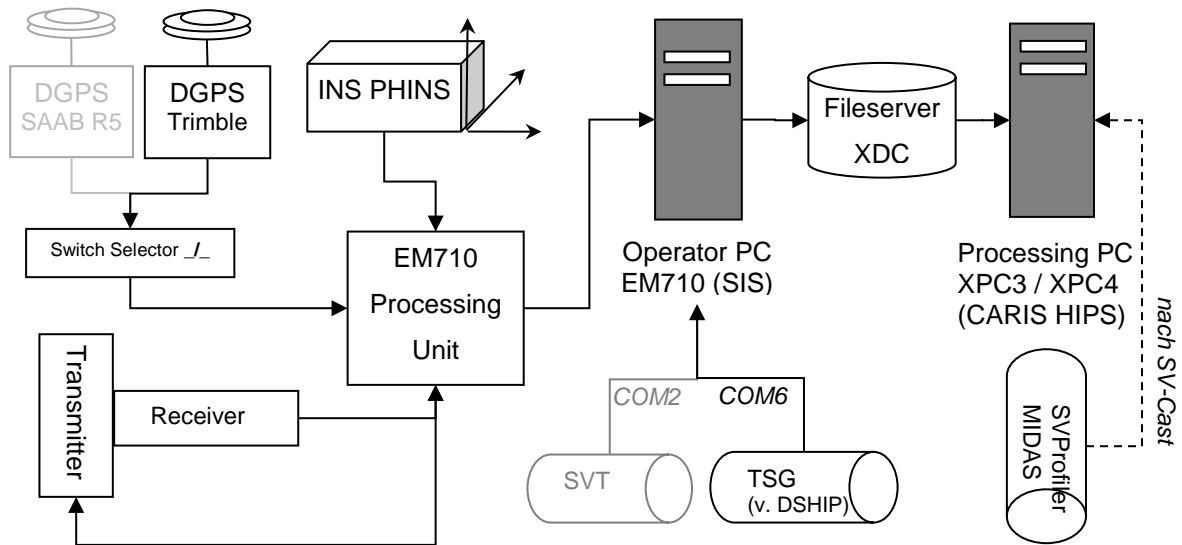

Figure 1: Sensor dependencies

2.3 Sensor layout / alignment

The sensor layout and alignment has been measured by the surveying company Overath & Sand Ship Surveyors. The Inertial Navigation System (INS) is located in the coordinate origin. All offsets of the transmitting transducer (TX), the receiving transducer (RX) and the GPS-Antennas refer to the INS position:

Location offset (m)			
	Forward (X)	Starboard (Y)	Downward (Z)
Pos, COM1/MCAST1:	13.649	2.976	-11.406
Pos, COM3/MCAST2:	0.00	0.00	0.00
Pos, COM4/UDP2/MCAST3:	0.00	0.00	0.00
TX Transducer:	17.709	1.037	4.961
RX Transducer:	16.987	1.156	4.963
Attitude 1, COM2/UDP5:	0.00	0.00	0.00
Attitude 2, COM3/UDP6:	0.00	0.00	0.00
Waterline:			1.18
Depth Sensor:	0.00	0.00	0.00

Figure 2: Location offsets



The angular misalignment of the transducer and transmitters with respect to the INS:

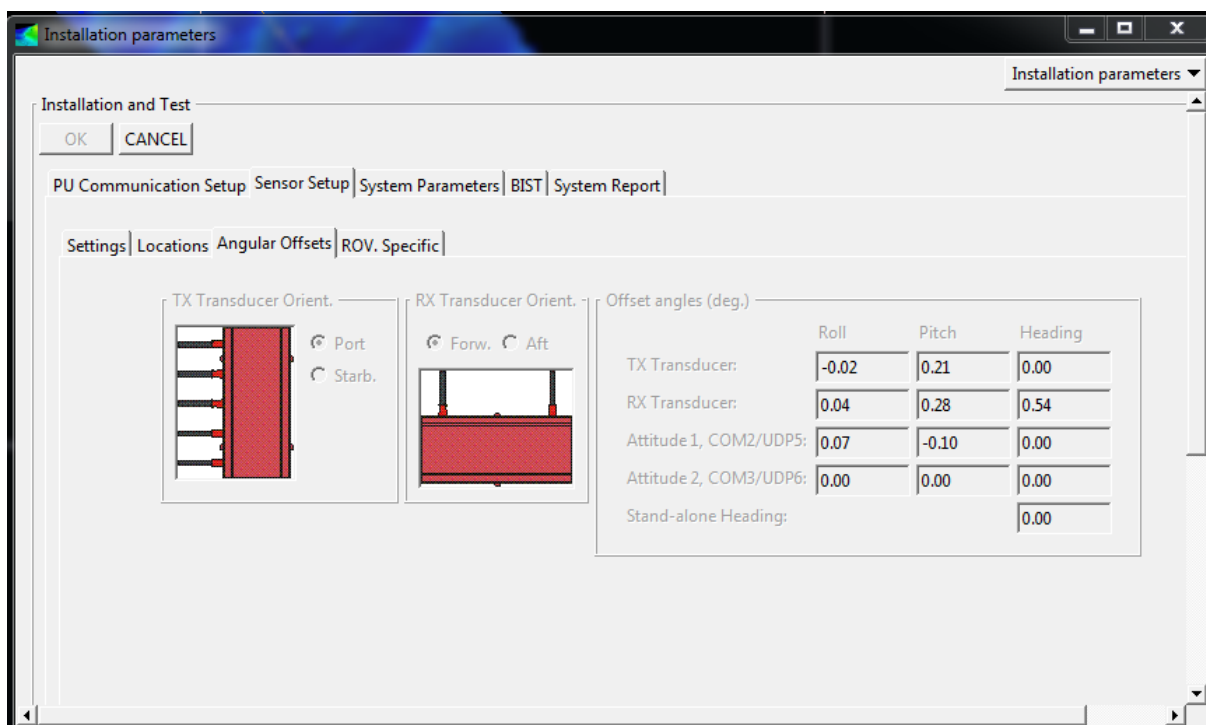

Figure 3: Angular offsets

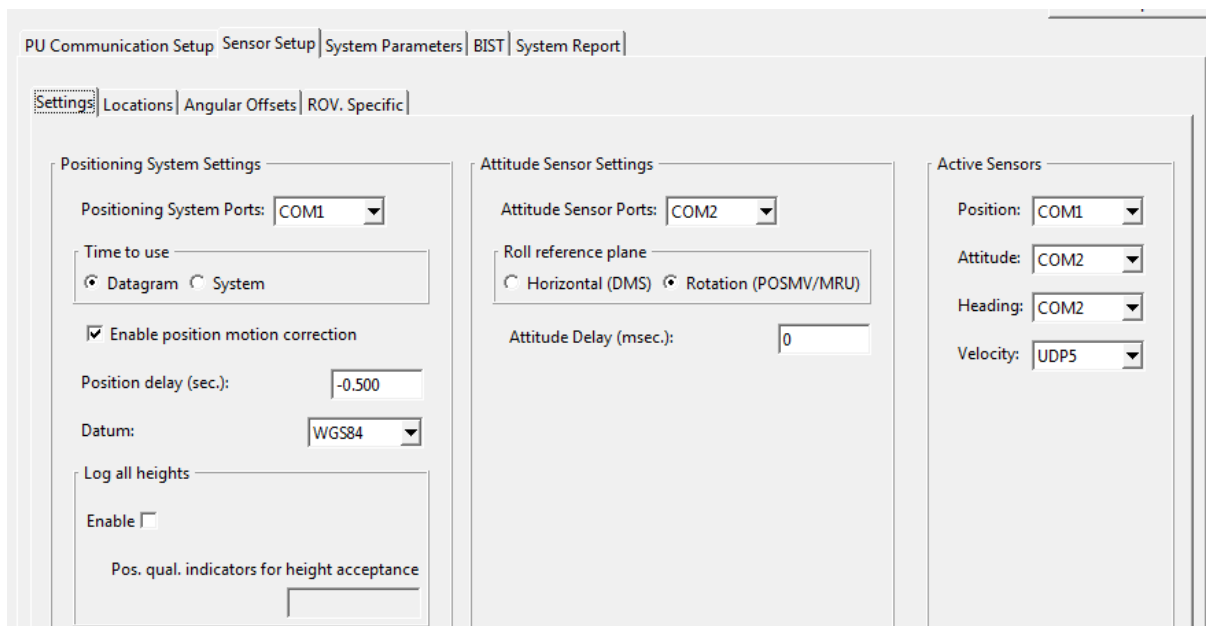

Figure 4: Sensor Setup Settings



3 SIS – Kongsbergs Acquisition Software

Figure 5 shows the normal sequence of operations required for survey runs using SIS.

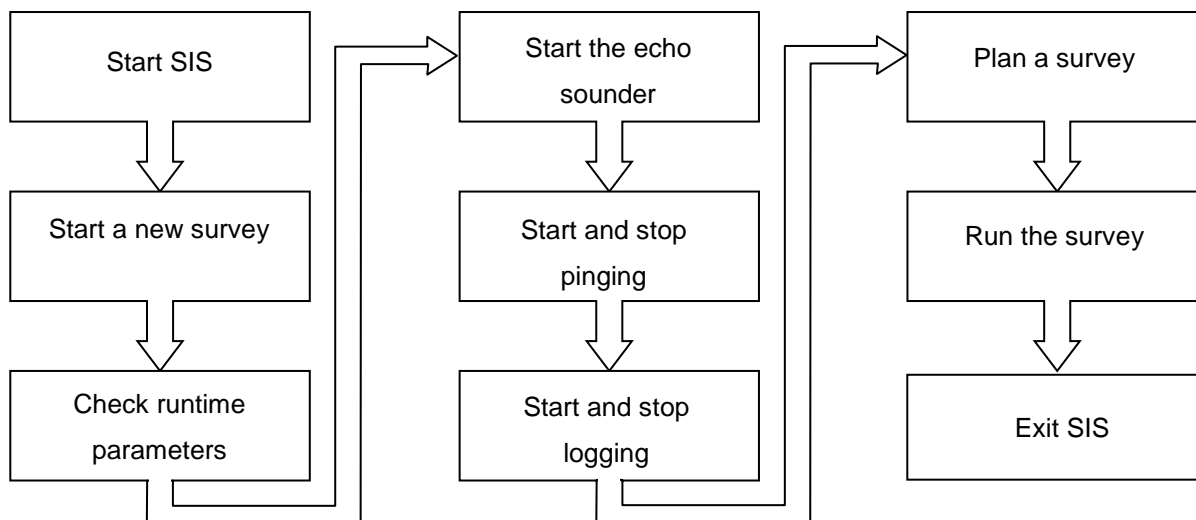

Figure 5: Workflow diagram for survey runs with SIS

3.1 Start SIS (SIS Operator Manual - page 94)

- Power up the echo sounder units (*by captain*)
- Power up the Operator Station peripherals (*by captain*)
- Power up the SIS Operator Station
(*for the SIS dongle, username and password please ask the captain*)
 - The operating system on the SIS Operator Station loads automatically. When the boot process is finished, the SIS program can be opened
- Click on the SIS icon on the desktop or select SIS from the Windows start menu

3.2 Start a new survey

(Referring SIS Operator Manual - page 95)

To create a new survey project at the beginning of a new expedition open the **New survey** frame (Figure 6).

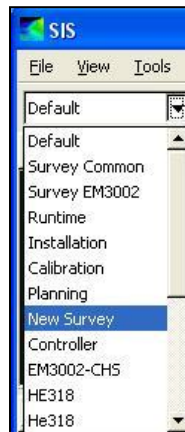

Figure 6: Open the New Survey frame

Important **New Survey** parameters to set are:

- **New survey name:** Select **Basic parameters** and enter a unique new survey name descriptive to the survey (Figure 7).

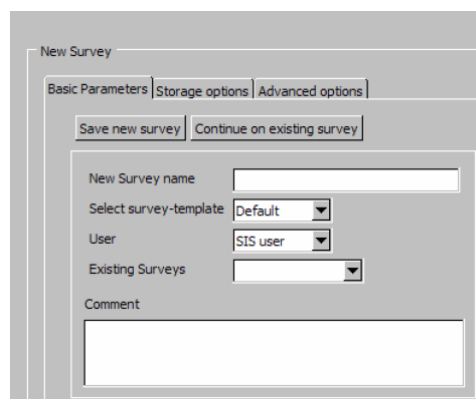

Figure 7: Basic parameters display

- **Map projection:** Select **Advanced options/Projection** (Figure 8, left). Select the applicable projection from the drop-down list. For the North Sea the map projection should be either **UTM31N_WGS84** or **UTM32N_WGS84** depending on the working area (Figure 8, right).

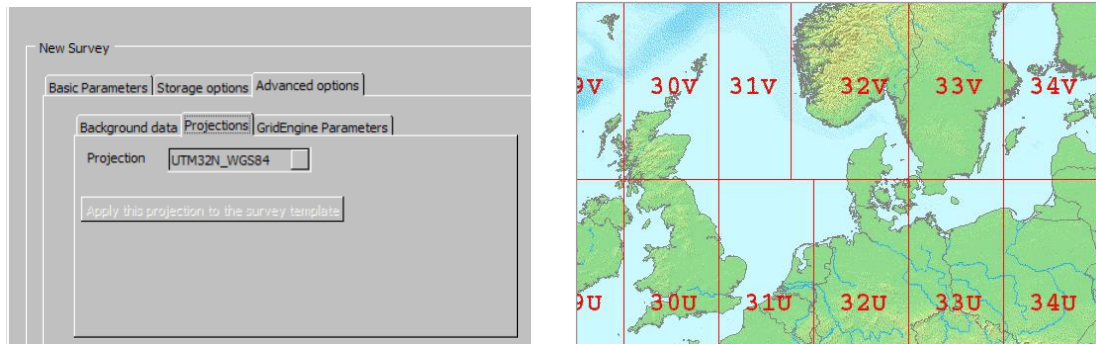

Figure 8: (left) Projections display - (right) UTM cells in the North Sea

- **Cell size:** Select **Advanced options/GridEngine parameters**. Select what depth to display and resolution of the grid, i.e. number of cells and cell size, suitable for the depth and expected coverage (Figure 9). The grid cell size is determined by the average swath width.

Normal resolution: Cell size = average_swath_width / 100
 Number of cells = 64 x 64

High resolution: Cell size = average_swath_width / 200
 Number of cells = 128x128

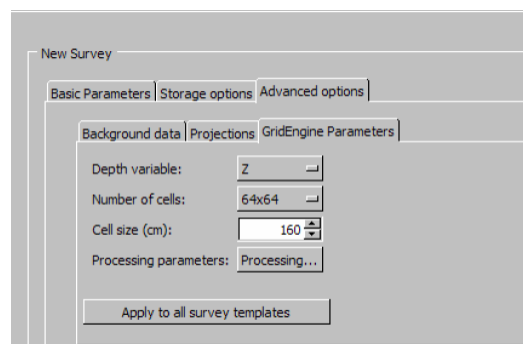

Figure 9: GridEngine Parameters display

When finished, press **Save new survey** (Figure 7).



3.3 Using background data

To display background data such as coastlines, the data needs to be imported into the SIS geographical view.

- First open the import/export window. (**File -> Import/Export...**)
From the different **Data Types** select **Background Images** and press **Import**. (Figure 10)
- In the **Backgroundimage Information window**, the path to the background data which should be imported must be specified. After selecting a file, the image size, the pixel scale and the bounding coordinates are displayed. Press **Ok** to continue.
- The imported image will now be shown in the Import/Export window. Press **Ok** again to finish importing the background data. The image is now displayed in the SIS **geographical view**.

To remove background data from SIS go back into the **Import/Export window** select the item you wish to remove from Background Images and press **Remove Selected**.

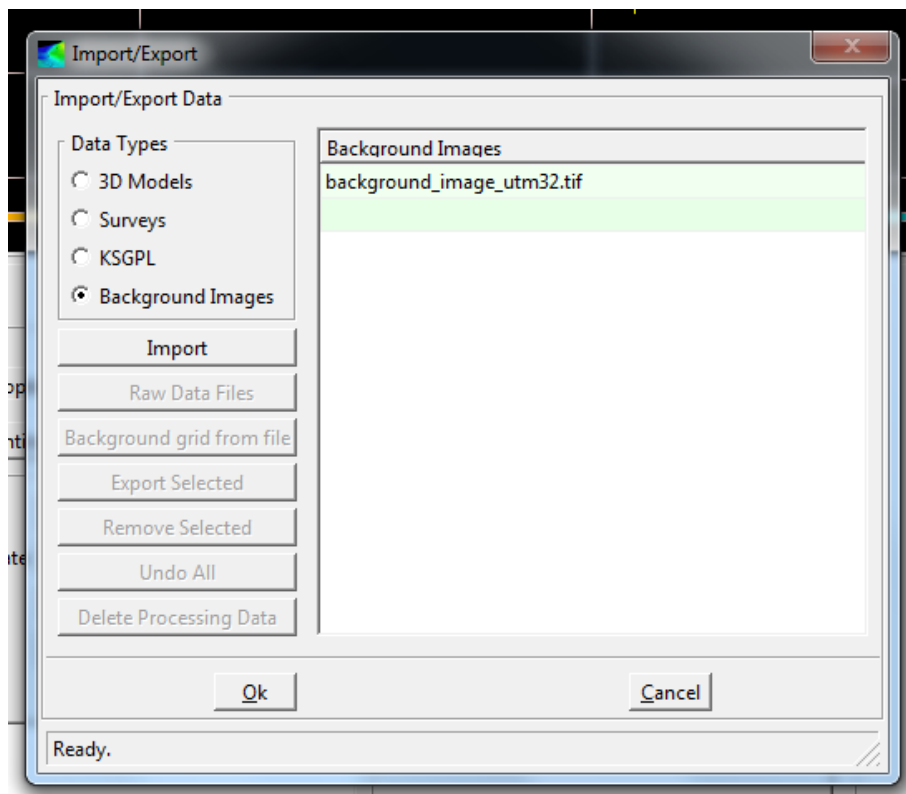

Figure 10: Import/Export display



A background image file containing the European coastlines can be found on the SIS-Operator PC.

3.4 Check runtime parameters

(Referring SIS Operator Manual - page 103)

The runtime parameters are associated with the echo sounder and not with the survey (Figure 11).

Important Runtime parameters to set are:

- **Maximum angle:** Select **Sounder Main**. Under **Sector Coverage/ Max. Angle** the maximum swath width can be defined by setting the maximum port and starboard angles. The maximum angle possible is 65°. Recommend is an angle between 45° and 55° depending on the sea state.
- **Depth settings:** Select **Sounder Main**. Make sure that the **Minimum Depth** and **Maximum Depth** settings are appropriate limits for the survey area or at least for the current location where the survey is planned to start. If the real depth is beyond these limits, the echosounder will not find the seafloor!
- **Ping Mode:** Select **Sounder Main**. Under **Depth settings/Ping Mode** the operational mode of the EM710 is defined. The Ping Mode should be set to **AUTO**.
- **Select SVP profile:** Select **Sound Speed**. The sound speed profile parameter allows to select the sound speed profile to be used in the echo sounder's depth calculations (See also Chapter 4.2).

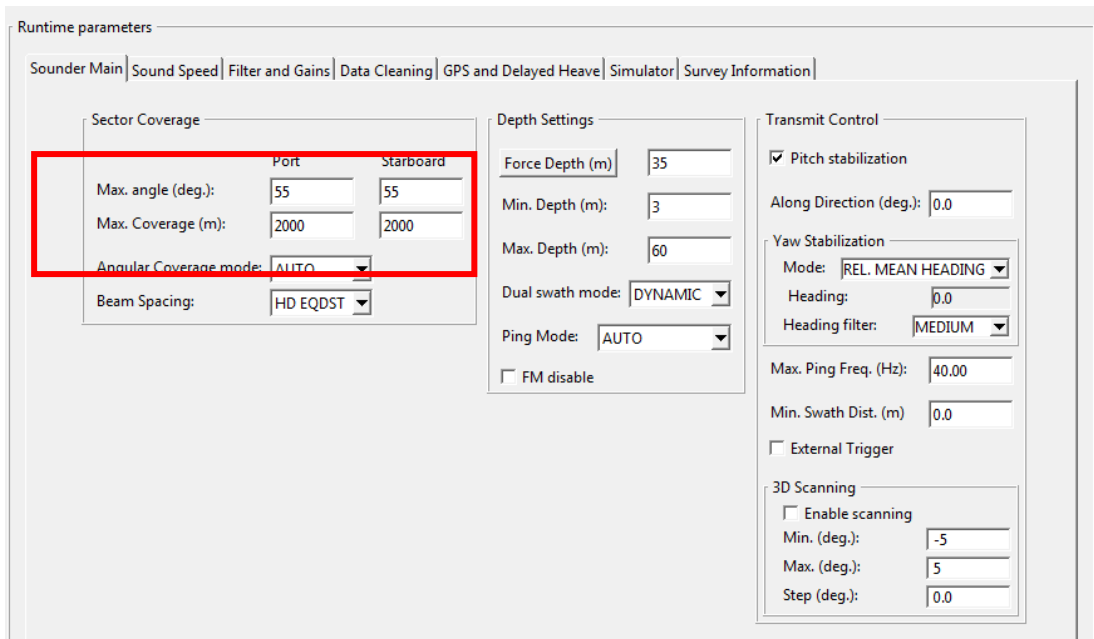

Figure 11: Runtime parameters display

3.5 Start the echo sounder

(Referring SIS Operator Manual - page 126)

Before starting pinging, the echo sounder must be turned on. Select the echo sounder from the **Echo sounder - not started** combo box (Figure 12). The **Logging** and **Pinging** buttons will all be disabled until the echo sounder is ready. When the echo sounder is ready, pinging can be started.

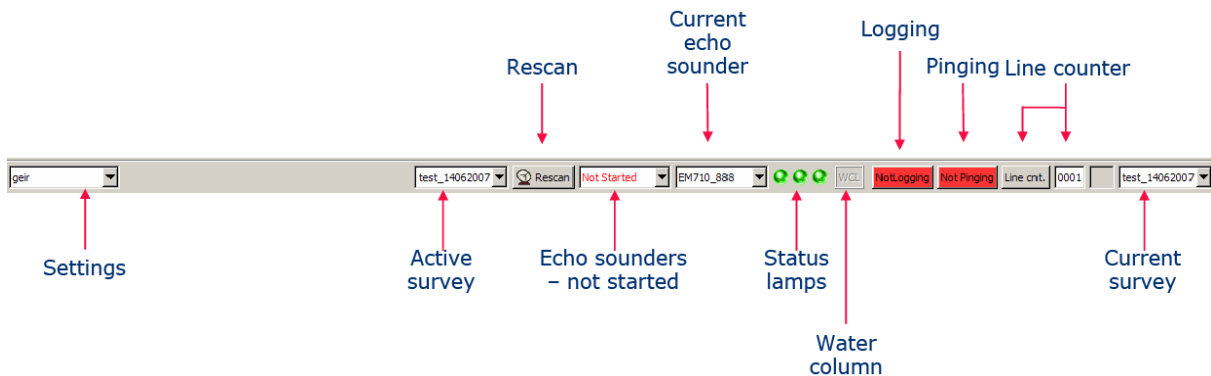

Figure 12: The main frame



3.6 Start and stop pinging

(Referring SIS Operator Manual - page 128)

Pinging must be started manually after the echo sounder is ready. Press the **Pinging** button on the toolbar. The button is red when **Off** and green when **On** (Figure 12).

3.7 Start and stop logging

(Referring SIS Operator Manual - page 133)

Logging must be started manually after the echo sounder is ready. When the echo sounder has started logging, data is automatically saved to disk in *.all file format (Figure 12).

Note that if pinging is **Off** when logging is turned **On**, pinging will automatically be turned **On**. If logging is **On** and pinging is turned **Off**, logging will automatically be turned **Off**.

For logging the water column data press the **WCL** button on the toolbar it will turn from grey to red if logging is enabled and will turn green during logging (Figure 12). This data will be written to *.wcd files in your selected folder, separately from the *.all files.

Warning: Water column data will be much larger than the default multibeam data (1 to 2 GB per hour extra). Please make sure to move these files regularly from the acquisition PC.



3.8 Plan a new job

(Referring SIS Operator Manual - page 156)

The planning module allows creating survey lines in the area to be surveyed. The planning module can be activated by clicking **P** in the toolbar at the top of the screen. With this tool survey lines can be created which the vessel must sail.

Please note, that all drawing and selecting commands are performed by pressing CTRL & left mouse button. To end all kind of drawings, confirm the changes by clicking CTRL & right mouse button and accept.

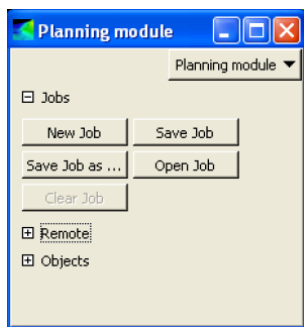

Expand **Jobs** (Figure 13):

- Press **New job** and enter a descriptive name of the job
- Select the preferred coordinate format

Figure 13: Planning module to start a new job

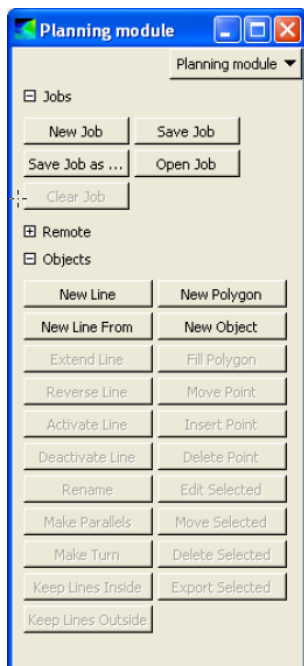

Expand **Objects** (Figure 14):

- Select **New line, New polygon, New line** from or **New object** depending on the survey plan
- Select the end points of the object by pointing the mouse in the geographical view, hold the Ctrl button while clicking on the left mouse button
- Hold the Ctrl button while clicking on right mouse button to bring up the confirm changes menu
- Press **Accept** to finish the object
- Press the **New line, New polygon, New line** from or **New object** again to finish the process

Figure 14: Before any object is created and selected, these are the possible options

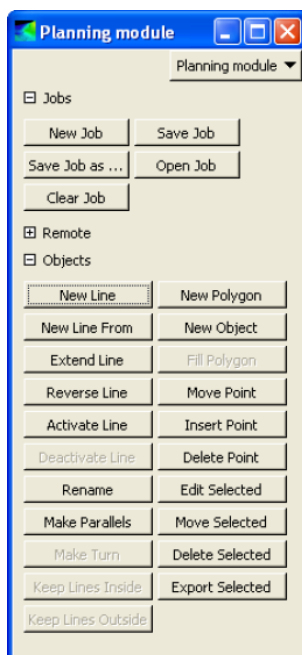

Select one of the planned lines or objects by **ctrl + left mouse** button:

- *Edit, move, extend, reverse, make parallel lines, etc.* according to the survey plan (Figure 15)

Press **Save Job** or **Save Job as**.

See also chapter 6.1 Planning survey lines in SIS

Figure 15: When an object is created and selected these are the new possible options

3.9 Run the survey

(Referring SIS Operator Manual - page 159)

On board of RV "Heincke" the raw multibeam data will be stored under ***E:\sisdata\raw\...*all***.

Load Job:

- Open the **Planning module** frame
- Expand **Jobs**
- Press the **Open job** button
- Select the file where the planned survey lines are stored
- Expand **Remote**
- Press **Transfer plan** so send the planned lines and objects to the remote helmsman display

During the survey:

- Observe the **Geographical window** which gives an overall control of the performance of SIS and the multibeam echo sounder.



- Observe logging, pinging and line number status on the right hand side of the toolbar.
- Observe the **Numerical display**, where the sensor data values can be monitored.
- Observe the three status lamps on the main toolbar which give status of hardware units (applies to multibeam echo sounders only) (Figure 12).
- Observe the **Cross track** display. The **cross track** window shows the measured depths in all beams from the last ping. If it forms a smiley or a frown the sound velocity profile is not suitable anymore and as a result wrong depths are calculated.

3.10 Change INS parameters for heave calculation

The parameters for the heave calculation and filter can and should be adapted to the current sea state. Open the IXSea PHINS III interface in the browser (http://phins/setup_navigation/) and select one of the following sea states (Figure 16):

- Slight Sea (<1.2m)
- Moderate Sea (<2.5m)
- Rough Sea (>2.5m)
- Harbors and Channels

Figure 16: change heave parameters in the INS interface

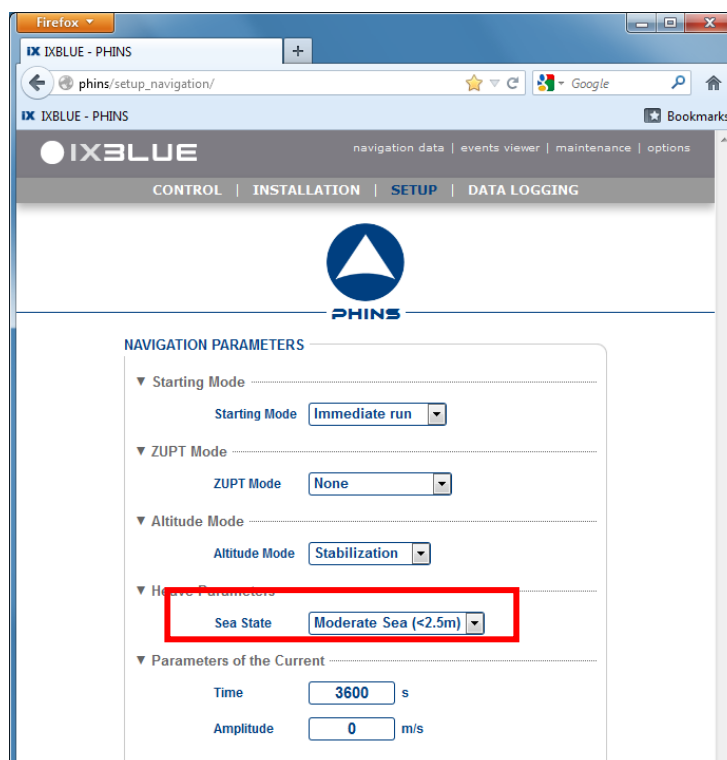



3.11 Interferences and External Triggering

Echosounders may interfere with other hydroacoustic systems such as other echosounders, ADCPs, Doppler velocity log of the vessel, etc. and also with general ship's noise like engines, propellers or sea water pumps. Especially echosounders operating at the same or the multiple of the EM710 transmission/reception frequencies (70 to 100 kHz) are potential interferers. If you receive a lot of erroneous data from the EM710 especially in the inner beam section and in continuous intervals you should consider switching off other instruments. On RV Heincke the following instruments could or do interfere with the EM710:

- Navigation sounder (Navlot) at 50 kHz
- Scientific fishery echosounder EK80 at 38, 70, 120 and/or 200kHz
- ADCP 150 kHz and ADCP 600 kHz
- Underwater Positioning System GAPS at 22 to 30 kHz
- Sediment echosounder SES2000 at 100 kHz and 5-15 kHz

To avoid sounding interferences with the Sub Bottom Profiler SES2000 it is possible to synchronize the pinging between SES2000 and EM710 by use of an external trigger (Figure 17). The external trigger signal is configured in the SES2000 software (compare FIELAX Manual RV Heincke_SubBottomProfiler_Support.pdf, Chapter 3 Synchronisation with Multibeam Echosounder EM710). **Caution:** If this checkbox is checked without running SES2000 and its activated trigger, no pinging with EM710 will be possible!

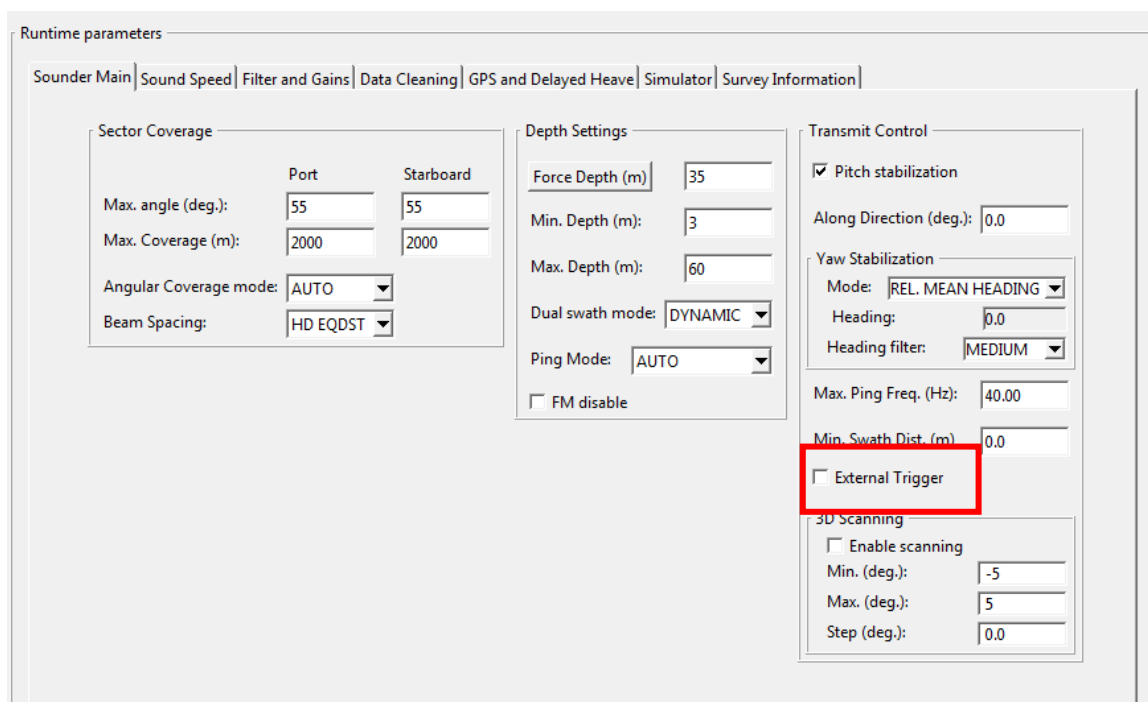
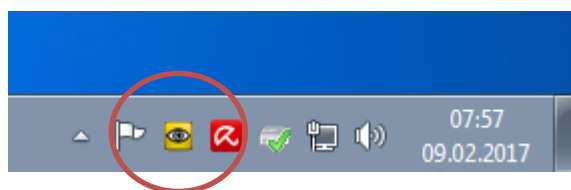

Figure 17 - External Trigger enabling/disabling in SIS

3.12 Remote Control / Watch using VNC

To remote control or watch the EM710 operator PC the software VNC is installed on the operator PC as a service. The operator PC's host name is EM710, ip address is 192.168.150.55. The password can be set in the settings menu of VNC (right click on icon below, Admin Settings):



Using VNC client software you may connect to this PC. It is installed on the EK60-PC at the bridge officer's starboard panel and at the XPC3 in dry lab.



4 Sound velocity measurements

On board of RV “Heincke” sound velocity profiles can be measured using the Valeport MIDAS SVP probe, which is stored in the dry lab.

We strongly recommend measuring a sound velocity profile before starting a new survey. Depending on the survey area, duration and purpose this should be repeated regularly.



4.1 Operate Valeport MIDAS SVP

The Valeport program **Data Log Express** is installed on the computer **xpc3** in the dry lab (**username: mbesadmin, password: please ask the captain**).

Preparation of the probe in the lab:

- Connect the SV probe with the computer (xpc3) on the serial COM port
- Start **Data Log Express**
- Connect to the probe
- Check the settings
- Select **OFFLINE** acquisition mode
- Start the acquisition with **RUN**
- Remove the serial cable and put on the dummy plug

!!!! With the dummy plug on the probe is online and uses up the batteries !!!!

Measurement in the water:

- Lower the SV probe to the desired depth
- Heave it back on deck
- Rinse the probe with clear water and dry the probe

Data export:

- Dry the connectors and remove the dummy plug
- Connect the serial cable again to the computer's serial COM port



- Start **Data Log Express**
- **Upload** the data file (*.000) to the computer. This is a plain text ASCII file that contains the measured sound velocity values over depth. This file can be imported to the SVP Editor in SIS (see next chapter)
- Disconnect the SV Probe from the PC and secure safely in the case. **DO NOT PUT ON THE DUMMY PLUG.**

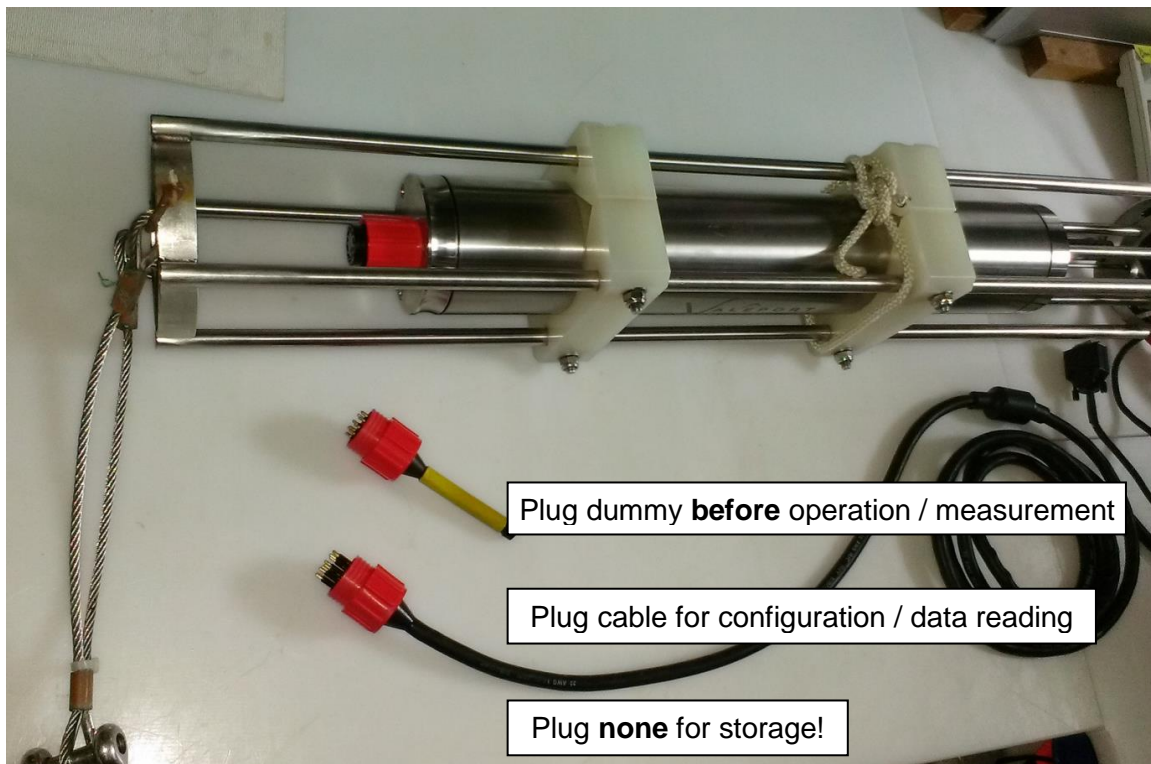

4.2 SVP editor

(Referring SIS Operator Manual - page 123)

By using the SVP editor any column based ASCII format file can be converted to the *.asvp format read by SIS.

Open the **SVP Editor** from the SIS menu (**Tools/Custom/SVP Editor**):

- Expand the view by dragging the boundaries of the window

Open the SVP file (**File/Open in editor**):

- Browse for the SVP input file and press **Open**. The **Raw file editor** opens



- Select the delimiter from the drop down list. Choose “<tab>”. (Figure 18)

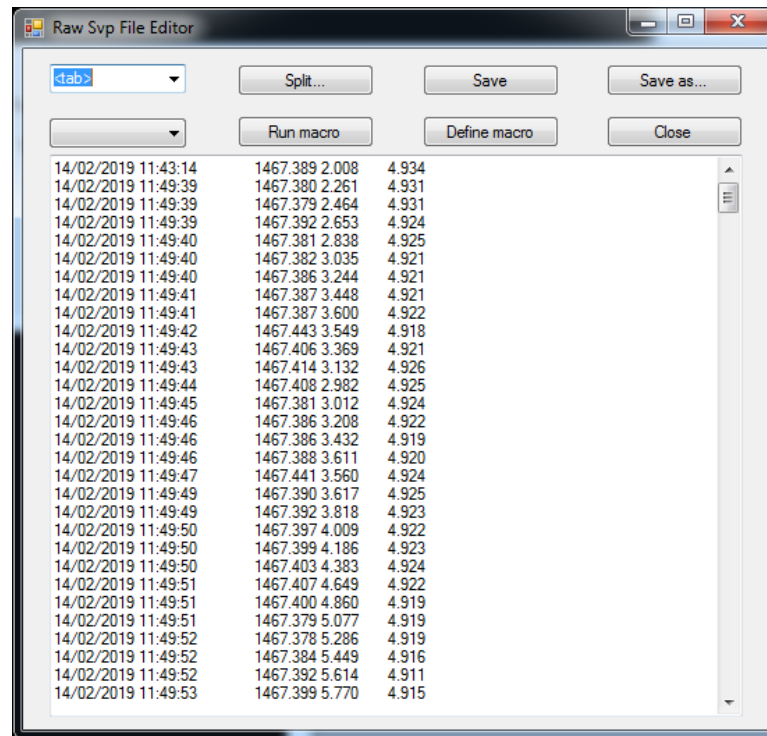

Figure 18: Choose delimiter

- Press **Split** to apply the delimiter A new window will appear
- Delete the header and mark the columns not needed. Position the mouse in the first data row to mark that column
- Press **Delete selected columns** to remove the marked columns (Figure 19)

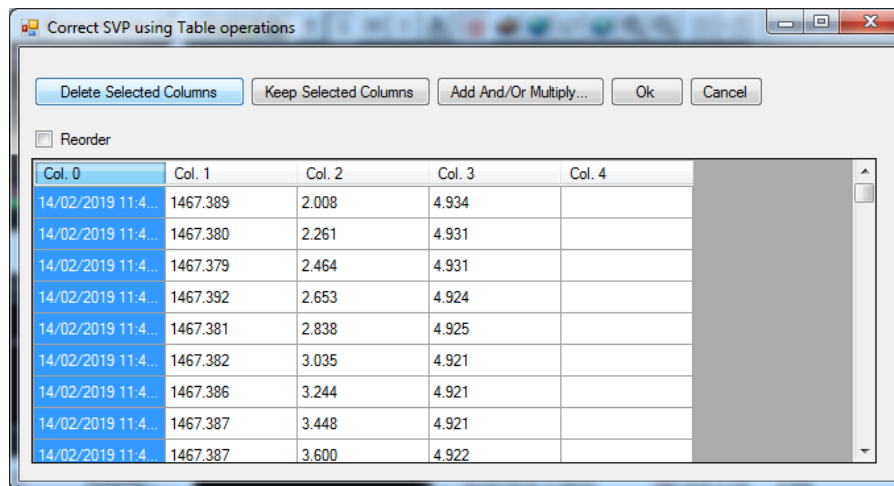

Figure 19: Delete unnecessary columns

- Move the columns by position the mouse pointer on the column header row and drag the column to right position. The “Record” checkbox has to be checked (Figure 20)

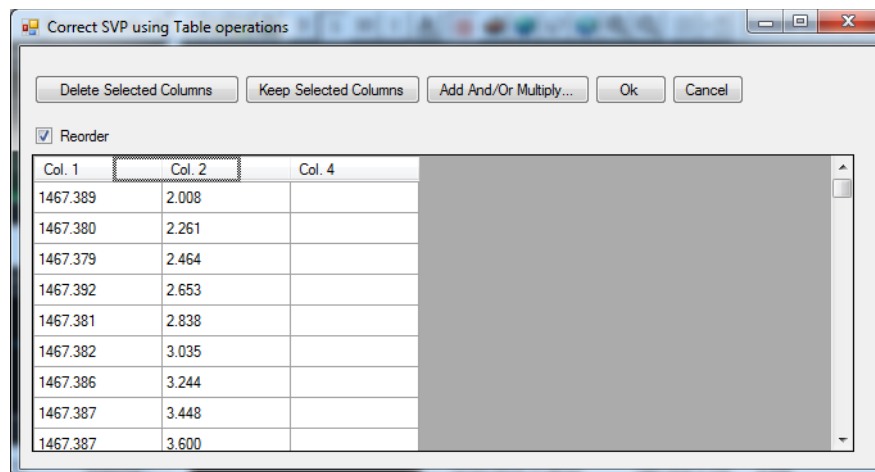

Figure 20: Move columns

- Press **OK** when selected columns are in right place
- Back in the **Raw file editor** remove all header rows by marking them and press **Delete**
- Select **Save as** - the file extension is automatically set to ***.asvp**

Now the sound velocity profile can be loaded into SIS and checked for errors.



Open the **SVP Editor** from the SIS menu (**Tools/Custom/SVP Editor**):

- Expand the view by dragging the boundaries of the window

Open the ***.asvp (File/Open)** menu:

- Check the observations for double entries or upward depths by choosing **Tools/Check profile automatic**.
- Press “extend” in the Menu to extend the SVP to 12000 m depth, which is necessary for SIS

Save the file from the **File/Save as** menu. It is recommended to use a filename that identifies date and time.

Select **Runtime parameters/Sound speed**:

- Use the browse button to open the correct ***.asvp** file
- Press **Use Sound Speed Profile** to apply the selected sound speed profile

Runtime parameters

Sounder Main | Sound Speed | Filter and Gains | Data Cleaning | GPS and Delayed Heave | Simulator | Survey Information

Sound Speed Profile

Use Sound Speed Profile: 20140116_HE413_SVP4.asvp

Abs. coeff. files, salinity: D:\sisdata\common\svp_abscoeff\20140116_HE413_SVP4_salini

Abs. coeff. files, CTD: D:\sisdata\common\svp_abscoeff\default

Sound Speed at Transducer

Source: PROFILE

Sound Speed (m/sec.): 1500.0

Sensor Offset (m/sec.): 0.0

Filter (sec.): 3

Depth/Pressure Sensor

Scaling: 1.00 Manual override

Offset: 0.00 Manual override

Set Sensor Depth (m):

Figure 21: Select sound speed profile

5 Post Processing in CARIS HIPS

The processing software Caris HIPS is installed on the computers **xpc3** and **xpc4** (**username: mbesadmin**). For the **dongle** and the **password** please ask the captain.



Before processing the data copy the raw data from the SIS Operator station to the Data Processing Station via the Netstorage Server *xdc*. Figure 22 shows the most important steps for cleaning multibeam data. Also refer to *HIPS and SIPS 6.1 SP2 - Quick Reference for Multibeam data* and *HIPS and SIPS User's Guide*.

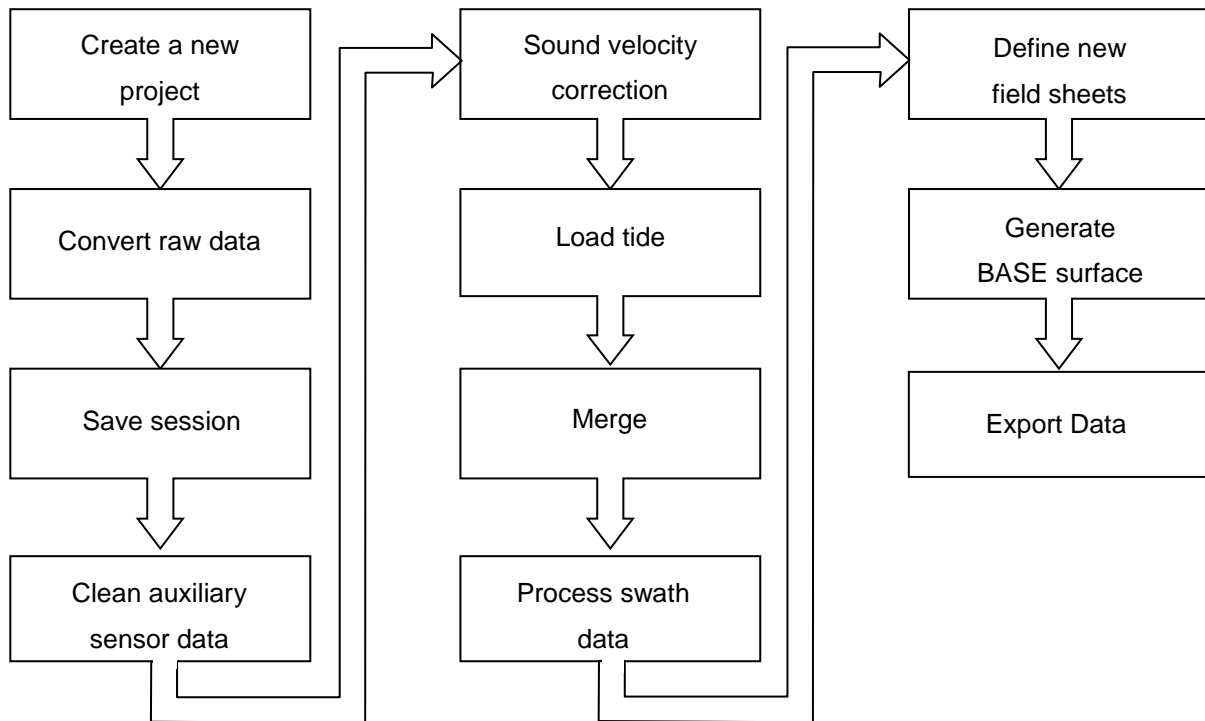

Figure 22: Workflow diagram for processing multibeam data

5.1 Create a new project

(Referring HIPS & SIPS User's Guide - page 125)

To create a new project-Vessel-Day directory tree structure to store data go to **File/Project/New** and enter a new project name, the vessel and the first day of the survey in Julian Day (number of day in a year, 001-365).



5.2 Convert raw data

(Referring HIPS & SIPS User's Guide - page 170)



Copy the raw-data of SIS (*E:\sisdata\raw\...\.all*) to the CARIS-PC. HIPS and SIPS files are created from survey data using the Conversion Wizard. To start the conversion process, activate the HIPS **Conversion Wizard**.

1. Select the survey data format "**Simrad**" - Click **Next**
2. Pick the files to be converted - Click **Next**
3. Select the Project/Vessel/Day or raw data files and click **Open** - Click **Next**
4. Select the coordinate system (UTM 32N for German Bay) - Click **Next**
5. Enter range of extents. Automatically set to maximum range - Click **Next**
6. Start conversion by clicking **Next** (Figure 23)

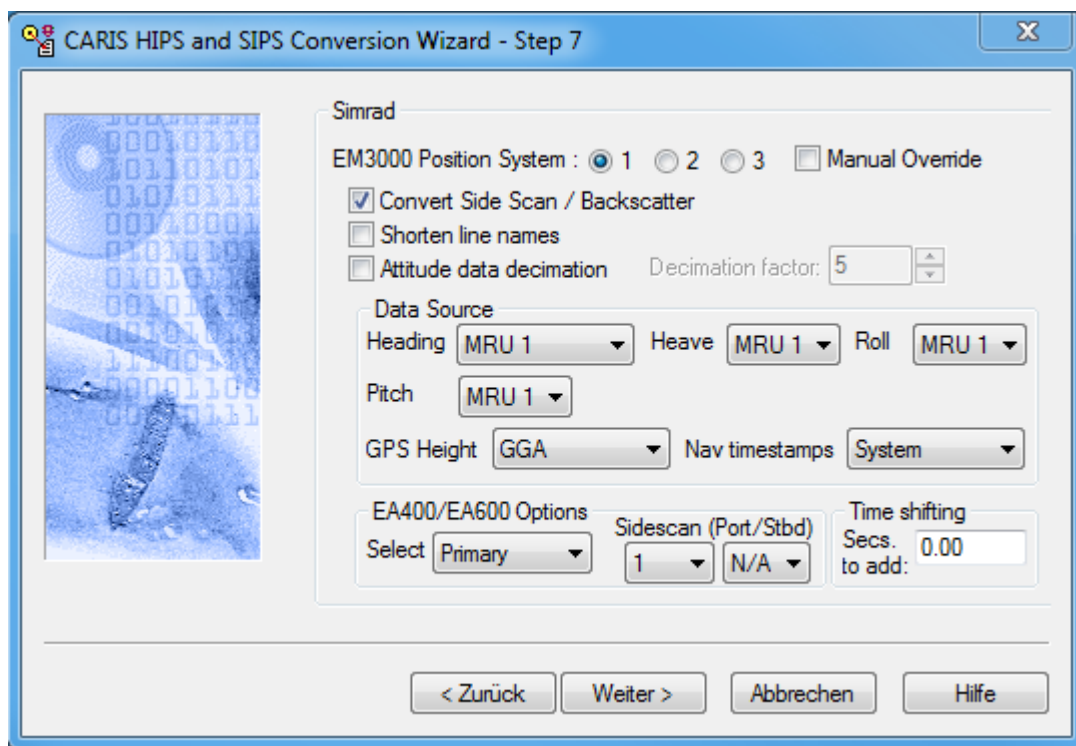

Figure 23: Step 7 of the Conversion Wizard

5.3 Save session

(Referring HIPS & SIPS User's Guide - page 159)

Save the currently open data as a session file (**File/Save Session As**).



5.4 Clean auxiliary sensor data

(Referring HIPS & SIPS User's Guide - page 261)



Open the **Navigation Editor** to view and clean the vessel's navigation data. Take a look at the navigation for each survey line to make sure, that no error in the GPS will affect the measured data. When detecting GPS errors mark them with the left mouse button and press either



Reject-With Interpolation or



Reject-Break Interpolation to remove outlier data.

When finished, save and close the navigation editor.

5.5 Sound velocity correction (Optional)



Only relevant if not already applied in SIS. Select the survey lines the sound velocity data shall be applied to and click **Sound Velocity Correction**. Select the respective *.asvp file and press **OK**.

5.6 Load Tide

(Referring HIPS & SIPS User's Guide - page 215)



Select the survey lines and press **Load Tide**. Select the respective *.tid file and press **OK**. Take the zero.tid file if you don't have a tide file.

NOTE: The tide file should have the following format:

Date (YYYY/DD/MM) Time (00:00:00) Tide (0.00) >> (2010/09/02 02:50:00 1.50)

5.7 Merge

(Referring HIPS & SIPS User's Guide - page 253)



To create a position/depth value for each sounding select a line or group of lines and press **Merge**. Lines must have tide loaded before they can be merged.

5.8 Process swath data

(Referring HIPS & SIPS User's Guide - page 299)



Open the **swath editor** to examine and clean soundings recorded by the multibeam system. With this tool it is possible to reject wrong bottom detection beams. It is possible to flag false beams and accept beams.

5.9 Define new field sheets

(Referring HIPS & SIPS User's Guide - page 349)

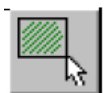

To define a new field sheet select **New Field Sheet**.

1. Type a name for the field sheet in the **Name** text box – Click **Next**
2. Select a map projection (**UTM-WGS84**) and zone for the field sheet - Click **Next**
3. Press the cross line button and define the field sheet extents by using the mouse to create a rectangle defining the extents– Press **Finish**

5.10 Generate BASE surface

(Referring HIPS & SIPS User's Guide - page 408)

To create a BASE surface (bathymetric grid), click on the field sheet – right mouse click – create BASE surface. Enter the desired resolution and foot print in pixel. Common settings are 2 m single resolution, surface type swath angle and a foot print of 9 pixels.

5.11 Export data

(Referring HIPS & SIPS User's Guide - page 585)

To export data go to **File/Export** (Figure 24). All possible export options are listed. For external use only, the exports *HIPS to ASCII*, *BASE Surface To ASCII* and *BASE Surface To Image* are recommended. Please note that an export can last several hours, in particular HIPS to ASCII, depending on data size.



Figure 24: CARIS HIPS and SIPS Export options

6 Tips and tricks

6.1 Planning survey lines in SIS

A survey is normally planned taking the following into account:

- Echo sounder coverage
- Seafloor topography
- Sound speed variations
- Weather conditions

Please note, that all drawing and selecting commands are performed by pressing CTRL & left mouse button. To end all kind of drawings, the changes must be confirmed by clicking CTRL & right mouse button and accept.

To create a new job click **New Job**, enter a descriptive name of the job and select the preferred coordinate format. Then a new line or polygon can be created – depending on the survey plan - by activating the corresponding button (**New Line/New Polygon**). The respective mode is active until another option is selected or the button is pressed once more. Create a new line or polygon by holding the CTRL key while clicking the left mouse button for each new point of the line or for each node in the polygon respectively. At the end click CTRL and the right mouse button to accept the operation. Lines/Polygons can be edited using **Edit selected**. Note that the object has to be selected first. Now it is possible to insert for example the exact coordinates of the line/polygon.



Fill Polygon

A polygon can be filled with lines with specific line spacing. Therefore a new line just outside but near the polygon has to be created. The length of the line should be related to the maximum extent of the polygon in this orientation. For filling the polygon select both the polygon and the line and press **Fill Polygon**. Now the distance and spacing between the parallel lines can be defined (both port and starboard directions). How to determine the line spacing is explained in the following chapter. Every line has a defined direction, marked with a square at the start of the line. To reflect the sailing, select every second line and press **Reverse Line**. When finished save the job (**Save Job**). The coordinates of the start- and endpoints of the new survey lines will be saved as a ASCII file under E:\sisdata\common\planning.

6.2 Line spacing

To determine the line spacing the achievable coverage of the multibeam echo sounder and the overlap required between neighbouring lines is required. The echo sounder coverage depends on the opening angle (α) of the multibeam and the water depth (h) (Figure 25).

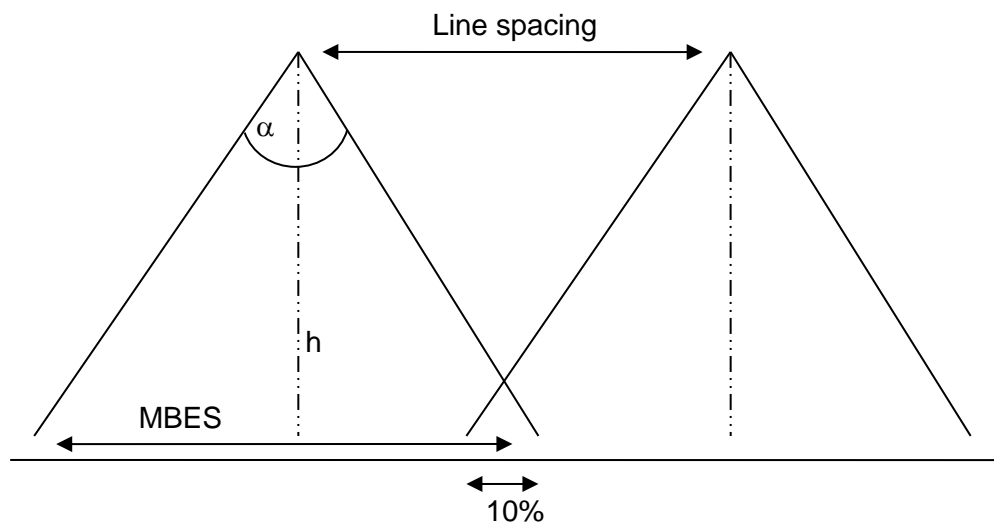

Figure 25: Important parameters for determining the line spacing



For a full coverage survey, including 10 % overlap, the line spacing can be calculated as follows:

$$\begin{aligned}\alpha &= 55^\circ \\ h &= 30 \text{ m} \\ \text{MBES coverage} &= \tan(55) \cdot 30 \cdot 2 = 85.7 \text{ m} \\ \text{Overlap (10\%)} &= 0.1 \cdot (\tan(55) \cdot 30) = 4.3 \text{ m} \\ \text{Line spacing:} &= \text{MBES coverage} - \text{Overlap} = 85.7 \text{ m} - 4.3 \text{ m} = 81.4 \text{ m}\end{aligned}$$

The vessel speed depends on the desired resolution and on the weather condition while acquiring the data. Typically a speed of 6 knots is appropriate.



7 Appendix

7.1 Latest Service and Calibration Report HE523 (14.-15.02.2019)

German only!

7.1.1 Übersicht

Die Reise HE523 der FS „Heincke“ wurde unter anderem als Erprobungsfahrt für durch Fa. FIELAX betreute Systeme genutzt. Die durchgeführten Arbeiten und Ergebnisse werden in diesem Bericht zusammengefasst.

Teilnehmer: FIELAX – Usbeck, Nehring, Dillon, Dimmler, AWI - Immoor, Krocker

Zeitraum: 04.- 05.02.2020

Ziel: Nordsee, Region Helgoland

Wetter: Sonnig, ~5-7 °C, Wind 180°-230° (W-NW) 5-6 Bft abflauend, Seegang anfangs 2-3m abflauend auf ca. 1m am 05.02.2020

7.1.2 Fächerlot Kongsberg EM710

Generelle Arbeiten:

- ✓ Testbetrieb und Datenaufzeichnung mit SIS
- ✓ Datenauswertung und –begutachtung mit SIS
- ✓ Aufräumen des Operator-PCs
- ✓ Aktualisierung des FIELAX Startup Manuals auf v1.7 und Upload in die AWI-Geräteakte

Fächerlot-Kalibrierung

Sowohl am 04.02. als auch am 05.02.2020 wurde für die Datenaufzeichnung der Kalibrierprofile ein aktuelles Wasserschallprofil resultierend aus den zuvor durchgeführten Messungen mit einer Sea & Sun CTD 778 verwendet . Um ausreichend Daten für eine gute Berechnung der Kalibrieroffsets für Latency/Zeitverzögerung, Pitch, Roll und Heading zu erhalten wurden insgesamt 11 Profile gemessen. Dabei wurden am 05.02.2020 Linien für die Pitch und Latency Korrektur wiederholt. Die Offsets für Latency / Zeitverzögerung (- 500 ms), Roll (+0,07°) und Heading (0°) wurden bestätigt. Für Pitch wurde eine Korrektur von -1° angebracht und der neue Offset für Pitch beträgt nun -0,1° (Änderung von +0.9° auf -0.1°).



Folgende Einstellungen müssen im „SIS / Installation Parameters“ eingetragen sein!



Abbildung 1: Aktuelle Einstellungen in SIS unter "Installation Parameters / Sensor Setup / Angular Offsets"



Abbildung 2: Aktuelle Einstellungen in SIS unter "Installation Parameters / Sensor Setup / Settings"

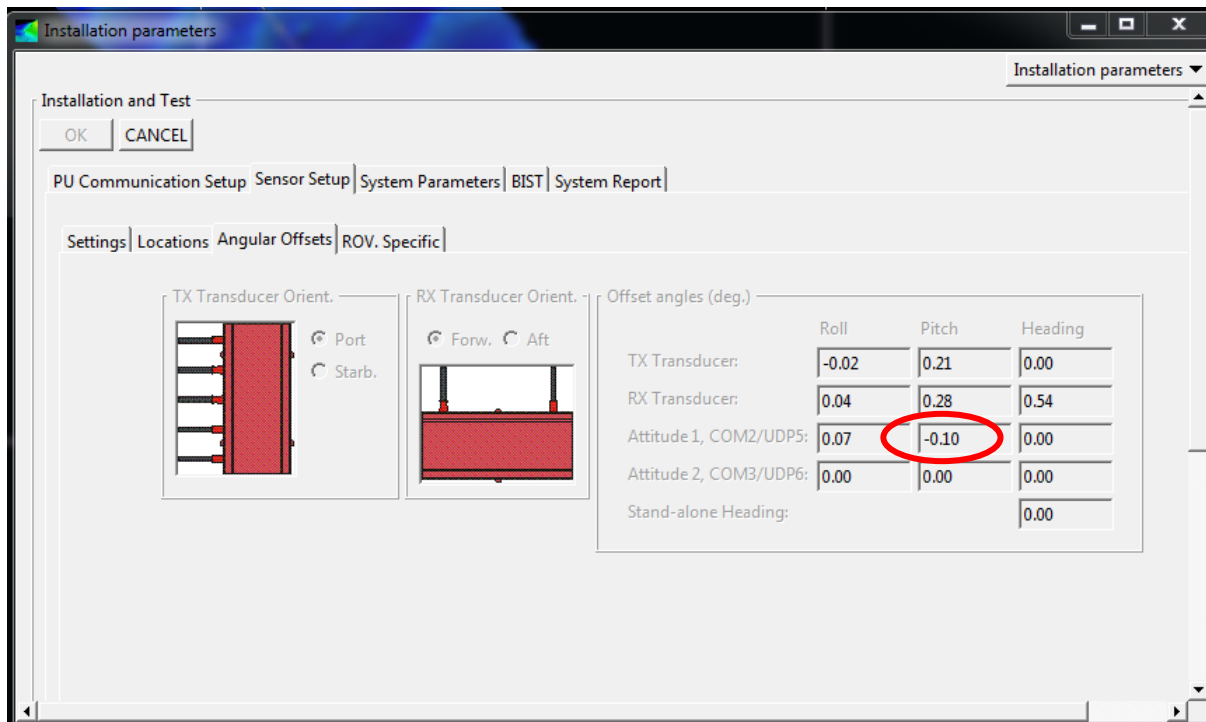

Ergebnis der Kalibrierung

Parameter	Vorjahr 2019	Aktuell
Position Latency	-500 ms	-500 ms
Roll	0,07°	0,07°
Pitch	0,90°	-0,1°
Heading	0,00°	0,00°

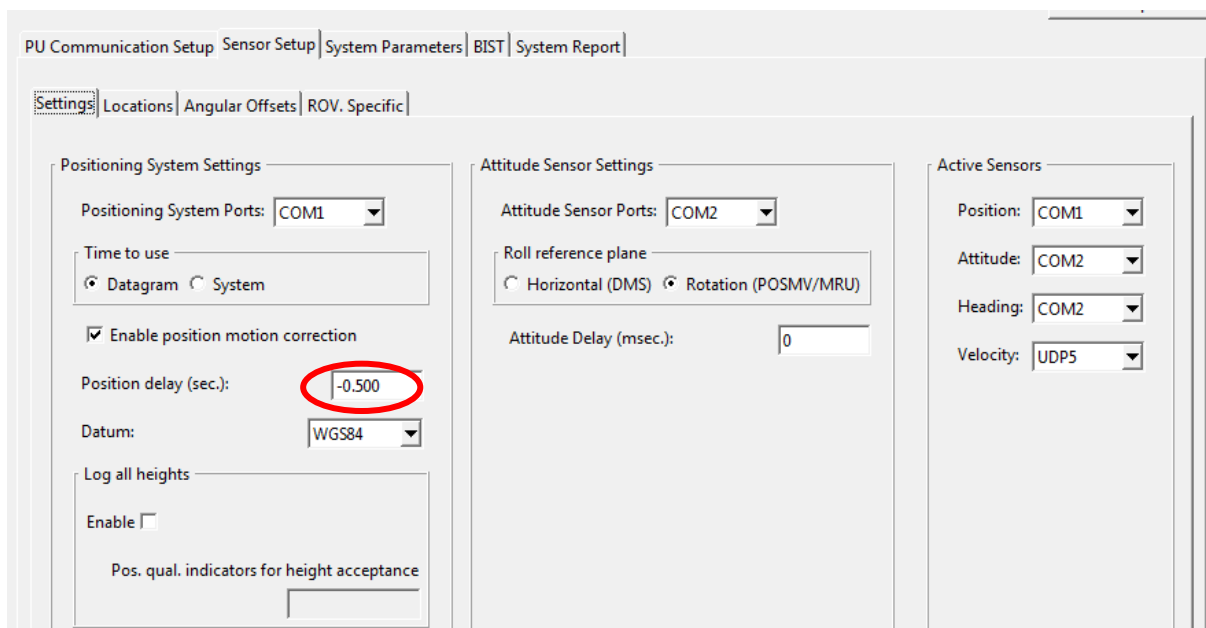
Abbildung 3: Ergebnisse der Fächerlot-Kalibrierung 2020

Hintergrundkarte für SIS

Zur groben Orientierung gibt es für SIS eine Hintergrundkarte. Diese deckt die wesentlichen Fahrtgebiete von FS Heincke ab und enthält eine grobe Bathymetrie (Quelle BSH und GEBCO 2014) sowie Küstenlinien. Die Karte liegt als georeferenziertes TIFF in der Projektion UTM 32N in den Auflösungen 600 und 1200 dpi vor. Sie kann in SIS per „Load Background Data“ aus dem Ordner „d:\rawdata\common\background“ importiert werden.



Abbildung 4: Hintergrundkarte für SIS zur Orientierung



7.1.3 Details zur Kalibrierung des Fächerlots EM710



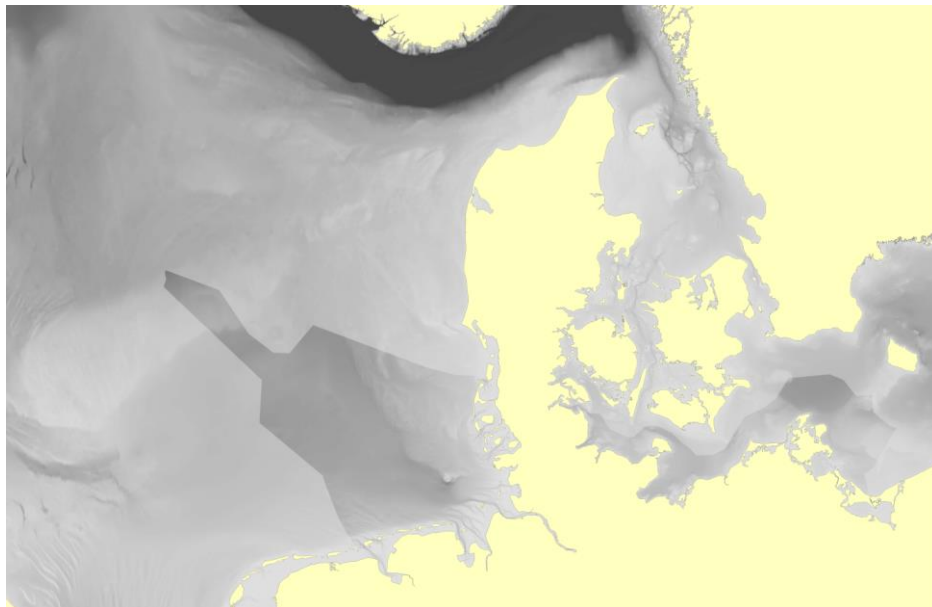
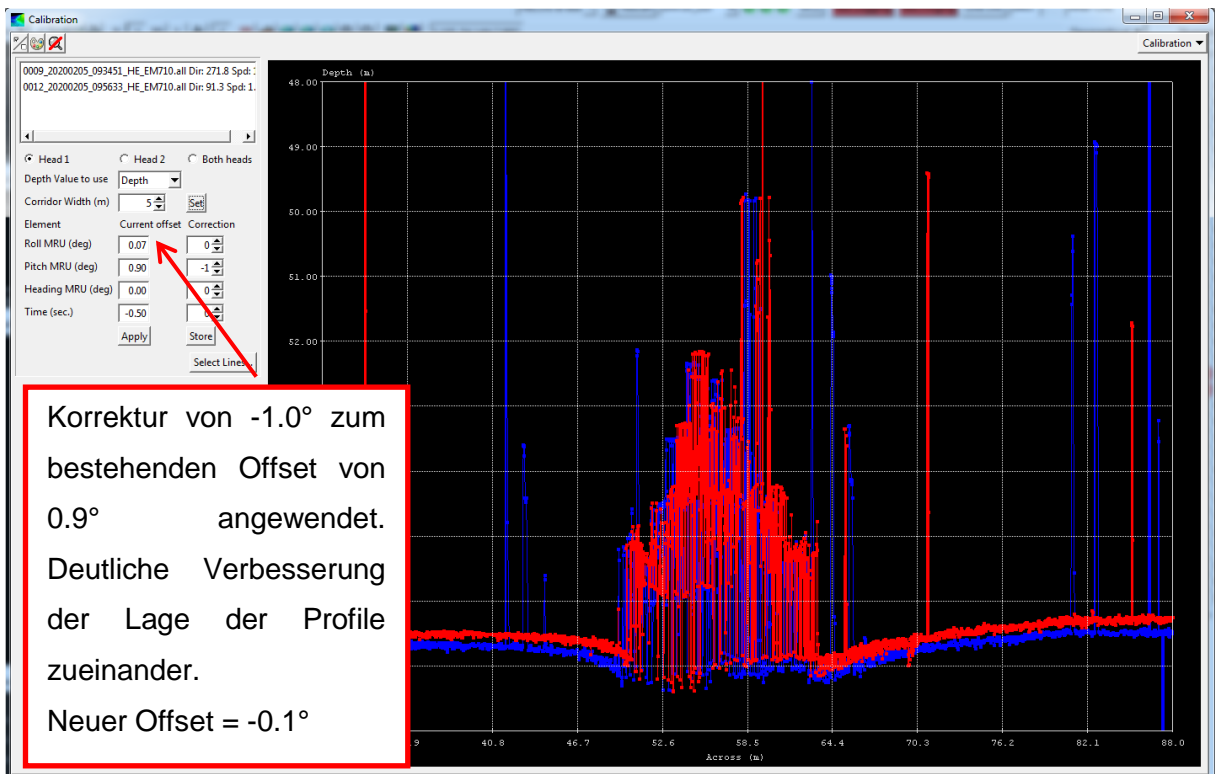
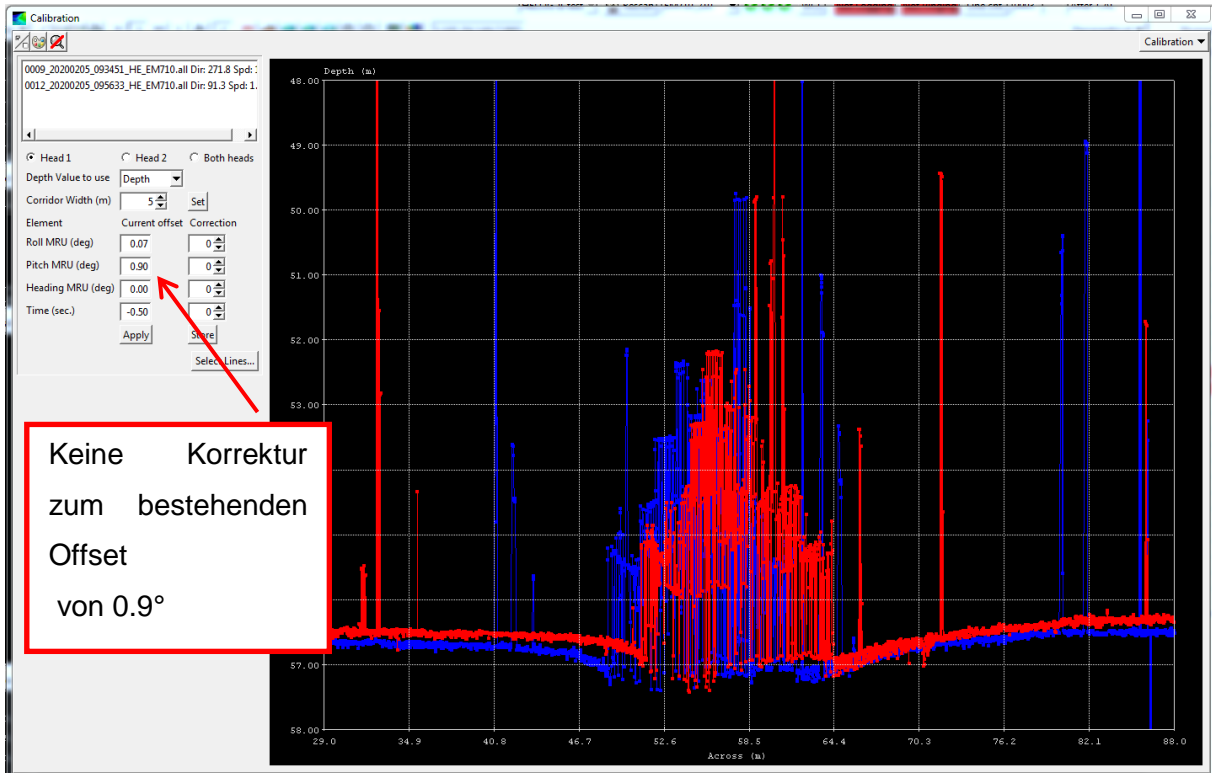

Kalibrierprofilplanung:

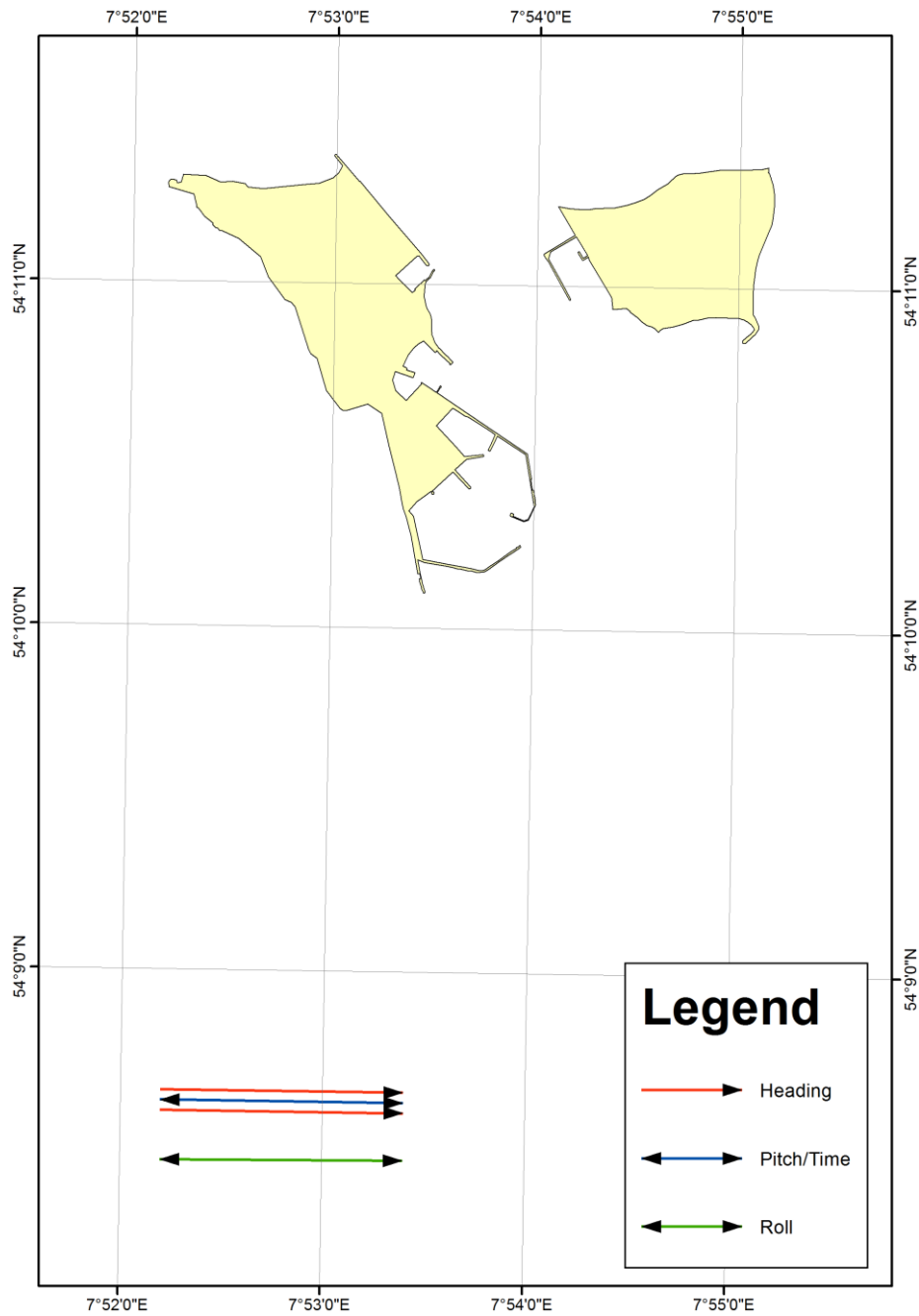

Abbildung 5: Übersichtskarte der Kalibrierungsprofile für das EM710 südlich von Helgoland



Profilliste:

Datum	Uhrzeit	Latitude / Longitude Start	Latitude / Longitude Ende	Speed [kn]		
04.02.2020						
Roll 1	13:14 – 13:21	54.140767 / 7.870000	54°8.446' N / 7°52.2' E	54.140883 / 7.890000	54°8.453' N / 7°53.4' E	6,0
Roll 2	13:28 – 13:36	54.140883 / 7.890000	54° 8.453' N / 7°53.4' E	54.140767 / 7.870000N	54°8.446' N / 7°52.2' E	6,0
Pitch 1	13:39 – 13:46	54.143667 / 7.869967	54°8.620' N / 7°52.198' E	54.143667 / 7.890000	54°8.620' N / 7°53.400' E	6,0
Pitch 2	13:53 – 14:00	54.143667 / 7.890000	54°8.620' N / 7°53.400' E	54.143667 / 7.869967	54°8.620' N / 7°52.198' E	6,0
Heading 1	14:06 – 14:13	54.143167 / 7.869967	54°8.590' N / 7°52.198' E	54.143167 / 7.890000	54°8.590' N / 7°53.400' E	6,0
Heading 2	14:36 – 14:43	54.144167 / 7.869967	54°8.650' N / 7°52.198' E	54.144167 / 7.890000	54°8.650' N / 7°53.400' E	6,0
05.02.2020						
Pitch / Latency	09:35 - 09:48	54.143667 / 7.890000	54°8.620' N / 7°53.400' E	54.143667 / 7.869967	54°8.446' N / 7°52.200' E	3,0
	09:56 - 10:08	54.143667 / 7.869967	54°8.446' N / 7°52.200' E	54.143667 / 7.890000	54°8.620' N / 7°53.400' E	3,0
	10:17 - 10:21	54.143667 / 7.890000	54°8.620' N / 7°53.400' E	54.143667 / 7.869967	54°8.446' N / 7°52.200' E	9,0
	10:25 - 10:30	54.143667 / 7.869967	54°8.446' N / 7°52.200' E	54.143667 / 7.890000	54°8.620' N / 7°53.400' E	9,0