

Brief Operating Instructions

Proline Promag 50

Electromagnetic flowmeter

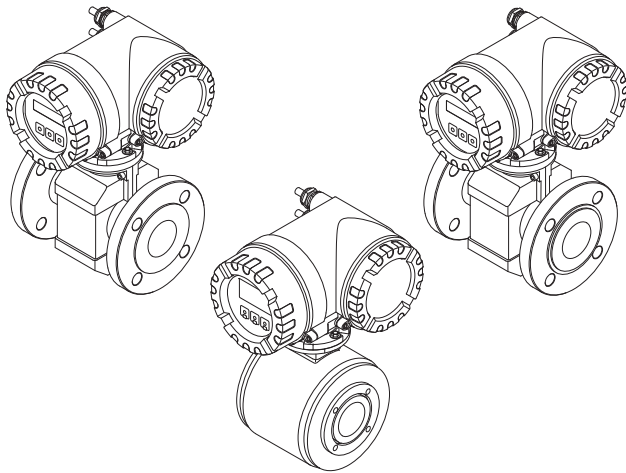

These Brief Operating Instructions are not intended to replace the Operating Instructions provided in the scope of supply. Detailed information is provided in the Operating Instructions and the additional documentation on the CD-ROM supplied.

The complete device documentation consists of:

- These Brief Operating Instructions
- Depending on the device version:
 - Operating Instructions and the Description of Device Funct.
 - Approvals and safety certificates
 - Special safety instructions in accordance with the approvals for the device (e.g. explosion protection, pressure equipment directive etc.)
 - Additional device-specific information

Table of contents

1	Safety instructions	4
1.1	Designated use	4
1.2	Installation, commissioning and operation	4
1.3	Operational safety	4
1.4	Safety conventions	6
2	Installation	7
2.1	Transporting to the measuring point	7
2.2	Installation conditions	8
2.3	Installing the Promag E sensor	13
2.4	Installing the Promag H sensor	17
2.5	Installing the Promag L sensor	19
2.6	Installing the Promag P sensor	25
2.7	Installing the Promag W sensor	31
2.8	Installing the transmitter housing	39
2.9	Post-installation check	42
3	Wiring	43
3.1	Connecting the various housing types	44
3.2	Connecting the remote version connecting cable	45
3.3	Potential equalization	48
3.4	Degree of protection	49
3.5	Post-connection check	49
4	Hardware settings	50
4.1	Device address	50
4.2	Terminating resistors	52
5	Commissioning	53
5.1	Switching on the measuring device	53
5.2	Operation	54
5.3	Navigating within the function matrix	55
5.4	Calling the Commissioning Quick Setup	56
5.5	Software settings	57
5.6	Troubleshooting	57

1 Safety instructions

1.1 Designated use

- The measuring device is to be used only for measuring the flow of conductive liquids in closed pipes. A minimum conductivity of 20 $\mu\text{S}/\text{cm}$ is required for measuring demineralized water. Most liquids can be measured as of a minimum conductivity of 5 $\mu\text{S}/\text{cm}$.
- Any use other than that described here compromises the safety of persons and the entire measuring system and is, therefore, not permitted.
- The manufacturer is not liable for damage caused by improper or non-designated use.

1.2 Installation, commissioning and operation

- The measuring device must only be installed, connected, commissioned and maintained by qualified and authorized specialists (e.g. electrical technicians) in full compliance with the instructions in these Brief Operating Instructions, the applicable norms, legal regulations and certificates (depending on the application).
- The specialists must have read and understood these Brief Operating Instructions and must follow the instructions they contain. If you are unclear on anything in these Brief Operating Instructions, you must read the Operating Instructions (on the CD-ROM). The Operating Instructions provide detailed information on the measuring device.
- The measuring device should only be installed in a de-energized state free from outside loads or strain.
- The measuring device may only be modified if such work is expressly permitted in the Operating Instructions (on the CD-ROM).
- Repairs may only be performed if a genuine spare parts kit is available and this repair work is expressly permitted.
- If performing welding work on the piping, the welding unit may not be grounded by means of the measuring device.

1.3 Operational safety

- The measuring device is designed to meet state-of-the-art safety requirements, has been tested, and left the factory in a condition in which it is safe to operate. Relevant regulations and European standards have been observed.
- The manufacturer reserves the right to modify technical data without prior notice. Your Endress+Hauser distributor will supply you with current information and updates to these Operating Instructions.
- The information on the warning notices, nameplates and connection diagrams affixed to the device must be observed. These contain important data on the permitted operating conditions, the range of application of the device and information on the materials used.
- If the device is not used at atmospheric temperatures, compliance with the relevant marginal conditions as specified in the device documentation supplied (on CD-ROM) is mandatory.
- The device must be wired as specified in the wiring and connection diagrams. Interconnection must be permitted.

- All parts of the device must be included in the potential equalization of the system.
- Cables, certified cable glands and certified dummy plugs must be suitable to withstand the prevailing operating conditions, such as the temperature range of the process. Housing apertures that are not used must be sealed with dummy plugs.
- The device should only be used for fluids to which all the wetted parts of the device are sufficiently resistant. With regard to special fluids, including fluids used for cleaning, Endress+Hauser will be happy to assist in clarifying the corrosion-resistant properties of wetted materials. However, minor changes in temperature, concentration or in the degree of contamination in the process may result in variations in corrosion resistance. For this reason, Endress+Hauser does not accept any responsibility with regard to the corrosion resistance of wetted materials in a specific application. The user is responsible for the choice of suitable wetted materials in the process.
- When hot fluid passes through the measuring tube, the surface temperature of the housing increases. In the case of the sensor, in particular, users should expect temperatures that can be close to the fluid temperature. If the temperature of the fluid is high, implement sufficient measures to prevent burning or scalding.
- Hazardous areas
Measuring devices for use in hazardous areas are labeled accordingly on the nameplate. Relevant national regulations must be observed when operating the device in hazardous areas. The Ex documentation on the CD-ROM is an integral part of the entire device documentation.
The installation regulations, connection data and safety instructions provided in the Ex documentation must be observed. The symbol and name on the front page provides information on the approval and certification (e.g.  Europe,  USA,  Canada). The nameplate also bears the documentation number of this Ex documentation (XA***D/./..).
- For measuring systems used in SIL 2 applications, the separate manual on functional safety (on the CD-ROM) must be observed.
- Hygienic applications
Measuring devices for hygienic applications have their own special labeling. Relevant national regulations must be observed when using these devices.
- Pressure instruments
Measuring devices for use in systems that need to be monitored are labeled accordingly on the nameplate. Relevant national regulations must be observed when using these devices. The documentation on the CD-ROM for pressure instruments in systems that need to be monitored is an integral part of the entire device documentation. The installation regulations, connection data and safety instructions provided in the Ex documentation must be observed.
- Endress+Hauser will be happy to assist in clarifying any questions on approvals, their application and implementation.

1.4 Safety conventions

Warning!

"Warning" indicates an action or procedure which, if not performed correctly, can result in injury or a safety hazard. Comply strictly with the instructions and proceed with care.

Caution!

"Caution" indicates an action or procedure which, if not performed correctly, can result in incorrect operation or destruction of the device. Comply strictly with the instructions.

Note! "Note" indicates an action or procedure which, if not performed correctly, can have an indirect effect on operation or trigger an unexpected response on the part of the device.

2 Installation

2.1 Transporting to the measuring point

- Transport the measuring device to the measuring point in the original packaging.
- Do not remove the covers or caps until immediately before installation.

2.1.1 Transporting flanged devices DN ≤ 300 (12")

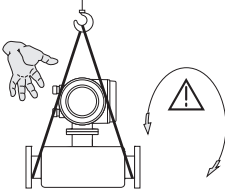

To transport the unit, use slings slung around the process connections or use lugs (if available).

Warning!
Risk of injury! The device can slip.
The center of gravity of the measuring device may be higher than the holding points of the slings.
Always ensure that the device cannot slip or turn around its axis.

A0007408

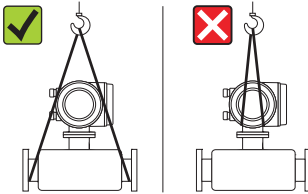

Do not lift measuring devices by the transmitter housing or the connection housing in the case of the remote version. Do not use chains as they could damage the housing.

A0007409

2.1.2 Transporting flanged devices DN > 300 (12")

Use only the metal eyes provided on the flanges to transport, lift or position the sensor in the piping.

Caution!

Do not attempt to lift the sensor with the tines of a fork-lift truck beneath the metal casing! This would buckle the casing and damage the internal magnetic coils.

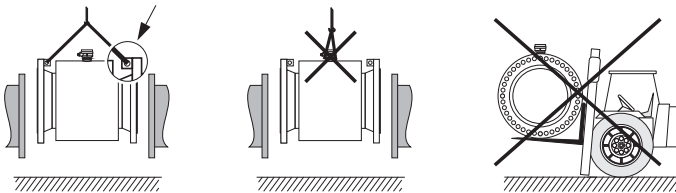

A0008153

2.2 Installation conditions

2.2.1 Dimensions

For the dimensions of the measuring device, see the associated Technical Information on the CD-ROM.

2.2.2 Mounting location

The accumulation of air or formation of gas bubbles in the measuring tube can result in an increase in measuring errors.

For this reason avoid the following mounting locations in the pipe:

- At the highest point of a pipeline. Risk of air accumulating!
- Directly upstream from a free pipe outlet in a down pipe.

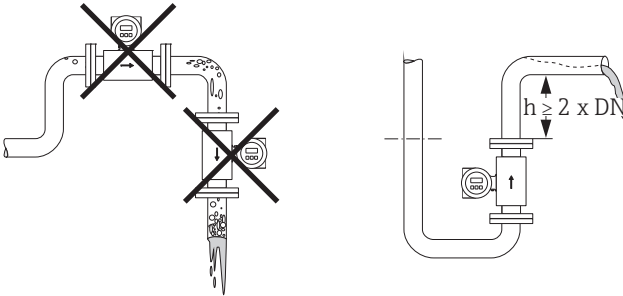

A0008154

Installation of pumps

Do not install the sensor on the intake side of a pump. This precaution is to avoid low pressure and the consequent risk of damage to the lining of the measuring tube. It might be necessary to use pulse dampers in systems incorporating piston pumps, piston diaphragm pumps or peristaltic pumps.

Information on the measuring system's pressure tightness and resistance to vibration and shock can be found in the Operating Instructions of the CD-ROM.

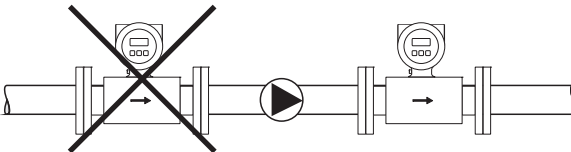

A0003203

Partially filled pipes

Partially filled pipes with gradients necessitate a drain-type configuration. The empty pipe detection (EPD) function offers additional protection by detecting empty or partially filled pipes.

 Caution!

Risk of solids accumulating! Do not install the sensor at the lowest point in the drain. It is advisable to install a cleaning valve.

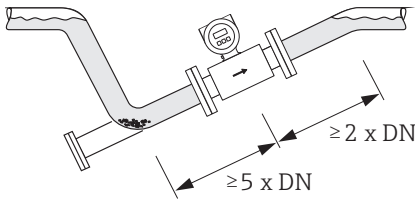

Installation in a partially filled pipe

A0008155

Down pipes

Install a siphon or a vent valve downstream of the sensor in down pipes longer than 5 meters (16 ft). This precaution is to avoid low pressure and the consequent risk of damage to the lining of the measuring tube. This measure also prevents the system losing prime, which could cause air pockets.

For information on the pressure tightness of the measuring tube lining, see the Operating Instructions on the CD-ROM.

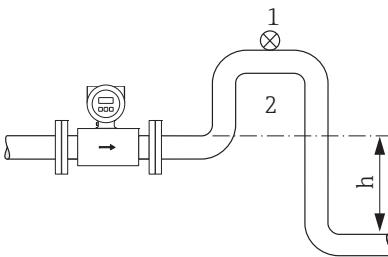

Measures for installation in a down pipe ($h > 5 \text{ m} / 16 \text{ ft}$)

1. Vent valve
2. Siphon

A0008157

2.2.3 Orientation

An optimum orientation helps avoid gas and air accumulations and buildup in the measuring tube. The measuring device, nevertheless, supplies a range of functions and tools to measure problematic fluids correctly:

- Electrode cleaning circuitry (ECC) to prevent electrically conductive deposits in the measuring tube, e.g. for fluids causing buildup
- Empty pipe detection (EPD) for detecting partially filled measuring tubes, e.g. in the case of degassing fluids or varying process pressures
- Exchangeable measuring electrodes for abrasive fluids (only Promag W)

Vertical orientation

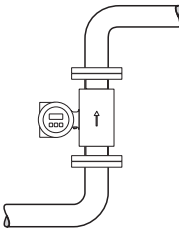

This orientation is optimum for self-emptying piping systems and when using empty pipe detection (EPD) or open electrode detection (OED).

A0008158

Horizontal orientation

The measuring electrode plane should be horizontal. This prevents brief insulation of the two electrodes by entrained air bubbles.

 Caution!

In the case of horizontal orientation, empty pipe detection only works correctly if the transmitter housing is facing upwards. Otherwise there is no guarantee that empty pipe detection will respond if the measuring tube is only partially filled or empty.

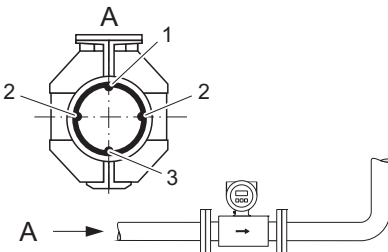

1. EPD electrode for empty pipe detection (not for Promag H, DN 2 to 15 / 1/2 to 1/2").
2. Measuring electrodes for signal detection
3. Reference electrode for potential equalization (not for Promag H)

A0008159

Inlet and outlet runs

If possible, install the sensor upstream from fittings such as valves, T-pieces, elbows, etc.

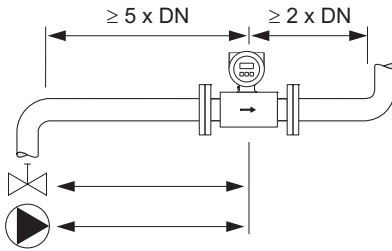

A0008160

The following inlet and outlet runs must be observed in order to meet accuracy specifications:

- Inlet run: $\geq 5 \times DN$
- Outlet run: $\geq 2 \times DN$

2.2.4 Vibrations

Secure and fix both the piping and the sensor if vibrations are severe.

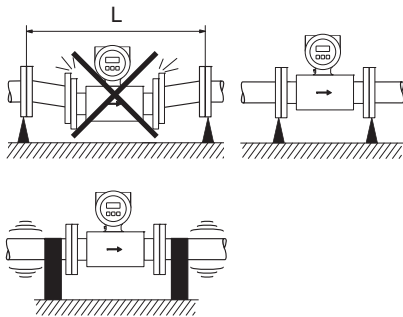

A0008161

Measures to prevent device vibration
($L > 10 \text{ m} / 33 \text{ ft}$)



Caution!

It is advisable to install the sensor and transmitter separately if vibration is excessively severe. For information on the permitted shock and vibration resistance, see the Operating Instructions on the CD-ROM.

2.2.5 Foundations, supports

If the nominal diameter is $DN \geq 350$ (14"), mount the sensor on a foundation of adequate load-bearing strength.

 **Caution!**
 Risk of damage! Do not support the weight of the sensor on the metal casing.
 This would buckle the casing and damage the internal magnetic coils.

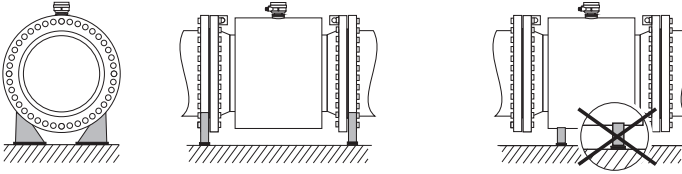

A0008163

2.2.6 Length of connecting cable

Comply with the following instructions in order to ensure correct measuring results:

- Secure the cable run or route the cable in an armored conduit. Movement of the cable can falsify the measuring signal, particularly if the fluid conductivity is low.
- Route the cable well clear of electrical machines and switching elements.
- Ensure potential equalization between the sensor and transmitter, if necessary.
- The permissible cable length L_{max} depends on the fluid conductivity.

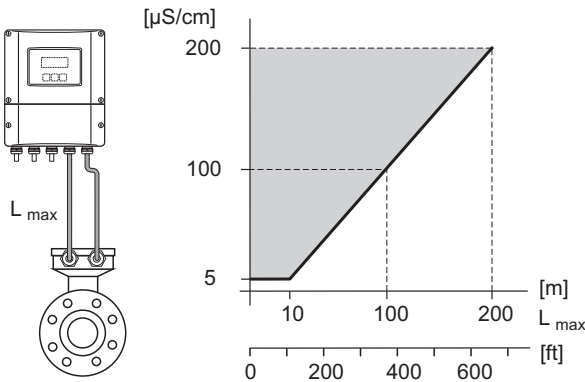

Gray shaded area = permissible range

L_{max} = length of connecting cable in [m]/[ft]

Fluid conductivity in ($\mu\text{S/cm}$)

A0008164

2.3 Installing the Promag E sensor

☝ Caution!

- The plates mounted on the two sensor flanges protect the PTFE which is turned over the flanges and, consequently, should not be removed until immediately prior to mounting the sensor.
- The protective plates must always remain mounted while the device is in storage.
- Make sure that the lining at the flange is not damaged or removed.

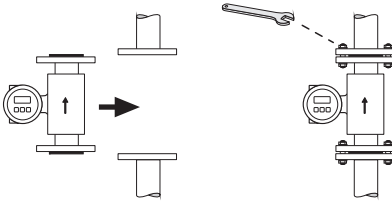

a0008165

Note! Screws, nuts, seals, etc. are not included in the scope of supply and must be supplied by the customer.

The sensor is installed between the two pipe flanges:

- The requisite torques must be observed → 13
- If grounding disks are used, follow the mounting instructions which will be enclosed with the shipment.

2.3.1 Seals

Comply with the following instructions when installing seals:

- **No** seals are required for PFA or PFTE measuring tube lining.
- For DIN flanges, only use seals to DIN EN 1514-1.
- Make sure that the mounted seals do not protrude into the piping cross-section.

☝ Caution!

Risk of short circuit! Do not use electrically conductive sealing compounds such as graphite! An electrically conductive layer could form on the inside of the measuring tube and short-circuit the measuring signal.

2.3.2 Ground cable

If necessary, special ground cables can be ordered as accessories for potential equalization.

2.3.3 Tightening torques for threaded fasteners (Promag E)

Please note the following:

- The tightening torques listed below are for lubricated threads only.
- Always tighten the screws uniformly and in diagonally opposite sequence.
- Overtightening the screws will deform the sealing faces or damage the seals.
- The tightening torques listed below apply only to pipes not subjected to tensile stress.

Promag E screw tightening torques for EN 1092-1 (DIN 2501), PN 6/10/16/40

Nominal diameter [mm]	EN (DIN) Pressure rating [bar]	Threaded fasteners	Flange thickness [mm]	Max. tightening torque [Nm]
15	PN 40	4 × M 12	16	11
25	PN 40	4 × M 12	18	26
32	PN 40	4 × M 16	18	41
40	PN 40	4 × M 16	18	52
50	PN 40	4 × M 16	20	65
65 *	PN 16	8 × M 16	18	43
80	PN 16	8 × M 16	20	53
100	PN 16	8 × M 16	20	57
125	PN 16	8 × M 16	22	75
150	PN 16	8 × M 20	22	99
200	PN 10	8 × M 20	24	141
200	PN 16	12 × M 20	24	94
250	PN 10	12 × M 20	26	110
250	PN 16	12 × M 24	26	131
300	PN 10	12 × M 20	26	125
300	PN 16	12 × M 24	28	179
350	PN 6	12 × M 20	22	200
350	PN 10	16 × M 20	26	188
350	PN 16	16 × M 24	30	254
400	PN 6	16 × M 20	22	166
400	PN 10	16 × M 24	26	260
400	PN 16	16 × M 27	32	330
450	PN 6	16 × M 20	22	202
450	PN 10	20 × M 24	28	235
450	PN 16	20 × M 27	40	300
500	PN 6	20 × M 20	24	176
500	PN 10	20 × M 24	28	265
500	PN 16	20 × M 30	34	448
600	PN 6	20 × M 24	30	242
600	PN 10	20 × M 27	28	345
600 *	PN 16	20 × M 33	36	658
* Designed acc. to EN 1092-1 (not to DIN 2501)				

**Promag E screw tightening torques for EN 1092-1, PN 6/10/16, P245GH/stainless-steel;
Calculated according to EN 1591-1:2014 for flanges according to EN 1092-1:2013**

Nominal diameter [mm]	EN(DIN) Pressure rating	Threaded fasteners	Flange thickness [mm]	Nom. tightening torque PTFE [Nm]
350	PN 10	16 × M 20	26	60
350	PN 16	16 × M 24	30	115
400	PN 10	16 × M 24	26	90
400	PN 16	16 × M 27	32	155
450	PN 10	20 × M 24	28	90
450	PN 16	20 × M 27	34	155
500	PN 10	20 × M 24	28	100
500	PN 16	20 × M 30	36	205
600	PN 10	20 × M 27	30	150
600	PN 16	20 × M 33	40	310

Promag E screw tightening torques for ASME B16.5, Class 150

Nominal diameter		ASME	Threaded fasteners	Max. tightening torque PTFE	
[mm]	[inch]	Pressure rating [lbs]		[Nm]	[lbf · ft]
15	½"	Class 150	4 × ½"	6	4
25	1"	Class 150	4 × ½"	11	8
40	1 ½"	Class 150	4 × ½"	24	18
50	2"	Class 150	4 × 5/8"	47	35
80	3"	Class 150	4 × 5/8"	79	58
100	4"	Class 150	8 × 5/8"	56	41
150	6"	Class 150	8 × ¾"	106	78
200	8"	Class 150	8 × ¾"	143	105
250	10"	Class 150	12 × 7/8"	135	100
300	12"	Class 150	12 × 7/8"	178	131
350	14"	Class 150	12 × 1"	260	192
400	16"	Class 150	16 × 1"	246	181
450	18"	Class 150	16 × 1 ⅛"	371	274
500	20"	Class 150	20 × 1 ⅛"	341	252
600	24"	Class 150	20 × 1 ¼"	477	352

Promag E screw tightening torques for JIS B2220, 10/20K

Nominal diameter [mm]	JIS Pressure rating	Threaded fasteners	Max. tightening torque [Nm] PTFE
15	20K	4 × M 16	16
25	20K	4 × M 16	32
32	20K	4 × M 16	38

Nominal diameter [mm]	JIS	Threaded fasteners	Max. tightening torque [Nm]
	Pressure rating		PTFE
40	20K	4 × M 16	41
50	10K	4 × M 16	54
65	10K	4 × M 16	74
80	10K	8 × M 16	38
100	10K	8 × M 16	47
125	10K	8 × M 20	80
150	10K	8 × M 20	99
200	10K	12 × M 20	82
250	10K	12 × M 22	133
300	10K	16 × M 22	99

2.4 Installing the Promag H sensor

Depending on the order specifications, the sensor is supplied with or without ready-mounted process connections. Mounted process connections are fixed to the sensor with 4 or 6 hexagonal-headed bolts.

 Caution!

Depending on the application and length of the pipe, the sensor may have to be supported or additionally secured. The sensor must be secured if using plastic process connections. An appropriate wall mounting kit can be ordered separately from Endress+Hauser as an accessory.

2.4.1 Seals

When mounting the process connections, make sure that the seals in question are free from dirt and centered correctly.

 Caution!

- The screws must be securely tightened in the case of metal process connections. Together with the sensor, the process connection forms a metal connection that ensures defined seal compression.
- With regard to process connections made of plastic material, comply with the max. torques for lubricated threads (7 Nm / 5.2 lbf ft). A seal must always be used between the connection and counterflange for plastic flanges.
- The seals should be replaced periodically depending on the application, particularly if molded seals are used (aseptic version)! The intervals between seal replacement depend on the frequency of the cleaning cycles and the fluid and cleaning temperatures. Replacement seals can be ordered as an accessory.

2.4.2 Using and mounting grounding rings (DN 2 to 25 / 1/12 to 1")

In the case of process connections made of plastic (e.g. flange connections or adhesive couplings), potential equalization between the sensor and fluid must be ensured via additional grounding rings.

If grounding rings are missing, this can affect accuracy or result in the destruction of the sensor due to electrochemical electrode reduction.

 Caution!

- Depending on the order option, appropriate plastic disks are used instead of grounding rings for the process connections. These plastic disks only act as a kind of "place holder" and do not have any potential equalization function whatsoever. In addition, they also assume an important sealing function at the sensor/connection interface. Thus, these plastic disks/seals should never be removed and should always be mounted for process connections without metal grounding rings!
- Grounding rings can be ordered separately from Endress+Hauser as an accessory. When ordering, make sure that the grounding rings are compatible with the electrode material. Otherwise there is the risk that electrodes can be damaged by electrochemical corrosion! For information on materials, see the Operating Instructions on the CD-ROM.

- Grounding rings, incl. seals, are mounted inside the process connections.
The face-to-face length is not affected.

Installing the grounding rings

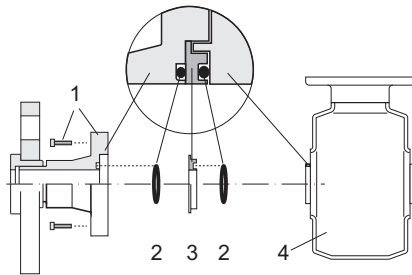

a0008168

- 1 = Process connection hexagonal-headed bolts
- 2 = O-ring seals
- 4 = Sensor
- 3 = Grounding ring or plastic disk (place holder)

- a. Release the 4 or 6 hexagonal-headed bolts (1) and remove the process connection from the sensor (4).
- b. Remove the plastic disk (3) including the two O-ring seals (2) from the process connection.
- c. Insert one of the O-ring seals (2) back into the groove of the process connection.
- d. Place the metal grounding ring (3) into the process connection as illustrated.
- e. Now insert the second O-ring seal (2) into the groove of the grounding ring.
- f. Mount the process connection back onto the sensor. In doing so, make sure to observe the max. torques for lubricated threads (7 Nm) (5.2 lbf ft).

2.4.3 Welding the sensor into the pipe (weld nipples)

 Caution!

Risk of destroying the electronics! Make sure that the welding system is not grounded via the sensor or transmitter.

- a. Secure the sensor with a few welding points in the pipe.
A welding jig suitable for this purpose can be ordered separately as an accessory.
- b. Release the screws on the process connection flange and remove the sensor, including the seal, from the pipe.
- c. Weld the process connection into the pipe.
- d. Mount the sensor back into the pipe.
In doing so, make sure the seals are clean and correctly positioned.

Note! ■ When welding is performed correctly with thin-walled pipes carrying food, the seal is not damaged by the heat even when it is mounted. It is recommended, however, to disassemble the sensor and seal.

- For the disassembly work, it must be possible to open the pipe approx. 8 mm (0.31 in) in total.

2.5 Installing the Promag L sensor

☝ Caution!

- The protective covers mounted on the two sensor flanges (DN 25 to 300 / 1 to 12") are used to hold the lap joint flanges in place and to protect the PTFE liner during transportation. Consequently, do not remove these covers until immediately before the sensor is installed in the pipe.
- The protective plates must always remain mounted while the device is in storage.
- Make sure that the lining at the flange is not damaged or removed.

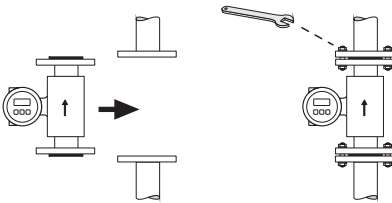

a0008165

Note! Screws, nuts, seals, etc. are not included in the scope of supply and must be supplied by the customer.

The sensor is installed between the two pipe flanges:

- The requisite torques must be observed → 20
- If grounding disks are used, follow the mounting instructions which will be enclosed with the shipment.
- To comply with the device specification, a concentric installation in the measuring section is required

2.5.1 Seals

Comply with the following instructions when installing seals:

- Hard rubber lining → additional seals are **always** required!
- Polyurethane lining → **no** seals are required.
- **No** seals are required for PFTE measuring tube lining.
- For DIN flanges, only use seals to DIN EN 1514-1.
- Make sure that the mounted seals do not protrude into the piping cross-section.

☝ Caution!

Risk of short circuit!

Do not use electrically conductive sealing compounds such as graphite! An electrically conductive layer could form on the inside of the measuring tube and short-circuit the measuring signal.

2.5.2 Ground cable

If necessary, special ground cables can be ordered as accessories for potential equalization.

2.5.3 Screw tightening torques (Promag L)

Please note the following:

- The tightening torques listed below are for lubricated threads only.
- Always tighten the screws uniformly and in diagonally opposite sequence.
- Overtightening the screws will deform the sealing faces or damage the seals.
- The tightening torques listed below apply only to pipes not subjected to tensile stress.

Promag L screw tightening torques for EN 1092-1 (DIN 2501), PN 6/10/16

Nominal diameter [mm]	EN (DIN) Pressure rating	Threaded fasteners	Flange thickness [mm]	Max. tightening torques		
				Hard rubber [Nm]	Polyurethane [Nm]	PTFE [Nm]
25	PN 10/16	4 × M 12	18	-	6	11
32	PN 10/16	4 × M 16	18	-	16	27
40	PN 10/16	4 × M 16	18	-	16	29
50	PN 10/16	4 × M 16	18	-	15	40
65*	PN 10/16	8 × M 16	18	-	10	22
80	PN 10/16	8 × M 16	20	-	15	30
100	PN 10/16	8 × M 16	20	-	20	42
125	PN 10/16	8 × M 16	22	-	30	55
150	PN 10/16	8 × M 20	22	-	50	90
200	PN 16	12 × M 20	24	-	65	87
250	PN 16	12 × M 24	26	-	126	151
300	PN 16	12 × M 24	28	-	139	177
350	PN 6	12 × M 20	22	111	120	-
350	PN 10	16 × M 20	26	112	118	-
350	PN 16	16 × M 24	30	152	165	-
400	PN 6	16 × M 20	22	90	98	-
400	PN 10	16 × M 24	26	151	167	-
400	PN 16	16 × M 27	32	193	215	-
450	PN 6	16 × M 20	22	112	126	-
450	PN 10	20 × M 24	28	153	133	-
500	PN 6	20 × M 20	24	119	123	-
500	PN 10	20 × M 24	28	155	171	-
500	PN 16	20 × M 30	34	275	300	-
600	PN 6	20 × M 24	30	139	147	-
600	PN 10	20 × M 27	28	206	219	-
600*	PN 16	20 × M 33	36	415	443	-
700	PN 6	24 × M 24	24	148	139	-
700	PN 10	24 × M 27	30	246	246	-
700	PN 16	24 × M 33	36	278	318	-
800	PN 6	24 × M 27	24	206	182	-
800	PN 10	24 × M 30	32	331	316	-
800	PN 16	24 × M 36	38	369	385	-

Nominal diameter [mm]	EN (DIN) Pressure rating	Threaded fasteners	Flange thickness [mm]	Max. tightening torques		
				Hard rubber [Nm]	Polyurethane [Nm]	PTFE [Nm]
900	PN 6	24 × M 27	26	230	637	-
900	PN 10	28 × M 30	34	316	307	-
900	PN 16	28 × M 36	40	353	398	-
1000	PN 6	28 × M 27	26	218	208	-
1000	PN 10	28 × M 33	34	402	405	-
1000	PN 16	28 × M 39	42	502	518	-
1200	PN 6	32 × M 30	28	319	299	-
1200	PN 10	32 × M 36	38	564	568	-
1200	PN 16	32 × M 45	48	701	753	-
1400	PN 6	36 × M 33	32	430	-	-
1400	PN 10	36 × M 39	42	654	-	-
1400	PN 16	36 × M 45	52	729	-	-
1600	PN 6	40 × M 33	34	440	-	-
1600	PN 10	40 × M 45	46	946	-	-
1600	PN 16	40 × M 52	58	1007	-	-
1800	PN 6	44 × M 36	36	547	-	-
1800	PN 10	44 × M 45	50	961	-	-
1800	PN 16	44 × M 52	62	1108	-	-
2000	PN 6	48 × M 39	38	629	-	-
2000	PN 10	48 × M 45	54	1047	-	-
2000	PN 16	48 × M 56	66	1324	-	-
2200	PN 6	52 × M 39	42	698	-	-
2200	PN 10	52 × M 52	58	1217	-	-
2400	PN 6	56 × M 39	44	768	-	-
2400	PN 10	56 × M 52	62	1229	-	-

* Designed acc. to EN 1092-1 (not to DIN 2501)

**Promag L screw tightening torques for EN 1092-1, PN 6/10/16, P245GH/stainless-steel;
Calculated according to EN 1591-1:2014 for flange according to EN 1092-1:2013**

Nominal diameter [mm]	EN(DIN) pressure rating	Threaded fastener	Flange thickness [mm]	Nom. tightening torques	
				Hard rubber [Nm]	Polyurethane [Nm]
350	PN 6	12 × M 20	22	60	75
350	PN 10	16 × M 20	26	70	80
400	PN 6	16 × M 20	22	65	70
400	PN 10	16 × M 24	26	100	120
400	PN 16	16 × M 27	32	175	190
450	PN 6	16 × M 20	22	70	90
450	PN 10	20 × M 24	28	100	110
500	PN 6	20 × M 20	24	65	70

Nominal diameter [mm]	EN(DIN) pressure rating	Threaded fastener	Flange thickness [mm]	Nom. tightening torques	
				Hard rubber [Nm]	Polyurethane [Nm]
500	PN 10	20 × M 24	28	110	120
500	PN 16	20 × M 30	36	225	235
600	PN 6	20 × M 24	30	105	105
600	PN 10	20 × M 27	30	165	160
600	PN 16	20 × M 33	40	340	340
700	PN 6	24 × M 24	30	110	110
700	PN 10	24 × M 27	35	190	190
700	PN 16	24 × M 33	40	340	340
800	PN 6	24 × M 27	30	145	145
800	PN 10	24 × M 30	38	260	260
800	PN 16	24 × M 36	41	465	455
900	PN 6	24 × M 27	34	170	180
900	PN 10	28 × M 30	38	265	275
900	PN 16	28 × M 36	48	475	475
1000	PN 6	28 × M 27	38	175	185
1000	PN 10	28 × M 33	44	350	360
1000	PN 16	28 × M 39	59	630	620
1200	PN 6	32 × M 30	42	235	250
1200	PN 10	32 × M 36	55	470	480
1200	PN 16	32 × M 45	78	890	900
1400	PN 6	36 × M 33	56	300	-
1400	PN 10	36 × M 39	65	600	-
1400	PN 16	36 × M 45	84	1050	-
1600	PN 6	40 × M 33	63	340	-
1600	PN 10	40 × M 45	75	810	-
1600	PN 16	40 × M 52	102	1420	-
1800	PN 6	44 × M 36	69	430	-
1800	PN 10	44 × M 45	85	920	-
1800	PN 16	44 × M 52	110	1600	-
2000	PN 6	48 × M 39	74	530	-
2000	PN 10	48 × M 45	90	1040	-
2000	PN 16	48 × M 56	124	1900	-
2200	PN 6	52 × M 39	81	580	-
2200	PN 10	52 × M 52	100	1290	-
2400	PN 6	56 × M 39	87	650	-
2400	PN 10	56 × M 52	110	1410	-

Promag L screw tightening torques for ASME B16.5, Class 150

Nominal diameter		ASME Pressure rating [lbs]	Threaded fasteners	Max. tightening torque					
[mm]	[inch]			Hard rubber		Polyurethane		PTFE	
				[Nm]	[lbf · ft]	[Nm]	[lbf · ft]	[Nm]	[lbf · ft]
25	1	Class 150	4 × 5/8"	-	-	5	4	14	13
40	1 ½	Class 150	4 × 5/8"	-	-	10	7	21	15
50	2"	Class 150	4 × 5/8"	-	-	15	11	40	29
80	3"	Class 150	4 × 5/8"	-	-	25	18	65	48
100	4"	Class 150	8 × 5/8"	-	-	20	15	44	32
150	6"	Class 150	8 × ¾"	-	-	45	33	90	66
200	8"	Class 150	8 × ¾"	-	-	65	48	87	64
250	10"	Class 150	12 × 7/8"	-	-	126	93	151	112
300	12"	Class 150	12 × 7/8"	-	-	146	108	177	131
350	14"	Class 150	12 × 1"	135	100	158	117	-	-
400	16"	Class 150	16 × 1"	128	94	150	111	-	-
450	18"	Class 150	16 × 1 ½"	204	150	234	173	-	-
500	20"	Class 150	20 × 1 ½"	183	135	217	160	-	-
600	24"	Class 150	20 × 1 ¼"	268	198	307	226	-	-

Promag L screw tightening torques for AWWA, Class D

Nominal diameter		AWWA Pressure rating	Threaded fasteners	Max. tightening torque					
[mm]	[inch]			Hard rubber		Polyurethane		PTFE	
				[Nm]	[lbf · ft]	[Nm]	[lbf · ft]	[Nm]	[lbf · ft]
700	28"	Class D	28 × 1 ¼"	247	182	292	215	-	-
750	30"	Class D	28 × 1 ¼"	287	212	302	223	-	-
800	32"	Class D	28 × 1 ½"	394	291	422	311	-	-
900	36"	Class D	32 × 1 ½"	419	309	430	317	-	-
1000	40"	Class D	36 × 1 ½"	420	310	477	352	-	-
1050	42"	Class D	36 × 1 ½"	528	389	518	382	-	-
1200	48"	Class D	44 × 1 ½"	552	407	531	392	-	-
1350	54"	Class D	44 × 1 ¾"	730	538	-	-	-	-
1500	60"	Class D	52 × 1 ¾"	758	559	-	-	-	-
1650	66"	Class D	52 × 1 ¾"	946	698	-	-	-	-
1800	72"	Class D	60 × 1 ¾"	975	719	-	-	-	-
2000	78"	Class D	64 × 2"	853	629	-	-	-	-
2150	84"	Class D	64 × 2"	931	687	-	-	-	-
2300	90"	Class D	68 × 2 ¼"	1048	773	-	-	-	-

Promag L screw tightening torques for AS 2129, Table E

Nominal diameter [mm]	AS 2129 Pressure rating	Threaded fasteners	Max. tightening torque		
			Hard rubber [Nm]	Polyurethane [Nm]	PTFE [Nm]
350	Table E	12 × M 24	203	-	-
400	Table E	12 × M 24	226	-	-
450	Table E	16 × M 24	226	-	-
500	Table E	16 × M 24	271	-	-
600	Table E	16 × M 30	439	-	-
700	Table E	20 × M 30	355	-	-
750	Table E	20 × M 30	559	-	-
800	Table E	20 × M 30	631	-	-
900	Table E	24 × M 30	627	-	-
1000	Table E	24 × M 30	634	-	-
1200	Table E	32 × M 30	727	-	-

Promag L screw tightening torques for AS 4087, PN16

Nominal diameter [mm]	AS 4087 Pressure rating	Threaded fasteners	Max. tightening torque		
			Hard rubber [Nm]	Polyurethane [Nm]	PTFE [Nm]
350	PN 16	12 × M 24	203	-	-
375	PN 16	12 × M 24	137	-	-
400	PN 16	12 × M 24	226	-	-
450	PN 16	12 × M 24	301	-	-
500	PN 16	16 × M 24	271	-	-
600	PN 16	16 × M 27	393	-	-
700	PN 16	20 × M 27	330	-	-
750	PN 16	20 × M 30	529	-	-
800	PN 16	20 × M 33	631	-	-
900	PN 16	24 × M 33	627	-	-
1000	PN 16	24 × M 33	595	-	-
1200	PN 16	32 × M 33	703	-	-

2.6 Installing the Promag P sensor

☝ Caution!

- The plates mounted on the two sensor flanges protect the PTFE which is turned over the flanges and, consequently, should not be removed until immediately prior to mounting the sensor.
- The protective plates must always remain mounted while the device is in storage.
- Make sure that the lining at the flange is not damaged or removed.

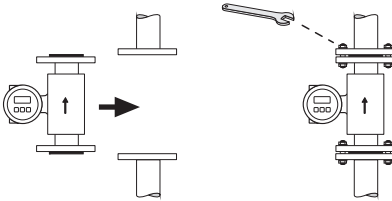

a0008165

Note! Screws, nuts, seals, etc. are not included in the scope of supply and must be supplied by the customer.

The sensor is installed between the two pipe flanges:

- The requisite torques must be observed → 26
- If grounding disks are used, follow the mounting instructions which will be enclosed with the shipment.

2.6.1 Seals

Comply with the following instructions when installing seals:

- **No** seals are required for PFA or PFTE measuring tube lining.
- For DIN flanges, only use seals to DIN EN 1514-1.
- Make sure that the mounted seals do not protrude into the piping cross-section.

☝ Caution!

Risk of short circuit! Do not use electrically conductive sealing compounds such as graphite! An electrically conductive layer could form on the inside of the measuring tube and short-circuit the measuring signal.

2.6.2 Ground cable

If necessary, special ground cables can be ordered as accessories for potential equalization.

2.6.3 Installing the high-temperature version (with PFA lining)

The high-temperature version has a housing support for the thermal separation of sensor and transmitter. The high-temperature version is always used for applications in which high ambient temperatures are encountered **in conjunction with** high fluid temperatures. The high-temperature version is obligatory if the fluid temperature exceeds +150 °C.

Note! You will find information on permissible temperature ranges in the Operating Instructions of the CD-ROM

Insulation

Pipes generally have to be insulated if they carry very hot fluids, in order to avoid energy losses and to prevent accidental contact with pipes at temperatures that could cause injury. Guidelines regulating the insulation of pipes have to be taken into account.

 Caution!

Risk of measuring electronics overheating. The housing support dissipates heat and its entire surface area must remain uncovered. Make sure that the sensor insulation does not extend past the top of the two sensor shells.

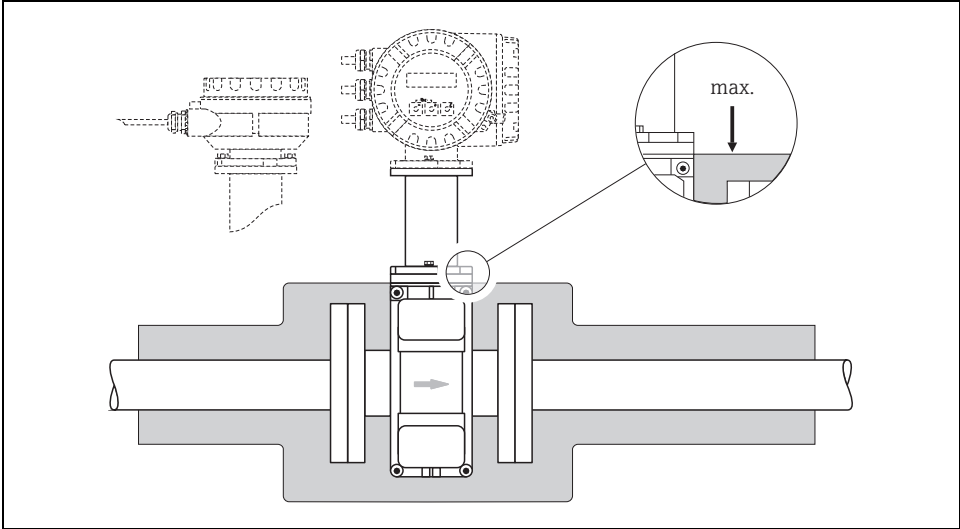

A0004300

2.6.4 Tightening torques for threaded fasteners (Promag P)

Please note the following:

- The tightening torques listed below are for lubricated threads only.
- Always tighten the screws uniformly and in diagonally opposite sequence.
- Overtightening the screws will deform the sealing faces or damage the seals.
- The tightening torques listed below apply only to pipes not subjected to tensile stress.

Promag P screw tightening torques for EN 1092-1 (DIN 2501), PN 10/16/25/40

Nominal diameter [mm]	EN (DIN) Pressure rating [bar]	Threaded fasteners	Flange thickness [mm]	Max. tightening torque [Nm]	
				PTFE	PFA
15	PN 40	4 × M 12	16	11	–
25	PN 40	4 × M 12	18	26	20
32	PN 40	4 × M 16	18	41	35
40	PN 40	4 × M 16	18	52	47
50	PN 40	4 × M 16	20	65	59
65 *	PN 16	8 × M 16	18	43	40
65	PN 40	8 × M 16	22	43	40
80	PN 16	8 × M 16	20	53	48
80	PN 40	8 × M 16	24	53	48
100	PN 16	8 × M 16	20	57	51
100	PN 40	8 × M 20	24	78	70
125	PN 16	8 × M 16	22	75	67
125	PN 40	8 × M 24	26	111	99
150	PN 16	8 × M 20	22	99	85
150	PN 40	8 × M 24	28	136	120
200	PN 10	8 × M 20	24	141	101
200	PN 16	12 × M 20	24	94	67
200	PN 25	12 × M 24	30	138	105
250	PN 10	12 × M 20	26	110	–
250	PN 16	12 × M 24	26	131	–
250	PN 25	12 × M 27	32	200	–
300	PN 10	12 × M 20	26	125	–
300	PN 16	12 × M 24	28	179	–
300	PN 25	16 × M 27	34	204	–
350	PN 10	16 × M 20	26	188	–
350	PN 16	16 × M 24	30	254	–
350	PN 25	16 × M 30	38	380	–
400	PN 10	16 × M 24	26	260	–
400	PN 16	16 × M 27	32	330	–
400	PN 25	16 × M 33	40	488	–
450	PN 10	20 × M 24	28	235	–
450	PN 16	20 × M 27	40	300	–
450	PN 25	20 × M 33	46	385	–
500	PN 10	20 × M 24	28	265	–
500	PN 16	20 × M 30	34	448	–
500	PN 25	20 × M 33	48	533	–
600	PN 10	20 × M 27	28	345	–
600 *	PN 16	20 × M 33	36	658	–
600	PN 25	20 × M 36	58	731	–

* Designed acc. to EN 1092-1 (not to DIN 2501)

**Promag P screw tightening torques for EN 1092-1, PN 10/16/25, P245GH/stainless-steel;
Calculated according to EN 1591-1:2014 for flange according to EN 1092-1:2013**

Nominal diameter [mm]	EN (DIN) pressure rating	Threaded fasteners	Flange thickness [mm]	Nom. tightening torques PTFE [Nm]
350	PN 10	16 × M 20	26	60
350	PN 16	16 × M 24	30	115
350	PN 25	16 × M 30	38	220
400	PN 10	16 × M 24	26	90
400	PN 16	16 × M 27	32	155
400	PN 25	16 × M 33	40	290
450	PN 10	20 × M 24	28	90
450	PN 16	20 × M 27	34	155
450	PN 25	20 × M 33	46	290
500	PN 10	20 × M 24	28	100
500	PN 16	20 × M 30	36	205
500	PN 25	20 × M 33	48	345
600	PN 10	20 × M 27	30	150
600	PN 16	20 × M 33	40	310
600	PN 25	20 × M 36	48	500

Promag P screw tightening torques for ASME B16.5, Class 150/300

Nominal diameter		ASME Pressure rating [lbs]	Threaded fasteners	Max. tightening torque			
[mm]	[inch]			PTFE		PFA	
			[Nm]	[lbf · ft]	[Nm]	[lbf · ft]	
15	½"	Class 150	4 × ½"	6	4	-	-
15	½"	Class 300	4 × ½"	6	4	-	-
25	1"	Class 150	4 × ½"	11	8	10	7
25	1"	Class 300	4 × 5/8"	14	10	12	9
40	1 ½"	Class 150	4 × ½"	24	18	21	15
40	1 ½"	Class 300	4 × ¾"	34	25	31	23
50	2"	Class 150	4 × 5/8"	47	35	44	32
50	2"	Class 300	8 × 5/8"	23	17	22	16
80	3"	Class 150	4 × 5/8"	79	58	67	49
80	3"	Class 300	8 × ¾"	47	35	42	31
100	4"	Class 150	8 × 5/8"	56	41	50	37
100	4"	Class 300	8 × ¾"	67	49	59	44
150	6"	Class 150	8 × ¾"	106	78	86	63
150	6"	Class 300	12 × ¾"	73	54	67	49
200	8"	Class 150	8 × ¾"	143	105	109	80
250	10"	Class 150	12 × 7/8"	135	100	-	-
300	12"	Class 150	12 × 7/8"	178	131	-	-

Nominal diameter		ASME Pressure rating [lbs]	Threaded fasteners	Max. tightening torque			
[mm]	[inch]			PTFE		PFA	
				[Nm]	[lbf · ft]	[Nm]	[lbf · ft]
350	14"	Class 150	12 × 1"	260	192	-	-
400	16"	Class 150	16 × 1"	246	181	-	-
450	18"	Class 150	16 × 1 1/8"	371	274	-	-
500	20"	Class 150	20 × 1 1/8"	341	252	-	-
600	24"	Class 150	20 × 1 1/4"	477	352	-	-

Promag P screw tightening torques for JIS B2220, 10/20K

Nominal diameter [mm]	JIS Pressure rating	Threaded fasteners	Max. tightening torque [Nm]	
			PTFE	PFA
25	10K	4 × M 16	32	27
25	20K	4 × M 16	32	27
32	10K	4 × M 16	38	-
32	20K	4 × M 16	38	-
40	10K	4 × M 16	41	37
40	20K	4 × M 16	41	37
50	10K	4 × M 16	54	46
50	20K	8 × M 16	27	23
65	10K	4 × M 16	74	63
65	20K	8 × M 16	37	31
80	10K	8 × M 16	38	32
80	20K	8 × M 20	57	46
100	10K	8 × M 16	47	38
100	20K	8 × M 20	75	58
125	10K	8 × M 20	80	66
125	20K	8 × M 22	121	103
150	10K	8 × M 20	99	81
150	20K	12 × M 22	108	72
200	10K	12 × M 20	82	54
200	20K	12 × M 22	121	88
250	10K	12 × M 22	133	-
250	20K	12 × M 24	212	-
300	10K	16 × M 22	99	-
300	20K	16 × M 24	183	-

Promag P tightening torques for JIS B2220, 10/20K

Nominal diameter [mm]	JIS Pressure rating	Threaded fasteners	Nom. tightening torques	
			Hard rubber [Nm]	Polyurethane [Nm]
350	10K	16 × M 22	109	109
350	20K	16 × M 30 x3	217	217
400	10K	16 × M 24	163	163
400	20K	16 × M 30x3	258	258
450	10K	16 × M 24	155	155
450	20K	16 × M 30x3	272	272
500	10K	16 × M 24	183	183
500	20K	16 × M 30x3	315	315
600	10K	16 × M 30	235	235
600	20K	16 × M 36x3	381	381

Promag P screw tightening torques for AS 2129, Table E

Nominal diameter [mm]	AS 2129 Pressure rating	Threaded fasteners	Max. tightening torque [Nm] PTFE
25	Table E	4 × M 12	21
50	Table E	4 × M 16	42

Promag P screw tightening torques for AS 4087, PN16

Nominal diameter [mm]	AS 4087 Pressure rating	Threaded fasteners	Max. tightening torque [Nm] PTFE
50	PN 16	4 × M 16	42

2.7 Installing the Promag W sensor

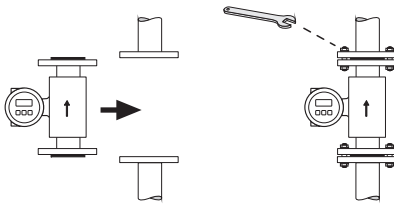

a0008165

Note! Screws, nuts, seals, etc. are not included in the scope of supply and must be supplied by the customer.

The sensor is installed between the two pipe flanges:

- The requisite torques must be observed → 31
- If grounding disks are used, follow the mounting instructions which will be enclosed with the shipment.
- To comply with the device specification, a concentrical installation in the measuring section is required

2.7.1 Seals

Comply with the following instructions when installing seals:

- Hard rubber lining → additional seals are **always** necessary.
- Polyurethane lining → **no** seals are required.
- For DIN flanges, use only seals according to EN 1514-1.
- Make sure that the seals do not protrude into the piping cross-section.



Caution!

Risk of short circuit!

Do not use electrically conductive sealing compounds such as graphite! An electrically conductive layer could form on the inside of the measuring tube and short-circuit the measuring signal.

2.7.2 Ground cable

If necessary, special ground cables can be ordered as accessories for potential equalization.

2.7.3 Screw tightening torques (Promag W)

Please note the following:

- The tightening torques listed below are for lubricated threads only.
- Always tighten the screws uniformly and in diagonally opposite sequence.
- Overtightening the screws will deform the sealing faces or damage the seals.
- The tightening torques listed below apply only to pipes not subjected to tensile stress.

Promag W screw tightening torques for EN 1092-1 (DIN 2501), PN 6/10/16/25/40

Nominal diameter [mm]	EN (DIN) Pressure rating [bar]	Threaded fasteners	Flange thickness [mm]	Max. tightening torque [Nm]	
				Hard rubber	Polyurethane
25	PN 40	4 × M 12	18	-	15
32	PN 40	4 × M 16	18	-	24
40	PN 40	4 × M 16	18	-	31
50	PN 40	4 × M 16	20	48	40
65*	PN 16	8 × M 16	18	32	27
65	PN 40	8 × M 16	22	32	27
80	PN 16	8 × M 16	20	40	34
80	PN 40	8 × M 16	24	40	34
100	PN 16	8 × M 16	20	43	36
100	PN 40	8 × M 20	24	59	50
125	PN 16	8 × M 16	22	56	48
125	PN 40	8 × M 24	26	83	71
150	PN 16	8 × M 20	22	74	63
150	PN 40	8 × M 24	28	104	88
200	PN 10	8 × M 20	24	106	91
200	PN 16	12 × M 20	24	70	61
200	PN 25	12 × M 24	30	104	92
250	PN 10	12 × M 20	26	82	71
250	PN 16	12 × M 24	26	98	85
250	PN 25	12 × M 27	32	150	134
300	PN 10	12 × M 20	26	94	81
300	PN 16	12 × M 24	28	134	118
300	PN 25	16 × M 27	34	153	138
350	PN 6	12 × M 20	22	111	120
350	PN 10	16 × M 20	26	112	118
350	PN 16	16 × M 24	30	152	165
350	PN 25	16 × M 30	38	227	252
400	PN 6	16 × M 20	22	90	98
400	PN 10	16 × M 24	26	151	167
400	PN 16	16 × M 27	32	193	215
400	PN 25	16 × M 33	40	289	326
450	PN 6	16 × M 20	22	112	126
450	PN 10	20 × M 24	28	153	133
450	PN 16	20 × M 27	40	198	196
450	PN 25	20 × M 33	46	256	253
500	PN 6	20 × M 20	24	119	123
500	PN 10	20 × M 24	28	155	171
500	PN 16	20 × M 30	34	275	300
500	PN 25	20 × M 33	48	317	360
600	PN 6	20 × M 24	30	139	147

Nominal diameter [mm]	EN (DIN)		Threaded fasteners	Flange thickness [mm]	Max. tightening torque [Nm]	
	Pressure rating [bar]				Hard rubber	Polyurethane
600		PN 10	20 × M 27	28	206	219
600 *		PN 16	20 × M 33	36	415	443
600		PN 25	20 × M 36	58	431	516
700		PN 6	24 × M 24	24	148	139
700		PN 10	24 × M 27	30	246	246
700		PN 16	24 × M 33	36	278	318
700		PN 25	24 × M 39	46	449	507
800		PN 6	24 × M 27	24	206	182
800		PN 10	24 × M 30	32	331	316
800		PN 16	24 × M 36	38	369	385
800		PN 25	24 × M 45	50	664	721
900		PN 6	24 × M 27	26	230	637
900		PN 10	28 × M 30	34	316	307
900		PN 16	28 × M 36	40	353	398
900		PN 25	28 × M 45	54	690	716
1000		PN 6	28 × M 27	26	218	208
1000		PN 10	28 × M 33	34	402	405
1000		PN 16	28 × M 39	42	502	518
1000		PN 25	28 × M 52	58	970	971
1200		PN 6	32 × M 30	28	319	299
1200		PN 10	32 × M 36	38	564	568
1200		PN 16	32 × M 45	48	701	753
1400		PN 6	36 × M 33	32	430	398
1400		PN 10	36 × M 39	42	654	618
1400		PN 16	36 × M 45	52	729	762
1600		PN 6	40 × M 33	34	440	417
1600		PN 10	40 × M 45	46	946	893
1600		PN 16	40 × M 52	58	1007	1100
1800		PN 6	44 × M 36	36	547	521
1800		PN 10	44 × M 45	50	961	895
1800		PN 16	44 × M 52	62	1108	1003
2000		PN 6	48 × M 39	38	629	605
2000		PN 10	48 × M 45	54	1047	1092
2000		PN 16	48 × M 56	66	1324	1261
* Designed acc. to EN 1092-1 (not to DIN 2501)						

Promag W screw tightening torques for EN 1092-1, PN 6/10/16/25, P245GH/stainless-steel; Calculated according to EN 1591-1:2014 for flange according to EN 1092-1:2013

Nominal diameter [mm]	EN (DIN) pressure rating	Threaded fasteners	flange thickness [mm]	Nom. tightening torque	
				Hard rubber [Nm]	Polyurethane [Nm]
350	PN 6	12 × M 20	22	60	75
350	PN 10	16 × M 20	26	70	80
350	PN 16	16 × M 24	30	125	135
350	PN 25	16 × M 30	38	230	235
400	PN 6	16 × M 20	22	65	70
400	PN 10	16 × M 24	26	100	120
400	PN 16	16 × M 27	32	175	190
400	PN 25	16 × M 33	40	315	325
450	PN 6	16 × M 20	22	70	90
450	PN 10	20 × M 24	28	100	110
450	PN 16	20 × M 27	34	175	190
450	PN 25	20 × M 33	46	300	310
500	PN 6	20 × M 20	24	65	70
500	PN 10	20 × M 24	28	110	120
500	PN 16	20 × M 30	36	225	235
500	PN 25	20 × M 33	48	370	370
600	PN 6	20 × M 24	30	105	105
600	PN 10	20 × M 27	30	165	160
600	PN 16	20 × M 33	40	340	340
600	PN 25	20 × M 36	48	540	540
700	PN 6	24 × M 24	30	110	110
700	PN 10	24 × M 27	35	190	190
700	PN 16	24 × M 33	40	340	340
700	PN 25	24 × M 39	50	615	595
800	PN 6	24 × M 27	30	145	145
800	PN 10	24 × M 30	38	260	260
800	PN 16	24 × M 36	41	465	455
800	PN 25	24 × M 45	53	885	880
900	PN 6	24 × M 27	34	170	180
900	PN 10	28 × M 30	38	265	275
900	PN 16	28 × M 36	48	475	475
900	PN 25	28 × M 45	57	930	915
1000	PN 6	28 × M 27	38	175	185
1000	PN 10	28 × M 33	44	350	360
1000	PN 16	28 × M 39	59	630	620

Nominal diameter [mm]	EN (DIN) pressure rating	Threaded fasteners	flange thickness [mm]	Nom. tightening torque	
				Hard rubber [Nm]	Polyurethane [Nm]
1000	PN 25	28 × M 52	63	1300	1290
1200	PN 6	32 × M 30	42	235	250
1200	PN 10	32 × M 36	55	470	480
1200	PN 16	32 × M 45	78	890	900
1400	PN 6	36 × M 33	56	300	-
1400	PN 10	36 × M 39	65	600	-
1400	PN 16	36 × M 45	84	1050	-
1600	PN 6	40 × M 33	63	340	-
1600	PN 10	40 × M 45	75	810	-
1600	PN 16	40 × M 52	102	1420	-
1800	PN 6	44 × M 36	69	430	-
1800	PN 10	44 × M 45	85	920	-
1800	PN 16	44 × M 52	110	1600	-
2000	PN 6	48 × M 39	74	530	-
2000	PN 10	48 × M 45	90	1040	-
2000	PN 16	48 × M 56	124	1900	-

Promag W screw tightening torques for ASME B16.5, Class 150/300

Nominal diameter		ASME Pressure rating [lbs]	Threaded fasteners	Max. tightening torque			
[mm]	[inch]			Hard rubber [Nm]	Hard rubber [lbf · ft]	Polyurethane [Nm]	Polyurethane [lbf · ft]
25	1"	Class 150	4 × ½"	-	-	7	5
25	1"	Class 300	4 × 5/8"	-	-	8	6
40	1 ½"	Class 150	4 × ½"	-	-	10	7
40	1 ½"	Class 300	4 × ¾"	-	-	15	11
50	2"	Class 150	4 × 5/8"	35	26	22	16
50	2"	Class 300	8 × 5/8"	18	13	11	8
80	3"	Class 150	4 × 5/8"	60	44	43	32
80	3"	Class 300	8 × ¾"	38	28	26	19
100	4"	Class 150	8 × 5/8"	42	31	31	23
100	4"	Class 300	8 × ¾"	58	43	40	30
150	6"	Class 150	8 × ¾"	79	58	59	44
150	6"	Class 300	12 × ¾"	70	52	51	38
200	8"	Class 150	8 × ¾"	107	79	80	59
250	10"	Class 150	12 × 7/8"	101	74	75	55
300	12"	Class 150	12 × 7/8"	133	98	103	76
350	14"	Class 150	12 × 1"	135	100	158	117
400	16"	Class 150	16 × 1"	128	94	150	111

Nominal diameter		ASME Pressure rating [lbs]	Threaded fasteners	Max. tightening torque			
[mm]	[inch]			Hard rubber [Nm]		Polyurethane [Nm]	
450	18"	Class 150	16 × 1 1/8"	204	150	234	173
500	20"	Class 150	20 × 1 1/8"	183	135	217	160
600	24"	Class 150	20 × 1 1/4"	268	198	307	226

Promag W screw tightening torques for JIS B2220, 10/20K

Nominal diameter [mm]	JIS Pressure rating	Threaded fasteners	Max. tightening torque [Nm]	
			Hard rubber	Polyurethane
25	10K	4 × M 16	-	19
25	20K	4 × M 16	-	19
32	10K	4 × M 16	-	22
32	20K	4 × M 16	-	22
40	10K	4 × M 16	-	24
40	20K	4 × M 16	-	24
50	10K	4 × M 16	40	33
50	20K	8 × M 16	20	17
65	10K	4 × M 16	55	45
65	20K	8 × M 16	28	23
80	10K	8 × M 16	29	23
80	20K	8 × M 20	42	35
100	10K	8 × M 16	35	29
100	20K	8 × M 20	56	48
125	10K	8 × M 20	60	51
125	20K	8 × M 22	91	79
150	10K	8 × M 20	75	63
150	20K	12 × M 22	81	72
200	10K	12 × M 20	61	52
200	20K	12 × M 22	91	80
250	10K	12 × M 22	100	87
250	20K	12 × M 24	159	144
300	10K	16 × M 22	74	63
300	20K	16 × M 24	138	124

Promag W screw tightening torques for JIS B2220, 10/20K

Nominal diameter [mm]	JIS Pressure rating	Threaded fasteners	Nom. tightening torque	
			Hard rubber [Nm]	Polyurethane [Nm]
350	10K	16 × M 22	109	109
350	20K	16 × M 30 x3	217	217

Nominal diameter [mm]	JIS Pressure rating	Threaded fasteners	Nom. tightening torque	
			Hard rubber [Nm]	Polyurethane [Nm]
400	10K	16 × M 24	163	163
400	20K	16 × M 30x3	258	258
450	10K	16 × M 24	155	155
450	20K	16 × M 30x3	272	272
500	10K	16 × M 24	183	183
500	20K	16 × M 30x3	315	315
600	10K	16 × M 30	235	235
600	20K	16 × M 36x3	381	381
700	10K	16 × M 30	300	300
750	10K	16 × M 30	339	339

Promag W screw tightening torques for AWWA, Class D

Nominal diameter		AWWA Pressure rating	Threaded fasteners	Max. tightening torque			
[mm]	[inch]			Hard rubber [Nm]	[lbf · ft]	Polyurethane [Nm]	[lbf · ft]
700	28"	Class D	28 × 1 ¼"	247	182	292	215
750	30"	Class D	28 × 1 ¼"	287	212	302	223
800	32"	Class D	28 × 1 ½"	394	291	422	311
900	36"	Class D	32 × 1 ½"	419	309	430	317
1000	40"	Class D	36 × 1 ½"	420	310	477	352
1050	42"	Class D	36 × 1 ½"	528	389	518	382
1200	48"	Class D	44 × 1 ½"	552	407	531	392
1350	54"	Class D	44 × 1 ¾"	730	538	633	467
1500	60"	Class D	52 × 1 ¾"	758	559	832	614
1650	66"	Class D	52 × 1 ¾"	946	698	955	704
1800	72"	Class D	60 × 1 ¾"	975	719	1087	802
2000	78"	Class D	64 × 2"	853	629	786	580

Promag W screw tightening torques for AS 2129, Table E

Nominal diameter [mm]	AS 2129 Pressure rating	Threaded fasteners	Max. tightening torque [Nm] Hard rubber
50	Table E	4 × M 16	32
80	Table E	4 × M 16	49
100	Table E	8 × M 16	38
150	Table E	8 × M 20	64
200	Table E	8 × M 20	96
250	Table E	12 × M 20	98
300	Table E	12 × M 24	123

Nominal diameter [mm]	AS 2129 Pressure rating	Threaded fasteners	Max. tightening torque [Nm] Hard rubber
350	Table E	12 × M 24	203
400	Table E	12 × M 24	226
450	Table E	16 × M 24	226
500	Table E	16 × M 24	271
600	Table E	16 × M 30	439
700	Table E	20 × M 30	355
750	Table E	20 × M 30	559
800	Table E	20 × M 30	631
900	Table E	24 × M 30	627
1000	Table E	24 × M 30	634
1200	Table E	32 × M 30	727

Promag W screw tightening torques for AS 4087, PN16

Nominal diameter [mm]	AS 4087 Pressure rating	Threaded fasteners	Max. tightening torque [Nm] Hard rubber
50	Table E	4 × M 16	32
80	PN 16	4 × M 16	49
100	PN 16	4 × M 16	76
150	PN 16	8 × M 20	52
200	PN 16	8 × M 20	77
250	PN 16	8 × M 20	147
300	PN 16	12 × M 24	103
350	PN 16	12 × M 24	203
375	PN 16	12 × M 24	137
400	PN 16	12 × M 24	226
450	PN 16	12 × M 24	301
500	PN 16	16 × M 24	271
600	PN 16	16 × M 27	393
700	PN 16	20 × M 27	330
750	PN 16	20 × M 30	529
800	PN 16	20 × M 33	631
900	PN 16	24 × M 33	627
1000	PN 16	24 × M 33	595
1200	PN 16	32 × M 33	703

2.8 Installing the transmitter housing

2.8.1 Turning the transmitter housing

Turning the aluminum field housing

Aluminum field housing for non-Ex area

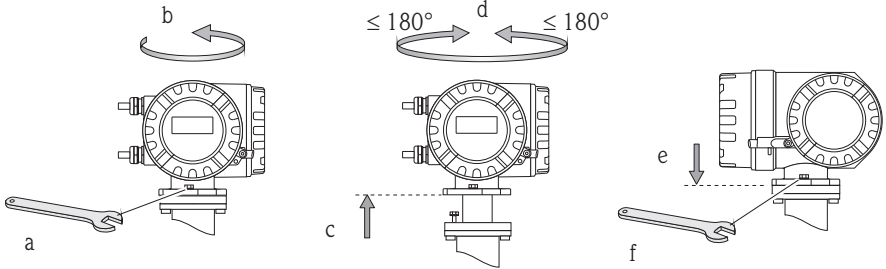

A0007540

Aluminum field housing for Zone 1 or Class I Div. 1

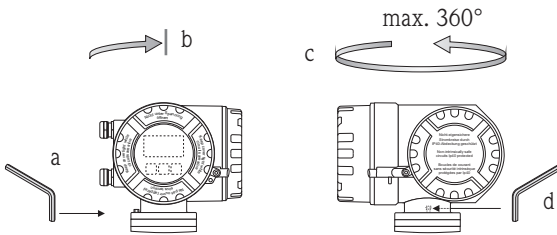

A0008036

For Zone 1 or Class I Div. 1:

- Release the setscrew.
- Turn the transmitter housing gently clockwise until the stop (end of the thread).
- Turn the transmitter counterclockwise (max. 360°) to the desired position.
- Retighten the setscrew.

Turning the stainless steel field housing

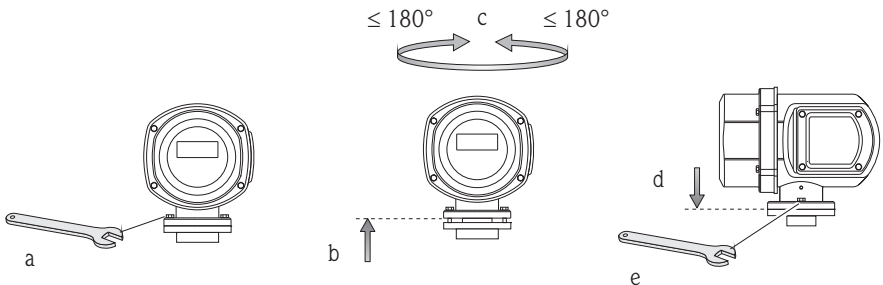

A0007661

2.8.2 Turning the onsite display

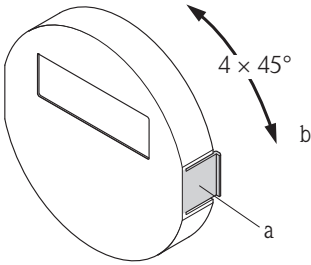

A0007541

- a. Press in the side latches on the display module and remove the module from the cover plate of the electronics compartment.
- b. Turn the display to the desired position (max. $4 \times 45^\circ$ in both directions) and reset it onto the cover plate of the electronics compartment.

2.8.3 Installing the wall-mount housing

 Caution!

- Make sure that the ambient temperature does not exceed the permitted range.
- Always install the wall-mount housing in such a way that the cable entries point downwards.

Mounted directly on the wall

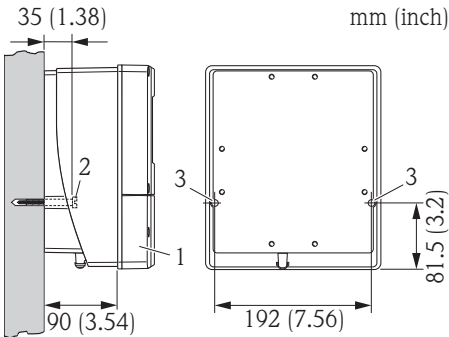

1. Connection compartment
2. Securing screws M6 (max. \varnothing 6.5 mm (0.26")); screw head max. \varnothing 10.5 mm (0.4")
3. Housing bores for securing screws

A0007542

Engineering unit mm (in)

Pipe mounting

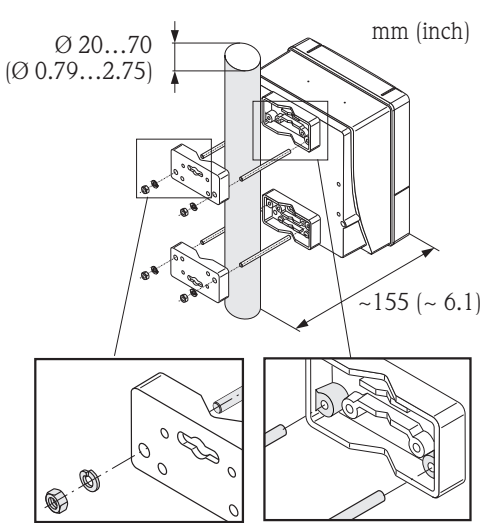

Caution!
 Danger of overheating! If the device is mounted on a warm pipe, make sure that the housing temperature does not exceed $+60\text{ }^{\circ}\text{C}$ ($+140\text{ }^{\circ}\text{F}$) which is the maximum temperature permitted.

Engineering unit mm (in)

A0007543

Panel mounting

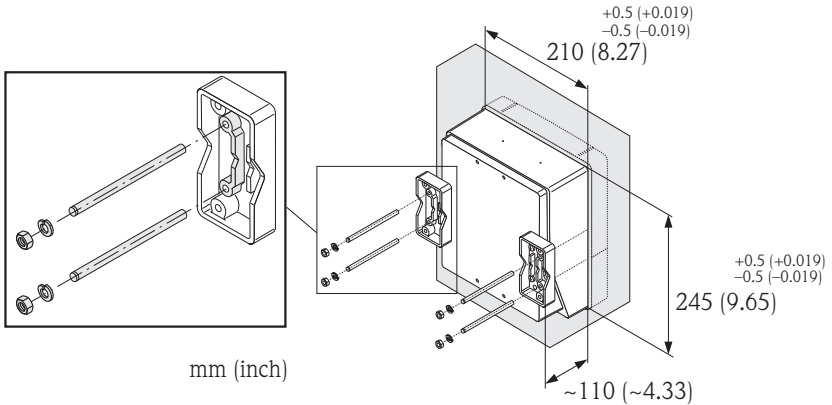

mm (inch)

Engineering unit mm (in)

A0007544

2.9 Post-installation check

- Is the measuring device damaged (visual inspection)?
- Does the device correspond to specifications at the measuring point, including process temperature and pressure, ambient temperature, minimum fluid conductivity, measuring range, etc.?
- Does the arrow on the sensor nameplate match the actual direction of flow through the pipe?
- Is the position of the measuring electrode plane correct?
- Were all screws tightened to the specified torques when the sensor was installed?
- Were the correct seals used (type, material, installation)?
- Are the measuring point number and labeling correct (visual inspection)?
- Were the inlet and outlet runs respected?
 - Inlet run $\geq 5 \times \text{DN}$
 - Outlet run $\geq 2 \times \text{DN}$
- Is the measuring device protected against moisture and direct sunlight?
- Is the sensor adequately protected against vibration (attachment, support)?
Acceleration up to 2 g by analogy with IEC 600 68-2-8.

3 Wiring

Warning!

Risk of electric shock! Components carry dangerous voltages.

- Never mount or wire the measuring device while it is connected to the power supply.
- Before connecting the power supply, check the safety equipment.
- Route the power supply and electrode cables so they are securely seated.
- Seal the cable entries and covers tight.

Caution!

Risk of damaging the electronic components!

- Connect the power supply in accordance with the connection data on the nameplate.
- Connect the electrode cable in accordance with the connection data in the Operating Instructions or the Ex documentation on the CD-ROM.

In addition, for the remote version

Caution!

Risk of damaging the electronic components!

- Only connect sensors and transmitters with the same serial number.
- Observe the cable specifications of the connecting cable → Operating Instructions on the CD-ROM.

Note! Install the connecting cable securely to prevent movement.

In addition, for measuring devices with fieldbus communication

Caution!

Risk of damaging the electronic components!

- Observe the cable specification of the fieldbus cable → Operating Instructions on the CD-ROM.
- Keep the stripped and twisted lengths of cable shield as short as possible.
- Screen and ground the signal lines → Operating Instructions on the CD-ROM.
- When using in systems without potential equalization → Operating Instructions on the CD-ROM.

In addition, for Ex-certified measuring devices

Warning!

When wiring Ex-certified measuring devices, all the safety instructions, wiring diagrams, technical information etc. of the related Ex documentation must be observed

→ Ex documentation on the CD-ROM.

3.1 Connecting the various housing types

Wire the unit using the terminal assignment diagram inside the cover.

3.1.1 Compact version

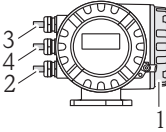

A0007545

Transmitter connection:

- 1 Connection diagram inside the connection compartment cover
- 2 Power supply cable
- 3 Electrode cable or fieldbus cable
- 4 Optional

3.1.2 Remote version (transmitter): non-Ex Zone, Ex Zone 2, Class I Div. 2

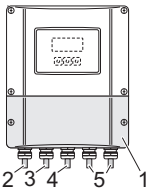

A0012690

Transmitter connection:

- 1 Connection diagram inside the connection compartment cover
- 2 Power supply cable
- 3 Electrode cable
- 4 Fieldbus cable

Connecting the connecting cable (→ 45):

- 5 Sensor/transmitter connecting cable

3.1.3 Remote version (transmitter): Ex Zone 1, Class I Div. 1

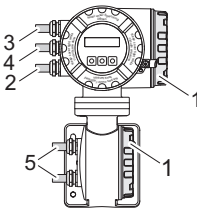

A0008218

Transmitter connection:

- 1 Connection diagram inside the connection compartment cover
- 2 Power supply cable
- 3 Electrode cable or fieldbus cable
- 4 Optional

Connecting the connecting cable (→ 45):

- 5 Sensor/transmitter connecting cable

3.1.4 Remote version (sensor)

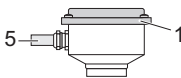

A0008037

Transmitter connection:

- 1 Connection diagram inside the connection compartment cover

Connecting cable connection:

- 5 Sensor/transmitter connecting cable

3.2 Connecting the remote version connecting cable

3.2.1 Connecting cable for Promag E/P/L/W

Connecting cable termination

Terminate the signal and coil current cables as shown in the figure below (Detail A). Fit the fine-wire cores with cable end ferrules (Detail B).

Electrode cable termination

Make sure that the cable end ferrules do not touch the wire shields on the sensor side! Minimum distance = 1 mm (0.04 in), exception "GND" = green cable.

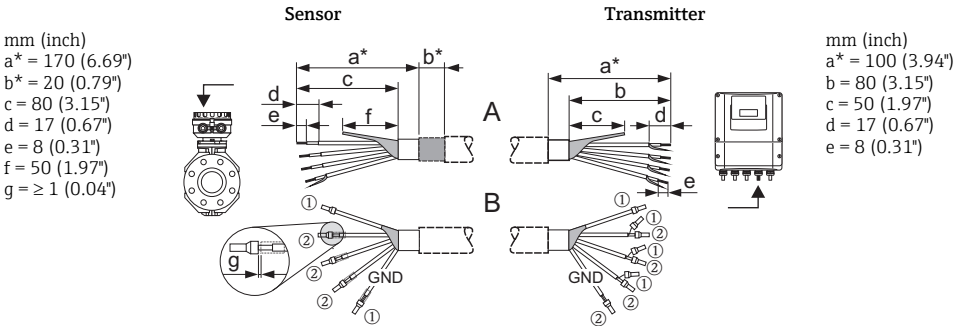

a0008171

① = Cable end ferrules, red, Ø 1.0 mm (0.04"); ② = Cable end ferrules, white, Ø 0.5 mm (0.02")
 * = Stripping for armored cables only

Coil current cable termination

Insulate one core of the three-core cable at the level of the core reinforcement; you only require two cores for the connection.

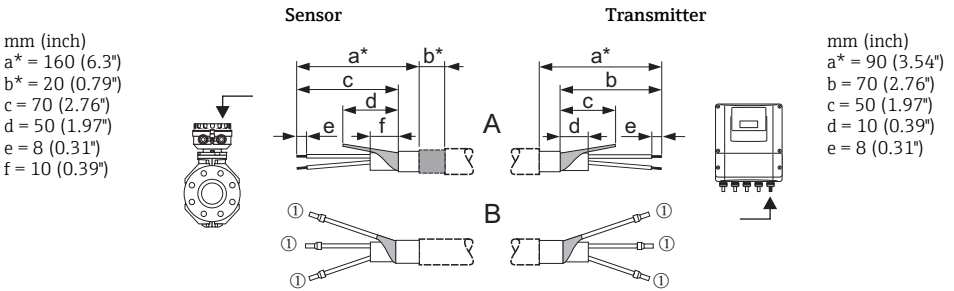

a0008172

① = Cable end ferrules, red, Ø 1.0 mm (0.04"); ② = Cable end ferrules, white, Ø 0.5 mm (0.02")
 * = Stripping for armored cables only

3.2.3 Connecting cable connection

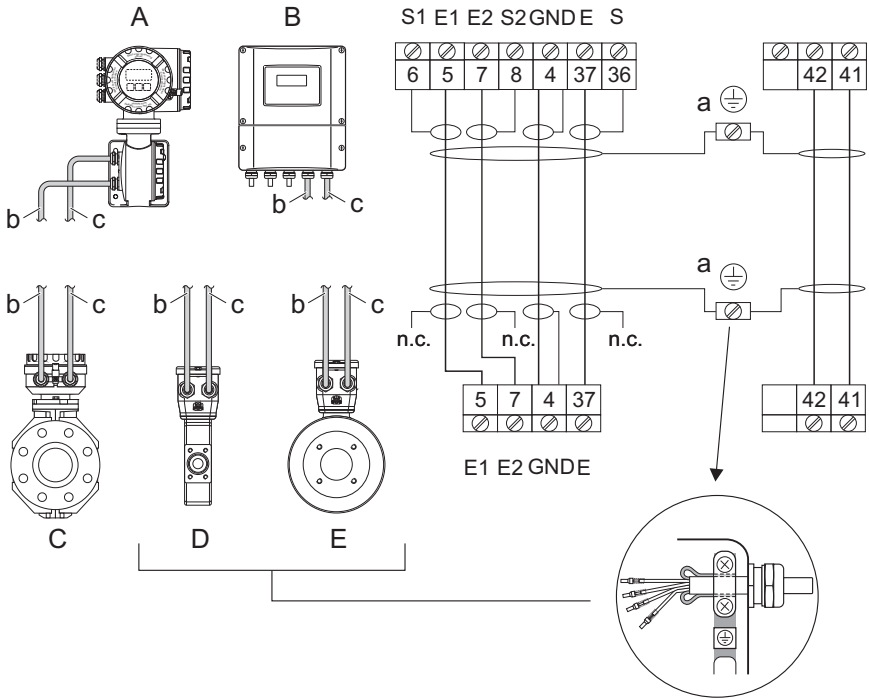

A0008180

- A Transmitter housing on connection housing, remote version
- B Wall-mount housing on connection housing, remote version
- C Sensor connection housing, remote version for Promag E/L/P/W
- D Sensor connection housing, remote version for Promag H, DN ≤ 25 (1")
- E Sensor connection housing, remote version for Promag H, DN ≥ 40 (1½")

- a Ground terminals (are provided for potential equalization connection)
- b Coil circuit connecting cable
- c Signal circuit connecting cable (electrodes)

n.c. = not connected, isolated cable shields

Cable colors for terminal numbers:

- 5/6 = brown
- 7/8 = white
- 4 = green
- 36/37 = yellow

3.3 Potential equalization

Perfect measurement is only ensured when the medium and the sensor have the same electrical potential. Most sensors have a reference electrode installed as standard, which guarantees the required potential connection. This usually means that the use of ground disks or other measures are unnecessary.

- Promag E/L/P/W
Reference electrode available as standard.
- Promag H
 - No reference electrode available. There is always an electrical connection to the fluid via the metal process connection.
 - In the case of plastic process connections, potential equalization must be ensured through the use of grounding rings.

Standard situation

Potential equalization takes place via the ground terminal of the transmitter when using the device in metal, grounded pipes.

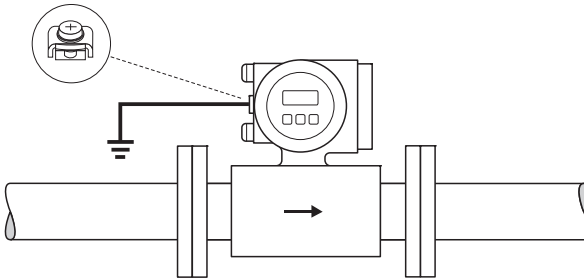

A0004375

Note! Potential equalization for other areas of application → Operating Instructions on the CD-ROM.

3.4 Degree of protection

The devices meet all the requirements for IP 67.

After mounting in the field or service work, the following points have to be observed to ensure that IP 67 protection is retained:

- Install the measuring device in such a way that the cable entries do not point upwards.
- Do not remove the seal from the cable entry.
- Remove all unused cable entries and plug them with suitable/certified drain plugs.
- Use cable entries and drain plugs with a long-term operating temperature range in accordance with the temperature specified on the nameplate.

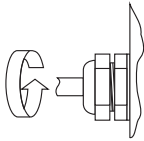

A0007549

Tighten the cable entries correctly.

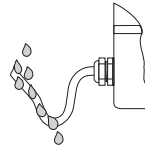

A0007550

The cables must loop down before they enter the cable entries ("water trap").

3.5 Post-connection check

- Are cables or the device damaged (visual inspection)?
- Does the supply voltage match the information on the nameplate?
- Do the cables used comply with the necessary specifications?
- Do the mounted cables have adequate strain relief and are they routed securely?
- Is the cable type route completely isolated? Without loops and crossovers?
- Only remote version:
 - Is the flow sensor connected to the matching transmitter electronics?
 - Is the connecting cable between sensor and transmitter connected correctly?
- Are all screw terminals firmly tightened?
- Have all the measures for grounding and potential equalization been correctly implemented?
- Are all cable entries installed, firmly tightened and correctly sealed?
- Cable routed as a "water trap" in loops?
- Are all the housing covers installed and securely tightened?

In addition, for measuring devices with fieldbus communication:

- Are all the connecting components (T-boxes, junction boxes, connectors, etc.) connected with each other correctly?
- Has each fieldbus segment been terminated at both ends with a bus terminator?
- Has the max. length of the fieldbus cable been observed in accordance with the specifications?
- Has the max. length of the spurs been observed in accordance with the specifications?
- Is the fieldbus cable fully shielded and correctly grounded?

4 Hardware settings

This section only deals with the hardware settings needed for commissioning. All other settings (e.g. output configuration, write protection, etc.) are described in the associated Operating Instructions on the CD-ROM.

Note! No hardware settings are needed for measuring devices with HART or FOUNDATION Fieldbus-type communication.

4.1 Device address

Has to be set for measuring devices with the following communication methods:

- PROFIBUS DP/PA

The device address can be configured via:

- Miniature switches → see description below
- Local operation → see **Software settings section** →  57

Addressing via miniature switches

Warning!

Risk of electric shock! Risk of damaging the electronic components!

- All the safety instructions for the measuring device must be observed and all the warnings heeded →  43.
- Use a workspace, working environment and tools purposely designed for electrostatically sensitive devices.

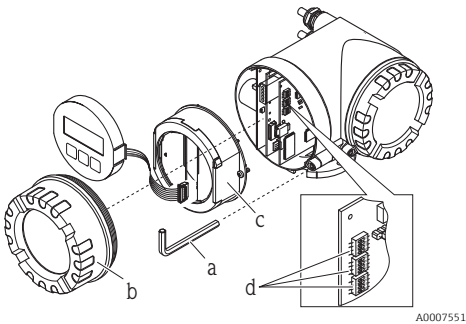

Warning!

Switch off the power supply before opening the device.

- Loosen the cheese head screw of the securing clamp with an Allen key (3 mm)
- Unscrew cover of the electronics compartment from the transmitter housing.
- Loosen the securing screws of the display module and remove the onsite display (if present).
- Set the position of the miniature switches on the I/O board using a sharp pointed object.

Installation is the reverse of the removal procedure.

PROFIBUS

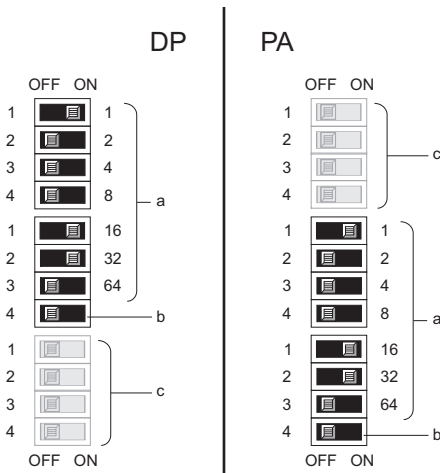

Device address range: 0 to 126
 Factory setting: 126

- a. Miniature switches for device address
 Example shown:
 $1+16+32 = \text{device address } 49$
- b. Miniature switches for the address mode (method of addressing):
 - OFF (factory setting) = software addressing via local operation/operating program
 - ON = hardware addressing via miniature switches
- c. Miniature switches not assigned.

A0007552

4.2 Terminating resistors

Note! If the measuring device is used at the end of a bus segment, termination is required.

This can be performed in the measuring device by setting the terminating resistors on the I/O board. Generally, however, it is recommended to use an external bus terminator and not perform termination at the measuring device itself.

Has to be set for measuring devices with the following communication methods:

- PROFIBUS DP
 - Baudrate ≤ 1.5 MBaud → Termination can be performed at the measuring device, see graphic
 - Baudrate > 1.5 MBaud → An external bus terminator must be used

Warning!

Risk of electric shock! Risk of damaging the electronic components!

- All the safety instructions for the measuring device must be observed and all the warnings heeded →  43.
- Use a workspace, working environment and tools purposely designed for electrostatically sensitive devices.

Setting the terminating switch SW1 on the I/O board:
ON - ON - ON - ON

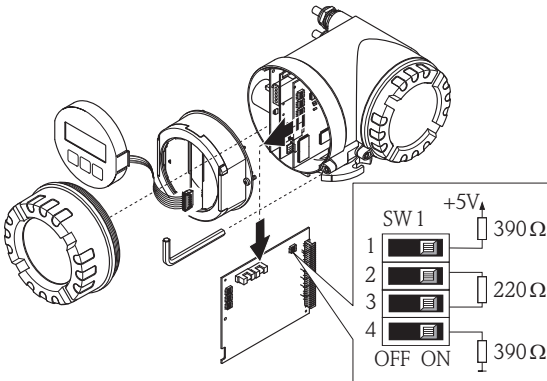

A0007556

5 Commissioning

5.1 Switching on the measuring device

On completion of the installation (successful post-installation check), wiring (successful post-connection check) and after making the necessary hardware settings, where applicable, the permitted power supply (see nameplate) can be switched on for the measuring device.

When the power supply is switched on, the measuring device performs a number of power-up checks and device self-checks. As this procedure progresses the following messages can appear on the onsite display:

Display examples:

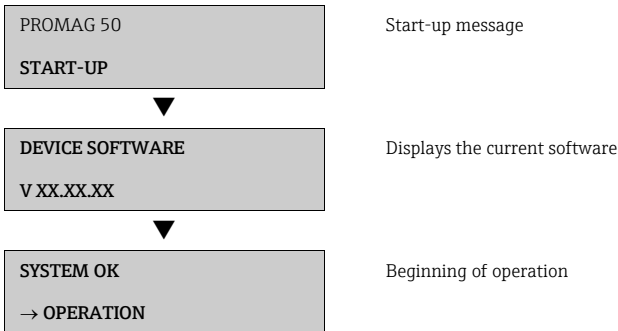

The measuring device starts operating as soon as the startup procedure is complete. Various measured values and/or status variables appear on the display.

Note! If an error occurs during startup, this is indicated by an error message.

The error messages that occur most frequently when a measuring device is commissioned are described in the Troubleshooting section → 📄 57.

5.2 Operation

5.2.1 Display elements

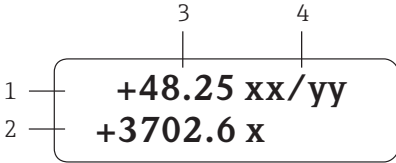

A0007557

Display lines/fields

1. Main line for primary measured values
2. Additional line for additional measured variables/status variables
3. Current measured values
4. Engineering units/time units

5.2.2 Operating elements

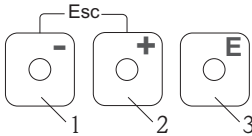

A0007559

Operating keys

1. (-) Minus key for entering, selecting
2. (+) Plus key for entering, selecting
3. Enter key for calling the function matrix, saving

When the +/- keys are pressed simultaneously (Esc):

- Exit the function matrix step-by-step:
- > 3 sec. = cancel data input and return to the measured value display

5.2.3 Displaying error messages

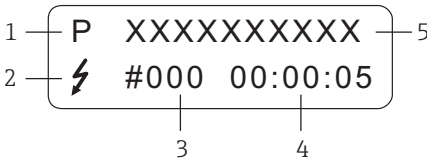

A0007561

1. Type of error:
P = Process error, S = System error
2. Error message type:
⚡ = Fault message, ! = Notice message
3. Error number
4. Duration of the last error that occurred:
Hours: Minutes: Seconds
5. Error designation
List of all error messages, see associated Operating Instructions on the CD-ROM

5.3 Navigating within the function matrix

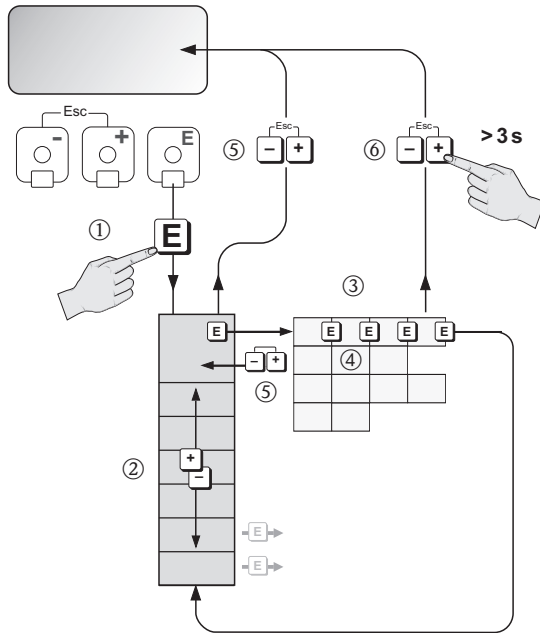













A0007562

1. → Enter the function matrix (starting with measured value display)
2. → Select the group (e.g. OPERATION)
 → Confirm selection
3. → Select function (e.g. LANGUAGE)
4. → Enter code **50** (only for the first time you access the function matrix)
 → Confirm entry
- Change function/selection (e.g. ENGLISH)
 → Confirm selection
5. → Return to measured value display step by step
6. > 3 s → Return immediately to measured value display

5.4 Calling the Commissioning Quick Setup

All the functions needed for commissioning are called up automatically with the Quick Setup. The functions can be changed and adapted to the process in question.

1.  → Enter the function matrix (starting with measured value display)
2.  → Select the group QUICK SETUP
 -  → Confirm selection
3. QUICK SETUP COMMISSIONING function appears.
4. Intermediate step if configuration is blocked:
 -  → Enter the code **50** (confirm with ) and thus enable configuration
5.  → Go to Commissioning Quick Setup
6.  → Select YES
 -  → Confirm selection
7.  → Start Commissioning Quick Setup
8. Configure the individual functions/settings:
 - Via -key, select option or enter number
 - Via -key, confirm entry and go to next function
 - Via -key, return to Setup Commissioning function (settings already made are retained)

Note! Observe the following when performing the Quick Setup:

- Configuration selection: Select the ACTUAL SETTING option
- Unit selection: This is not offered again for selection after configuring a unit
- Output selection: This is not offered again for selection after configuring an output
- Automatic configuration of the display: select YES
 - Main line = Mass flow
 - Additional line = Totalizer 1
 - Information line = Operating/system conditions
- If asked whether additional Quick Setups should be executed: select NO

All the available functions of the measuring device and their configuration options as well as additional Quick Setups, if available, are described in detail in the "Description of Device Functions" Operating Instructions. The related Operating Instructions can be found on the CD-ROM.

The measuring device is ready for operation on completion of the Quick Setup.

5.5 Software settings

5.5.1 Device address

Has to be set for measuring devices with the following communication methods:













- PROFIBUS DP/PA → device address range 0 to 126, factory setting 126

The device address can be configured via:

- Miniature switches → see Hardware settings →  50
- Local operation → see description below

Note! The COMMISSIONING SETUP must be executed before setting the device address.

Calling the Communication Quick Setup

1.  → Enter the function matrix (starting with measured value display)
2.  → Select the group QUICK SETUP
-  → Confirm selection
3.  → Select the QUICK SETUP COMMUNICATION function
4. Intermediate step if configuration is blocked:  → Enter the code **50**
(confirm with ) and thus enable the configuration
5.  → Go to Communication Quick Setup
6.  → Select YES;  → confirm selection
7.  → Start Communication Quick Setup
8. Configure the individual functions/settings:
 - Via -key, select option or enter number
 - Via -key, confirm entry and go to next function
 - Via -key, return to Setup Commissioning function
(settings already made are retained)

All the available functions of the measuring device and their configuration options as well as additional Quick Setups, if available, are described in detail in the "Description of Device Functions" Operating Instructions. The related Operating Instructions can be found on the CD-ROM.

The measuring device is ready for operation on completion of the Quick Setup.

5.6 Troubleshooting

A complete description of all the error messages is provided in the Operating Instructions on the CD-ROM.

Note! The output signals (e.g. pulse, frequency) of the measuring device must correspond to the higher-order controller.

www.addresses.endress.com
