



KONGSBERG

# INSTALLATION MANUAL

Simrad EK80







KONGSBERG

# ***Simrad EK80***

## ***Wide band scientific echo sounder***

### ***Installation Manual***

This manual provides you with the basic information required to install the Simrad EK80 Wide band scientific echo sounder. The manual is intended for technical personnel; such as skilled shipyard workers, electricians, qualified engineers and naval architects.

The EK80 software supports several different transceiver units. The information is mainly prepared for EK80 installations on a vessel. For installation of other transceivers supported by the EK80, see the relevant publications.

For information about the practical use of the EK80, refer to the EK80 *Reference Manual* and/or the EK80 context sensitive *On-line help*.

#### ***Caution***

---

***You must never set the EK80 to "ping" unless the transducer is submerged in water. Most transducers are damaged beyond repair if they transmit in open air. Prevent inadvertent use of the EK80 whenever a transducer is not submerged.***

---

Additional end-user documents related to the EK80 can be found on our website. This includes publications that are translated to other languages. Selected publications are also provided on IETM (*Interactive Electronic Technical Manual*) formats.

- <https://www.kongsberg.com/ek80>

**SIMRAD**  
By KONGSBERG

## Document information

- **Product:** Simrad EK80
- **Document:** Installation Manual
- **Document part number:** 394149
- **Document ISBN number:** 978-82-8066-182-1
- **Revision:** D
- **Date of issue:** 24 September 2020

## Copyright

*The information contained in this document remains the sole property of Kongsberg Maritime AS. No part of this document may be copied or reproduced in any form or by any means, and the information contained within it is not to be communicated to a third party, without the prior written consent of Kongsberg Maritime AS.*

## Warning

*The equipment to which this manual applies must only be used for the purpose for which it was designed. Improper use or maintenance may cause damage to the equipment and/or injury to personnel. You must be familiar with the contents of the appropriate manuals before attempting to operate or work on the equipment.*

*Kongsberg Maritime disclaims any responsibility for damage or injury caused by improper installation, use or maintenance of the equipment.*

## Disclaimer

*Kongsberg Maritime AS endeavours to ensure that all information in this document is correct and fairly stated, but does not accept liability for any errors or omissions.*

## Support information

If you require maintenance or repair, contact your local dealer. You can also contact us using the following address: [simrad.support@simrad.com](mailto:simrad.support@simrad.com). If you need information about our other products, visit <https://www.simrad.com>. On this website you will also find a list of our dealers and distributors.

## Table of contents

<b>ABOUT THIS MANUAL</b> .....	<b>11</b>
<b>SIMRAD EK80</b> .....	<b>13</b>
Important.....	14
System description.....	15
System diagram.....	17
Main system units .....	19
Display description.....	19
Processor Unit description.....	20
Ethernet switch description .....	21
Transceiver Unit description .....	21
Transducer description .....	23
Simrad EC150-3C .....	23
Scope of supply.....	25
Basic items provided with a standard delivery.....	25
Additional required items.....	27
Additional optional items .....	31
General safety rules.....	36
Installation requirements.....	37
Supply voltage requirements .....	37
Uninterruptible power supply (UPS) requirements.....	37
Cables and wiring requirements.....	38
Compass deviation requirements.....	38
Noise sources.....	38
Dry docking requirements .....	39
Requirement for classification approval.....	39
Network security.....	40
Support information.....	41
<b>PREPARATIONS</b> .....	<b>43</b>
Installation summary.....	44
About installation drawings .....	46
Tools, equipment and consumables required for EK80 installation .....	46
Personnel qualifications .....	47
Where to install the transducer .....	48
Mount the transducer deep .....	48
Avoid protruding objects near the transducer.....	49
Mount the transducer at forward part of hull to minimize the effects from the flow boundary water layer .....	50

Keep the transducer far away from the propellers .....	51
Mount the transducer at a safe distance from bow thruster(s) .....	51
Summary and general recommendations .....	52
Acoustic noise .....	54
Contributing factors .....	54
Self noise .....	56
Ambient noise .....	58
Fishing gear noise .....	59
Electrical self noise .....	59
Some means to reduce acoustic noise .....	59
Vessel coordinate system .....	61
<b>INSTALLING THE EK80 HARDWARE UNITS .....</b>	<b>64</b>
Installing the Wide Band Transceiver (WBT) using the integrated brackets .....	65
Installing the Wide Band Transceiver (WBT) in a 19" rack .....	67
Installing the WBT Power Supply .....	69
Installing the display .....	71
Installing a commercial computer .....	72
Installing the Enix Processor Unit .....	74
Installing the Ethernet switch .....	76
Mounting the WBT Cabinet .....	78
Mounting the drawers in the WBT Cabinet .....	81
Installing the transducer(s) .....	83
<b>CABLE LAYOUT AND INTERCONNECTIONS .....</b>	<b>85</b>
Read this first .....	86
Reducing electrical noise .....	86
Cable plans .....	88
About the cable plans .....	88
Topside cable plan .....	89
Sonar room cable plan with one transceiver .....	90
Sonar room cable plan with two transceivers .....	91
Sonar room cable plan with WBT Cabinet .....	92
EC150-3C cable plan .....	93
List of EK80 cables .....	94
Installing the EK80 cables .....	97
Prerequisites for cable installation .....	97
Installing the EK80 topside cables .....	98
Installing the Wide Band Transceiver (WBT) cables .....	100
Processor Unit rear connectors .....	102
Wide Band Transceiver (WBT) connectors .....	104
Using a steel conduit to protect the transducer cable .....	105

---

Splicing the transducer cable.....	107
Connections to specific hardware items.....	110
KVM (Keyboard Video Mouse) principle for a remote operating position .....	110
Processor Unit graphic adapter.....	112
Processor Unit serial adapter .....	114
Serial line splitter Øverland UPC-3005.....	118
Serial line splitter Øverland UPC-5000P.....	122
Setting up the EK80 in a synchronized system.....	126
About synchronization .....	126
Synchronization modes .....	127
Synchronization sequences.....	128
Synchronization using Clear To Send (CTS) and Request To Send (RTS) signals .....	129
Synchronization using the Auxiliary socket on the transceiver .....	129
Synchronizing the EK80 by means of a serial port .....	131
Synchronizing the EK80 by means of the Auxiliary port .....	134
Cable drawings and specifications .....	136
AC power cable using IEC C13 inline socket.....	137
Ground cable .....	139
RS-232 serial line connection using three wires .....	140
RS-232 serial line connection using five wires .....	141
RS-422 serial line connection using five wires .....	142
RS-232 used as synchronization trigger (input or output) .....	143
RS-485 serial line connection using two or four wires .....	144
Moxa CP114EL-I Serial line adapter .....	145
RJ45 High speed Ethernet cable (1000Base-t).....	147
Battery power cable.....	148
K-Sync interface to generic RS-232 synchronization input.....	148
Simrad TU40 interface to generic RS-232 synchronization input .....	151
Auxiliary connector for synchronization.....	153
Single beam low power transducer connection to a circular transducer socket .....	154
Split beam transducer connection to an Amphenol socket.....	156
Split beam transducer connection for single beam use on an Amphenol socket .....	159
Burton underwater connectors on split beam transducers for deep water.....	162
About serial lines.....	164
Basic cable requirements .....	167
Cable trays.....	167
Radio frequency interference .....	168

Physical protection of cables .....	168
Grounding of system cables .....	169
Cable connections and terminations .....	169
Cable identification .....	170
Cable glands and termination procedures .....	170
<b>DIMENSIONAL SURVEYING .....</b>	<b>176</b>
Quality assurance of EK80 data .....	177
Surveying the transducer and the navigation sensors .....	179
Dimensional survey accuracy requirements for ADCP operations .....	181
Dimensional survey accuracy requirements for echo sounding operations .....	182
Vessel coordinate system .....	182
<b>SETTING TO WORK .....</b>	<b>185</b>
Setting to work summary .....	186
Making sure that the EK80 is ready for operational use .....	188
Making sure that the AC mains supply voltage is correct .....	188
Making sure that all EK80 cables are properly connected .....	189
Visual inspection of the display .....	190
Visual inspection of the Processor Unit .....	192
Visual inspection of the Wide Band Transceiver (WBT) .....	193
Visual inspection of the WBT Cabinet .....	195
Visual inspection of the EC150-3C Power Supply Unit .....	197
Turning on the EK80 for the first time .....	199
Setting up summary .....	199
Installing the EK80 operational software .....	201
Turning on the EK80 to <i>Passive</i> mode .....	202
Obtaining and installing the software license .....	203
Defining the IP address on the Processor Unit network adapter for communication with the transceiver .....	205
Installing one or more transducers .....	206
Installing transceiver channels .....	210
Adjusting the screen resolution .....	212
Installing and troubleshooting Network Time Protocol (NTP) .....	214
Installing Network Time Protocol (NTP) .....	214
Installing Network Time Protocol (NTP) monitor .....	218
Troubleshooting the Network Time Protocol (NTP) service .....	222
Configuring the EK80 for normal operation .....	224
Selecting menu language .....	224
Selecting measurement units .....	225
Defining the raw data recording parameters .....	225
Interfacing peripheral equipment .....	228



---

Installing navigation sensors and other sensors .....	228
Defining the serial and Ethernet (LAN) port parameters .....	230
Setting up the input from a navigation system (GPS) .....	231
Configuring the sensor interface.....	234
Setting up a serial or LAN (Ethernet) port for annotation input .....	235
Connecting a catch monitoring system to a serial or LAN (Ethernet) port .....	237
Connecting a trawl system to a serial or LAN (Ethernet) port.....	239
Setting up the input from a motion reference unit (MRU).....	241
Setting up the input from a sound speed sensor .....	243
Setting up depth output to an external system.....	245
Exporting sensor data to a peripheral system .....	247
Synchronizing the EK80 by means of a serial port .....	249
Synchronizing the EK80 by means of the Auxiliary port .....	252
Setting up the interface between the EK80 and the Simrad TD50.....	254
Test procedures .....	256
Functional test of the EK80 Wide band scientific echo sounder .....	257
Measuring noise in passive operating mode.....	259
Reading the transceiver hardware and software versions .....	261
Verifying the communication with the course gyro .....	263
Verifying the communication with a navigation system (GPS) .....	265
Verifying the communication with speed log.....	267
Verifying the communication with the motion reference unit (MRU).....	269
Verifying the communication with a synchronization system.....	271
Making a noise/speed curve to determine vessel noise .....	273
Turning off the EK80 .....	276
Installation remarks.....	278
<b>TECHNICAL SPECIFICATIONS.....</b>	<b>279</b>
Introduction to technical specifications .....	280
Interface specifications.....	281
Supported datagram formats for annotation data .....	281
Supported datagram formats for distance information.....	282
Supported datagram formats for drop keel offset information.....	282
Supported datagram formats for external depth input.....	283
Supported datagram formats for position information .....	283
Supported datagram formats for heading and gyro information .....	284
Supported datagram formats for trawl information.....	284
Supported datagram formats for motion information.....	285
Supported datagram formats for palette control.....	286
Supported datagram formats for catch monitoring information.....	286
Supported datagram formats for sound speed sensors .....	287

Supported datagram formats for speed log information.....	288
Supported datagram formats for temperature information.....	288
Supported datagram formats for water level offset information .....	289
Supported formats for processed data to output.....	289
Supported formats for processed data to file .....	290
Power requirements .....	292
Display power requirements.....	292
Processor Unit power requirements .....	292
Wide Band Transceiver (WBT) power requirements.....	293
WBT Power Supply power requirements.....	293
LBG408A-R2 Ethernet switch power requirements .....	293
WBT Cabinet power requirements.....	294
Weights and outline dimensions .....	295
Display weight and outline dimensions.....	295
Processor Unit weight and outline dimensions .....	295
Wide Band Transceiver (WBT) weight and outline dimensions.....	296
LBG408A-R2 Ethernet switch weight and outline dimensions .....	296
WBT Cabinet weight and outline dimensions.....	297
Environmental requirements.....	298
Display environmental requirements.....	298
Processor Unit environmental requirements .....	298
Wide Band Transceiver (WBT) environmental requirements.....	299
LBG408A-R2 Ethernet switch environmental requirements .....	299
WBT Cabinet environmental requirements.....	299
Compass safe distance .....	301
Display compass safe distance .....	301
Processor Unit compass safe distance .....	301
Wide Band Transceiver (WBT) compass safe distance .....	301
WBT Power Supply compass safe distance .....	302
LBG408A-R2 Ethernet switch compass safe distance.....	302
WBT Cabinet compass safe distance .....	302
Minimum computer requirements.....	303
Minimum display requirements .....	304
<b>DRAWING FILE.....</b>	<b>306</b>
About the drawings in the drawing file.....	307
388697 Wide Band Transceiver (WBT) outline dimensions .....	308
385609 Processor Unit dimensions.....	310
400930 WBT Cabinet outline dimensions.....	314
201575 Transducer connector assembly and wiring.....	318
<b>EQUIPMENT HANDLING.....</b>	<b>320</b>

Transporting Kongsberg Maritime equipment.....	321
Lifting units and transportation boxes .....	322
Inspection of units and transportation boxes after arrival.....	323
Specifications for storage prior to installation or use.....	324
Unpacking instructions .....	325
Unpacking standard parts and units.....	326
Unpacking mechanical units .....	327
Unpacking electronic and electromechanical units .....	328
Unpacking transducers .....	329
Specifications for storage after unpacking.....	330



# About this manual

The purpose of this manual is to present the descriptions and drawings required to install the Simrad EK80 Wide band scientific echo sounder.

## Note

---

*The EK80 software supports several different transceiver units. The information is mainly prepared for EK80 installations on a vessel. For installation of other transceivers supported by the EK80, see the relevant publications.*

---

## Target audience

The manual is intended for technical personnel; such as skilled shipyard workers, electricians, qualified engineers and naval architects. It is assumed that you understand the general principles of maritime electronic equipment. You must also be familiar with computer hardware, interface technology and installation of electronic and mechanical products.

## Installation instructions

The instructions provided in this manual must be followed carefully to ensure optimal performance. As a guide, installation procedures are presented in the order they must be done.

The equipment described in this manual includes the complete system with relevant cabinets. Units provided locally by the customer, installation shipyard or local representative are not described.

Information about third party products and/or services may not be included in this manual, even though these may be provided as a part of the EK80 delivery. Refer to the relevant end-user documentation provided by the manufacturer.

## Note

---

*Kongsberg Maritime AS will accept no responsibility for any damage or injury to the system, vessel or personnel caused by equipment that has been incorrectly installed or maintained, or by drawings, instructions or procedures that have not been prepared by us.*

---

### **Installation drawings**

The installation shipyard must provide all necessary design and installation drawings, as well as the relevant work standards and mounting procedures. The installation shipyard must design and manufacture relevant installation hardware to fit each individual hardware unit.

#### **Note**

---

*If required, all documents provided by the shipyard for the physical installation of the EK80 must be approved by the vessel's national registry and corresponding maritime authority and/or classification society. Such approval must be obtained before the installation can begin. The shipowner and shipyard doing the installation are responsible for obtaining and paying for such approval.*

---

The outline dimensions of the EK80 units are found in the *Drawing file* chapter in this manual.

The source drawings (normally in AutoCad format) can be downloaded from our website.

- <https://www.kongsberg.com/ek80>

### **Online information**

All end-user manuals provided for operation and installation of your Simrad EK80 can be downloaded from our website.

- <https://www.kongsberg.com/ek80>

Our website also provides information about other Simrad products.

### **Registered trademarks**

Observe the registered trademarks that apply.

Windows® is a registered trademark of Microsoft Corporation in the United States and other countries.

Simrad®, SIMRAD® and the Simrad® logo are either registered trademarks, or trademarks of Kongsberg Maritime AS in Norway and other countries.

### **We want your feedback**

We want to improve EK80 continuously. We also want our end-user documentation to be comprehensive and relevant. You can help. Please provide comments, suggestions or constructive criticism to any of our support offices.

# Simrad EK80

## Topics

[Important, page 14](#)

[System description, page 15](#)

[System diagram, page 17](#)

[Main system units, page 19](#)

[Scope of supply, page 25](#)

[General safety rules, page 36](#)

[Installation requirements, page 37](#)

[Network security, page 40](#)

[Support information, page 41](#)

## Important

The EK80 is an advanced product. It is used with other advanced products. There is important information that you need to know.

### Note

---

*The EK80 software supports several different transceiver units. This publication is mainly intended for vessel installations of EK80 using the Wide Band Transceiver (WBT).*

---

### Before you turn on the EK80

Before you turn on the EK80, make sure that the transducer is submerged in water. If you are using a drop keel, make sure that you have sufficient water depth to lower it.

### Caution

---

*You must never set the EK80 to "ping" unless the transducer is submerged in water. Most transducers are damaged beyond repair if they transmit in open air. Prevent inadvertent use of the EK80 whenever a transducer is not submerged.*

---

### When the EK80 is not used

When you do not use the EK80, turn off the display and the Processor Unit. If you are not using the EK80 for a long period of time, we recommend that you turn off the transceiver(s).

### When you are docking your vessel

You must never turn on the EK80 when the ship is in dry dock. The transducer(s) may be damaged if the EK80 transmits in open air. To prevent inadvertent use of the EK80, pull out the mains plug on the Processor Unit whenever your vessel is in dry dock. Additional precautionary measures should be considered.

### If something breaks down

If you believe that something has broken down, contact your local dealer. A list of all our dealers is provided on our website.

- <https://www.kongsberg.com>

If you are unable to contact a dealer, observe the support information in this publication.

### When you want to turn off the EK80

You must never turn off the EK80 by means of the on/off switch on the Processor Unit. You must ALWAYS select **Exit** on the top bar.



## Note

---

*If you turn off the EK80 by means of the on/off switch on the Processor Unit you may damage the software and the interface settings used to communicate with external devices.*

---

## Rules for transducer handling

A transducer must always be handled as a delicate instrument. Incorrect actions may damage the transducer beyond repair. Observe these transducer handling rules:

- **Do not** activate the transducer when it is out of the water.
- **Do not** handle the transducer roughly. Avoid impacts.
- **Do not** expose the transducer to direct sunlight or excessive heat.
- **Do not** use high-pressure water, sandblasting, metal tools or strong solvents to clean the transducer face.
- **Do not** damage the outer protective skin of the transducer face.
- **Do not** lift the transducer by the cable.
- **Do not** step on the transducer cable.
- **Do not** damage the transducer cable, and avoid exposure to sharp objects.

## Related topics

[Simrad EK80, page 13](#)

[Support information, page 41](#)

# System description

The Simrad EK80 is the most modern high-end split-beam scientific echo sounder in the scientific market. Based on more than 60 years of research and development in close collaboration with leading marine scientists this wideband echo sounder system has succeeded the famous EK60, which became an international standard for fish stock assessment.

The Simrad EK80 is the natural choice for modern research vessels and environmental monitoring installations requiring high quality scientific data for resource management and cutting edge research.

The EK80 supports hull mounting transducers, but it is also well suited for portable use. Pulses sweeping over a wide frequency band (FM) and the traditional discrete frequencies (CW) are available. Wide band sweeps provide long range without compromising target resolution. Continuous frequency responses over a wide band improve target identification and discrimination. Split beam calibration is implemented for both FM and CW modes.

Real time echo integration and target strength analysis in an unlimited number of layers is provided as well as storage of raw data for replay or analysis in one of several post-processing software packages. Several post-processing alternatives are available for survey analysis and reporting.

By means of a common and well documented RAW data format, EK80 data can be collected and integrated across a variety of acoustic platforms.

The Simrad EK80 can operate a large number of frequencies simultaneously ranging from 10 to 500 kHz. A wide selection of high quality accurate transducers is available.

The EK80 uses Microsoft® Windows® operating system. It can operate with single and/or split beam transducers, and provides you with a dedicated built-in application for calibration. The EK80 is specifically suited for permanent installation onboard a research vessel. It is still compact and a natural choice for portable use.

The Simrad EK80 is well suited for a number of applications:

- Assessment of fish biomass and distribution
- Species identification and discrimination
- Plankton research
- Habitat mapping
- Behavioral studies
- Environmental research
- Oil and gas detection

The echo sounder system is modular, and you can assemble any combinations of transceivers and transducers to fit your purposes. In a typical configuration, the EK80 comprises:

- A Display
- B One Processor Unit
- C One or more transceiver units
- D An Ethernet switch (if more than one transceiver is used)
- E One or more single- or split beam transducers

The EK80 can work with several transceivers. This includes relevant hardware for acoustic Doppler current profiling (ADCP) operation.

### **Related topics**

[Simrad EK80, page 13](#)

[Main system units, page 19](#)

[Scope of supply, page 25](#)

## System diagram

The system diagram identifies the main components of a basic EK80 system. Only the main connections between the units are shown. Detailed interface capabilities and power cables are not shown.

In this publication, the computer is referred to as the Processor Unit.

### Basic system

The basic Simrad EK80 Wide band scientific echo sounder consists of one transducer, one Wide Band Transceiver (WBT) and one Processor Unit. Additional transceivers and transducers can be added to meet your operational and functional requirements. Post-processing software is provided by third-party suppliers. See our website for more information.

Unless otherwise specified in a contract, the display and the Ethernet switch are not included in the standard delivery from Kongsberg Maritime. These are commercial items that can be purchased locally.

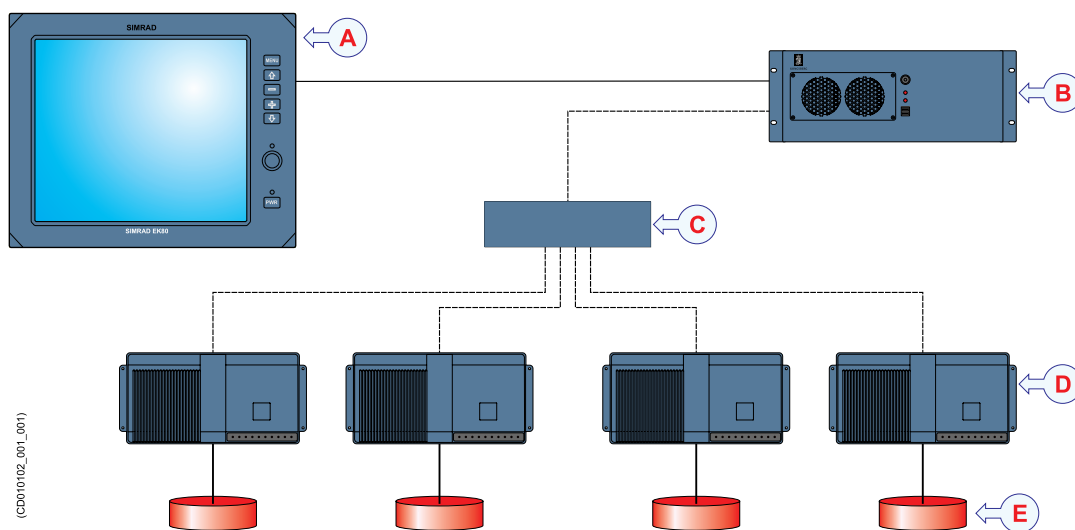

- A *Display*
- B *Processor Unit*
- C *Ethernet switch*
- D *Wide Band Transceiver (WBT)*
- E *Transducers*

### System with acoustic Doppler current profiler (ADCP) functionality

The EK80 can be expanded by adding dedicated hardware for acoustic Doppler current profiler (ADCP) measurements. The following ADCP systems are currently supported:

- Simrad EC150-3C

The Simrad EC150-3C is a 150 kHz phased-array transducer designed for current profiling applications. It offers 2.8 degrees beamwidth for accurate current profiling and 2.5 degrees beamwidth when applied as a split-beam echo sounder transducer. The EC150-3C housing includes the required transceiver circuitry.

The EC150-3C is a dual purpose unit. It can be used *either* as an acoustic Doppler current profiler (ADCP) instrument to measure water current *or* as a split-beam echo sounder. It can not operate these two functions simultaneously.

The ADCP hardware can be added to an existing EK80 system. You can also use the EK80 as an exclusive ADCP instrument.

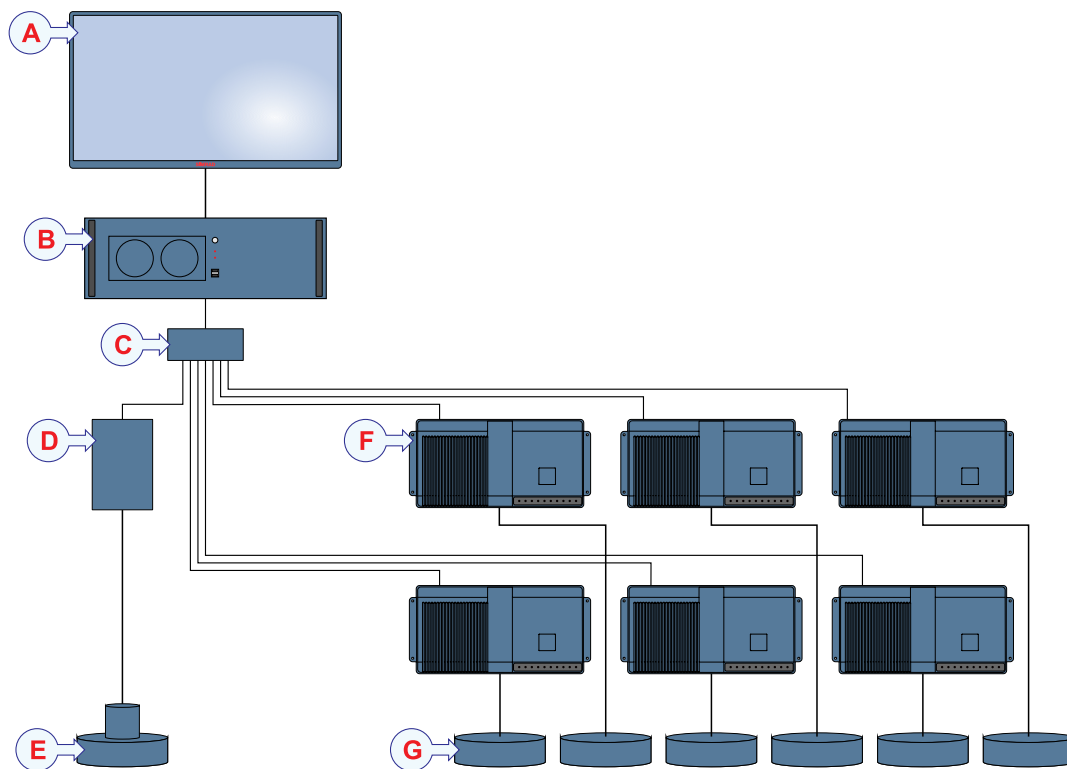

- A *Display*
- B *Processor Unit*
- C *Ethernet switch*
- D *Power Supply Unit*
- E *Simrad EC150-3C*
- F *Wide Band Transceiver (WBT)*
- G *Transducers*

**Related topics**

- [Simrad EK80, page 13](#)
- [Main system units, page 19](#)
- [Scope of supply, page 25](#)

## Main system units

### Topics

[Display description, page 19](#)

[Processor Unit description, page 20](#)

[Ethernet switch description, page 21](#)

[Transceiver Unit description, page 21](#)

[Transducer description, page 23](#)

[Simrad EC150-3C, page 23](#)

### Display description

A display is a required part of the EK80 Wide band scientific echo sounder. For best readability, the display must be protected from glare and have the correct height and angle.

Any commercial display can be used with the EK80 Wide band scientific echo sounder, provided that the display meets the minimum requirements.

You may wish to see many echogram channels simultaneously. A large display with high resolution is then useful. The EK80 software supports all display sizes. The visual quality of the EK80 presentation depends on the quality of your graphic adapter and display.

#### Note

---

*The display is not a standard part of the EK80 delivery. This is a commercial item that can be purchased locally.*

---

The chosen display must be designed for maritime use, and it must meet the minimum performance specifications. You must also make sure that the chosen display supports the video formats provided by the Processor Unit. Kongsberg Maritime may provide a suitable display.

#### Tip

---

*Many computers have two video ports. Two displays can therefore be used to see the EK80 presentations. You can place the two displays next to each other. You can also choose to place the second display at another location on the vessel.*

*The presentation on the second display is controlled using the operating system features on the Processor Unit.*

---

### Related topics

[Main system units, page 19](#)

[Simrad EK80, page 13](#)

[Minimum display requirements, page 304](#)

## Processor Unit description

The Processor Unit is the computer that controls the EK80 system. It is a vital part of the EK80 Wide band scientific echo sounder. The Processor Unit contains the operational software, and offers the user interface that allows you to control the EK80. Furthermore, it offers a number of serial and Ethernet lines for communication with external devices. In this publication, the computer is referred to as the Processor Unit.

The computer must meet the operating system requirements provided by Microsoft®. The computer must also provide the necessary interface facilities that your EK80 needs to communicate with peripheral systems. The computer must be designed for rugged use, and the construction must be able to withstand the vibrations and movements of a vessel. The operating system must be Microsoft® Windows 10.



A high quality Ethernet adapter is required. If you wish to connect the Processor Unit to the ship's network, you need two Ethernet adapters.

The Processor Unit is normally mounted on the bridge or in a scientific laboratory.

### Note

---

*The Ethernet adapter communicating with the Wide Band Transceiver (WBT) must offer a **Receive Buffers** function. This parameter must be set to its maximum value if more than one Wide Band Transceiver (WBT) is used.*

---

The Processor Unit is not a standard part of the EK80 delivery. A suitable computer may be provided with the EK80. The Processor Unit is designed for rugged maritime use. It has been customized by Kongsberg Maritime. Except from the fans, it contains no moving parts. The computer is based on a commercial design, but the software and hardware have been specified by Kongsberg Maritime to suit the EK80 requirements. It is set up with all necessary software. Consult your local dealer or agent for more information.

The EK80 design supports two displays. This can be a practical solution. You can place the two displays next to each other. You can also choose to place the second display at another location on the vessel.

### Related topics

[Main system units, page 19](#)

[Simrad EK80, page 13](#)

[385609 Processor Unit dimensions, page 310](#)

[Minimum computer requirements, page 303](#)

## Ethernet switch description

A high capacity Ethernet switch is a key component of the EK80 system.

If you use more than one Wide Band Transceiver (WBT), a high capacity Ethernet switch is required. The Ethernet switch is used to connect each Wide Band Transceiver (WBT) to the Processor Unit.

### Related topics

[Main system units, page 19](#)

[Simrad EK80, page 13](#)

## Transceiver Unit description

The EK80 Wide Band Transceiver (WBT) is provided to transmit acoustic energy through water. This transmission and reception are commonly referred to as a *ping*. After each transmission, the transceiver receives the echoes from the targets in the water and/or the seabed. These echoes are filtered and amplified and then converted into digital format.

The EK80 software supports several different transceiver units. Several transceivers may be used simultaneously.

### Wide Band Transceiver (WBT)

The Wide Band Transceiver (WBT) comprises a rugged box providing all necessary transmitter and receiver electronics. The receiver is designed for low noise, and it can handle input signals spanning a very large instantaneous dynamic amplitude range. All targets are correctly measured. The transceiver operates within a large frequency band, and supports single frequencies, frequency sweep (chirp) and user defined wave forms.



The Wide Band Transceiver (WBT) is designed for applications where performance is the top priority. It has four 500 W channels that can either work independently with single beam transducers, or together with a split beam transducer. The design is optimized for applications where power consumption and physical size is not critical.

A high quality Ethernet cable connects the Wide Band Transceiver (WBT) to the Processor Unit. The distance between the Processor Unit and the transceiver can be extended up to maximum 70 meters. If a longer cable is required, cut it in half, and insert an Ethernet switch to provide buffer amplification.

The Wide Band Transceiver (WBT) requires an external power supply offering 12 to 15 Vdc, minimum 5 A. A suitable power supply is provided with the delivery. The transceiver can also be powered by a large capacity battery.

Note

---

*If more than one Wide Band Transceiver (WBT) is used, a small high capacity Ethernet switch is required to connect the transceivers to the Processor Unit.*

---

### WBT Mini

The WBT Mini is a compact version of the highly efficient Wideband Transceiver (WBT) used by marine research vessels all around the world. Typical deployments include portable echo sounders and any other surface platforms that may benefit from its compact size and energy-efficient design. The WBT Mini has a small size, high capacity and low power consumption, and - as an option - autonomous operation.



The transceiver electronics in the WBT Mini have the linear FM (chirp) and CW pulse forms similar to the Wideband Transceiver. It contains four individual transceiver channels with multiplexing functionality. This allows for great flexibility when you set up a system with various split-beam or single-beam transducer configurations.

The WBT Mini is contained in a splash-proof cabinet. The robust design allows long-term deployment in challenging environments. The WBT Mini requires an external power supply.

### WBT Tube

The WBT Tube is a depth rated version of the highly efficient Wide Band Transceiver (WBT) used by marine research vessels all around the world. The WBT Tube is contained in a pressure rated tube. It is designed for long term use down to 4000 metres water depth. Typical deployments include moorings, subsea structures for environmental monitoring and probes.

The shape and pressure rating makes the WBT Tube an ideal solution for subsea structures with multiple sensors. Each WBT Tube contains two independent transceiver boards as well as a multiplexed output. This makes it possible to ping on *two* split-beam transducer simultaneously, or *four* split-beam transducers using alternate pinging on two at a time.

The transceiver electronics in the WBT Tube have the same linear FM (chirp) and CW pulse forms as the Wide Band Transceiver. It contains eight individual transceiver channels with multiplexing functionality. This allows for great flexibility when you set up a system with various split-beam or single-beam transducer configurations.

The WBT Tube requires an external power supply. Two versions are available, one for 15 VDC operation, and one for or 24 VDC. It communicates with the computer using one high speed Ethernet line for each transceiver in use.



**Related topics**

[Main system units, page 19](#)

[Simrad EK80, page 13](#)

[388697 Wide Band Transceiver \(WBT\) outline dimensions, page 308](#)

## Transducer description

The EK80 Wide band scientific echo sounder can be used with all our single-beam and split-beam transducers.

Kongsberg Maritime can provide a wide range of efficient and accurate Simrad transducers for the EK80 Wide band scientific echo sounder. A large number of operational frequencies is available.

All our transducers are designed to work optimally across a large bandwidth and in demanding environments. For scientific echo sounders, we divide the features of the transducers into three main categories; split-beam, wideband and depth-rated. Several transducers fit into more than one category.

For more information about our transducers, see our website.

- <https://www.kongsberg.com/simrad>

The installation of the transducer (or transducers) is not described in detail in this manual. See the documentation provided with each transducer.

**Related topics**

[Main system units, page 19](#)

[Simrad EK80, page 13](#)

## Simrad EC150-3C

The Simrad EC150-3C is a 150 kHz phased-array transducer designed for current profiling applications. It offers 2.8 degrees beamwidth for accurate current profiling and 2.5 degrees beamwidth when applied as a split-beam echo sounder transducer. The EC150-3C housing includes the required transceiver circuitry.

The EC150-3C is delivered with a power supply unit and an open-ended cable. The transducer cable is 40 metres long. One end of the cable is connected to the transducer. The other end is terminated in the power supply.

The transducer is normally mounted flush with the hull plating or the bottom of a blister. A clamping ring is used to secure the transducer body to a mounting ring. The mounting ring is welded into the hull plating.

The transducer can also be flush mounted in the same manner at the bottom of a blister or a drop keel.

The transducer cable penetrates the hull using a cable gland. This cable gland consists of a bushing, washers, a rubber gasket and a packing nipple.



#### **Related topics**

[Main system units, page 19](#)

[Simrad EK80, page 13](#)

## Scope of supply

### Topics

Basic items provided with a standard delivery, page 25

Additional required items, page 27

Additional optional items, page 31

### Basic items provided with a standard delivery

To assemble a complete EK80 system, you will need a set of system units. The main units required are provided with the standard delivery. Other required units may be purchased from Kongsberg Maritime or obtained locally. Some units are optional.

When you unpack the parts provided with the EK80 delivery, make sure that the following items are included.

#### Wide Band Transceiver (WBT)

One or more Wide Band Transceiver (WBT) units are provided.

Item	Order number	In the box
WBT (10 - 30 kHz)	402578	Transceiver Unit Power Supply Unit Installation bracket for WBT Power supply Documentation Software Software license
WBT (25 - 50 kHz)	402579	
WBT (45 - 90 kHz)	402580	
WBT (85 - 170 kHz)	402581	
WBT (150 - 300 kHz)	402582	
WBT (250 - 500 kHz)	402583	

An *order number* is the unique identifier used when a unit or an item is ordered. The number identifies a complete unit and relevant accessories packed in its shipping container.

#### Operational software

Operational software is provided on a suitable media. If the Processor Unit is purchased from Kongsberg Maritime, the operational software is installed on the Processor Unit, and ready for use.

#### End-user documentation

End-user documentation is provided on paper and/or digital formats. All documentation related to operation and installation can be downloaded from our website.

- <https://www.kongsberg.com/ek80>

**Related topics**

[Scope of supply, page 25](#)

[Simrad EK80, page 13](#)

[385609 Processor Unit dimensions, page 310](#)

[388697 Wide Band Transceiver \(WBT\) outline dimensions, page 308](#)

## Additional required items

Additional items are available for the EK80. Some are required for EK80 operation. These items must be added to the EK80 for full operational functionality. The additional items can be provided by Kongsberg Maritime. You can order them with the other basic EK80 items. You can also purchase these items from your dealer, agent or local supplier.

### Topics

[Display, page 27](#)

[Processor Unit, page 28](#)

[Transducers, page 28](#)

[Ethernet switch, page 29](#)

[Motion Reference Unit \(MRU\), page 29](#)

### Display

The display is not a standard part of the EK80 delivery. This is a commercial item that can be purchased locally.

Any commercial display can be used with the EK80 Wide band scientific echo sounder, provided that the display meets the minimum requirements. The chosen display must be designed for maritime use, and it must meet the minimum performance specifications. You must also make sure that the chosen display supports the video formats provided by the Processor Unit.

We suggest that you purchase a large high-resolution display.

Kongsberg Maritime may provide a suitable display.

Display	Order number	In the box
Hatteland JH19T14	335513	Display (19", 1280 x 1024) Power cable Documentation
	339785	Mounting hardware
Isic DuraMON WS MD24	383050	Display (24", 1920 x 1080) Power cable Documentation
	354265	Mounting bracket
Isic DuraMON MD24 Glass	417776	Display (24", 1920 x 1080) Power cable Documentation
	419970	Mounting bracket

An *order number* is the unique identifier used when a unit or an item is ordered. The number identifies a complete unit and relevant accessories packed in its shipping container.

**Related topics**

- [Additional required items, page 27](#)
- [Scope of supply, page 25](#)
- [Simrad EK80, page 13](#)
- [Minimum display requirements, page 304](#)

**Processor Unit**

The computer is not a standard part of the EK80 delivery. This is a commercial item that can be purchased locally.

The Simrad EK80 system is designed to be controlled by a maritime computer. The computer must be designed for rugged use, and the construction must be able to withstand the vibrations and movements of a vessel. The computer must also provide the necessary interface facilities that your EK80 needs to communicate with peripheral systems. A laptop computer can be used if it meets the technical requirements for EK80 operation.

The operating system must be Microsoft® Windows 10 or later. The computer must meet the operating system requirements provided by Microsoft®.

**Note**

---

*In this publication, the computer is referred to as the Processor Unit.*

---

A suitable computer may be provided with the EK80. Consult your local dealer or agent for more information.

Item	Order number	In the box
Processor Unit	395236	Computer Software Power cable Serial line connectors and adapters
<p><i>An order number is the unique identifier used when a unit or an item is ordered. The number identifies a complete unit and relevant accessories packed in its shipping container.</i></p>		

**Related topics**

- [Additional required items, page 27](#)
- [Scope of supply, page 25](#)
- [Simrad EK80, page 13](#)
- [Minimum computer requirements, page 303](#)

**Transducers**

The EK80 Wide band scientific echo sounder must be connected to one or more transducers.

Kongsberg Maritime can provide a wide range of efficient and accurate Simrad transducers for the EK80 Wide band scientific echo sounder. A large number of operational frequencies is available.

For more information about our transducers, see our website.

- <https://www.kongsberg.com/td>

### **Related topics**

[Additional required items, page 27](#)

[Scope of supply, page 25](#)

[Simrad EK80, page 13](#)

### **Ethernet switch**

If you use more than one Wide Band Transceiver (WBT), a high capacity Ethernet switch is required. The Ethernet switch is used to connect each Wide Band Transceiver (WBT) to the Processor Unit.

### **Related topics**

[Additional required items, page 27](#)

[Scope of supply, page 25](#)

[Simrad EK80, page 13](#)

### **Motion Reference Unit (MRU)**

ADCP operations cannot take place without input from a motion reference unit (MRU). In order to operate correctly with the EC150-3C, the EK80 requires input from a motion reference unit (MRU).

#### **Note**

---

*Without the input from a motion reference sensor, the EK80 will not be able to compensate for the vessel movements. The input must be provided on the KM Binary datagram format.*

---

The EK80 has been designed to match the motion reference unit (MRU) sensors manufactured by our Seatex division. Descriptions of all available MRU types are provided on our website.

- <https://www.kongsberg.com/mru>

For the motion sensor unit (MRU) to communicate with the EK80, it must support the following interface format:

- **KM Binary**

KM Binary is a proprietary datagram format created by Kongsberg Maritime for general use. This format has very high resolution on timing and sensor parameters.

**Note**

---

*The EK80 only accepts one datagram format for motion data. If you choose to use this format, no other formats are accepted.*

---

Kongsberg Maritime may provide a suitable motion reference unit. Consult your local dealer or agent for more information.

Motion Reference Unit (MRU)	Order number	In the box
Seatex MRU	—	Motion Reference Unit (MRU) Documentation
An <i>order number</i> is the unique identifier used when a unit or an item is ordered. The number identifies a complete unit and relevant accessories packed in its shipping container.		

**Related topics**

[Additional required items, page 27](#)

[Scope of supply, page 25](#)

[Simrad EK80, page 13](#)



## Additional optional items

Additional items are available for the EK80. Some are optional for EK80 operation. These items may for example simplify the installation, or increase the functionality. You can order them with the other basic EK80 items. You can also purchase these items from your dealer, agent or local supplier.

### Topics

[WBT Cabinet with drawers, page 31](#)

[Secondary display, page 32](#)

[Global positioning system \(GPS\), page 32](#)

[Speed log, page 33](#)

[Course gyro, page 33](#)

[Motion Reference Unit \(MRU\), page 33](#)

[Serial line splitter, page 34](#)

[Uninterruptible power supply \(UPS\), page 35](#)

### WBT Cabinet with drawers

The WBT Cabinet is a customized 19"-inch instrument rack fitted with powerful shock absorbers. The cabinet can contain maximum seven custom drawers, and each of these will hold one Wide Band Transceiver (WBT) and its power supply. An Ethernet switch and a power distributor panel are included the bottom of the cabinet.

The WBT Cabinet is delivered with six drawers. Each WBT Drawer will hold one Wide Band Transceiver (WBT). The WBT Drawer is designed to fit into any commercial 19-inch rack. The drawers can be ordered separately for use in any 19" rack.

Item	Order number	In the box
WBT Cabinet	402244	19-inch rack (24U) WBT Drawers (6) Ethernet switch Power rail Shock absorbers Mounting hardware
WBT Drawer	400791	WBT Drawer Mounting hardware

An *order number* is the unique identifier used when a unit or an item is ordered. The number identifies a complete unit and relevant accessories packed in its shipping container.

### Related topics

[Additional optional items, page 31](#)

[Scope of supply, page 25](#)

[Simrad EK80, page 13](#)

[400930 WBT Cabinet outline dimensions, page 314](#)

## Secondary display

You can use one, two or three displays on your EK80 Processor Unit depending on personal and/or operational preferences. The display is not a standard part of the EK80 delivery. This is a commercial item that can be purchased locally.

Any commercial display can be used with the EK80 Wide band scientific echo sounder, provided that the display meets the minimum requirements. The chosen display must be designed for maritime use, and it must meet the minimum performance specifications. You must also make sure that the chosen display supports the video formats provided by the Processor Unit.

### Tip

---

*If the distance between the Processor Unit and your second display is considerable, we suggest that you use KVM (Keyboard Video Mouse) technology to preserve the video quality.*

---

Kongsberg Maritime may provide a suitable display. Consult your local dealer or agent for more information.

## Related topics

[Additional optional items, page 31](#)

[Scope of supply, page 25](#)

[Simrad EK80, page 13](#)

[Minimum display requirements, page 304](#)

## Global positioning system (GPS)

A global positioning system (GPS) must be connected to the EK80. When a global positioning system (GPS) connected to the EK80, the vessel's current geographical position can be presented in the user interface. It will also provide latitude and longitude information for the cursor and marker(s). In addition to navigational data, the global positioning system (GPS) can also be used to provide speed information.

### Note

---

*Most global positioning system (GPS) can provide course information, but this data is generally too inconsistent to provide a stable EK80 presentation.*

---

The global positioning system (GPS) interface requirements are:

- **Serial line:** Standard NMEA 0183 datagram formats
- **Ethernet (LAN) line:** Standard NMEA 0183 datagram formats

## Related topics

[Additional optional items, page 31](#)

[Scope of supply, page 25](#)

[Simrad EK80, page 13](#)

## Speed log

Provided that a speed log sensor is interfaced to the EK80, the vessel's current speed can be presented in the user interface. A speed log is normally not a part of the EK80 delivery.

In most cases a suitable sensor is already installed on the vessel. A global positioning system (GPS) with a compatible output format can also be used.

The speed log interface requirements are:

- **Serial line:** Standard NMEA 0183 datagram formats
- **Ethernet (LAN) line:** Standard NMEA 0183 datagram formats

## Related topics

[Additional optional items, page 31](#)

[Scope of supply, page 25](#)

[Simrad EK80, page 13](#)

## Course gyro

When a course gyro is connected to the EK80, the vessel's current heading can be presented in the user interface. A course gyro is not a part of the EK80 delivery.

### Note

---

*Without the input from a course gyro, the EK80 will not be able to present correct navigational information.*

---

In most cases a suitable course gyro is already installed on the vessel. A global positioning system (GPS) with a compatible output format can also be used.

The course gyro interface requirements are:

- **Serial line:** Standard NMEA 0183 datagram formats
- **Ethernet (LAN) line:** Standard NMEA 0183 datagram formats

## Related topics

[Additional optional items, page 31](#)

[Scope of supply, page 25](#)

[Simrad EK80, page 13](#)

## Motion Reference Unit (MRU)

For improved operational accuracy we suggest that you connect a motion reference unit (MRU) to the EK80.

Without the input from a motion reference sensor, the EK80 will not be able to compensate for the vessel movements. This lack of compensation will prevent the EK80 from providing correct echo information.

**Note**

*ADCP operations cannot take place without input from a motion reference unit (MRU). The input must be provided on the KM Binary datagram format.*

---

The EK80 has been designed to match the motion reference unit (MRU) sensors manufactured by our Seatex division. Descriptions of all available MRU types are provided on our website.

- <https://www.kongsberg.com/mru>

For the motion sensor unit (MRU) to communicate with the EK80, it must support the following interface format:

- **EM Attitude 3000**

The Kongsberg EM Attitude 3000 is a proprietary datagram format created by Kongsberg Maritime for use with digital motion sensors. It holds roll, pitch, heave and heading information. The datagram contains a 10-byte message.

**Note**

*The EK80 only accepts one datagram format for motion data. If you choose to use this format, no other formats are accepted.*

---

Kongsberg Maritime may provide a suitable motion reference unit. Consult your local dealer or agent for more information.

Motion Reference Unit (MRU)	Order number	In the box
Seatex MRU-D	–	Motion Reference Unit (MRU) Documentation
An <i>order number</i> is the unique identifier used when a unit or an item is ordered. The number identifies a complete unit and relevant accessories packed in its shipping container.		

**Related topics**

[Additional optional items, page 31](#)

[Scope of supply, page 25](#)

[Simrad EK80, page 13](#)

**Serial line splitter**

On large installations with many hydroacoustic systems, these often require the same navigational information from a single sensor.

Information such as current depth or speed is provided on serial format. One or more serial line splitters can be used to distribute the information from a single sensor to several different recipients.

Item	Part number	In the box
Serial line splitter	337775	Serial line splitter (Øverland UPC-5000P) The Øverland UPC-5000P serial line splitter offers two separate inputs and fifteen RS-232 and RS-422 outputs.
Serial line splitter	317156	Serial line splitter (Øverland UPC-3005) The Øverland UPC-3005 serial line splitter offers one input and eight RS-232 and RS-422 outputs.

### Related topics

[Additional optional items, page 31](#)

[Scope of supply, page 25](#)

[Simrad EK80, page 13](#)

### Uninterruptible power supply (UPS)

It is important to ensure continuous operation of the EK80 independent of varying quality of the vessel's mains supply. The use of an uninterruptible power supply is therefore recommended.

Uninterruptible power supply units are not included in the standard EK80 delivery. These items must be purchased locally.

Several commercial types are available. To choose the best power solution for your EK80 installation, consider environmental conditions, space available, the availability and duration of the batteries, and the power requirements of the EK80.

#### Note

*Make sure that the Uninterruptible Power Supply (UPS) does not generate switching noise in the same frequency band as the EK80.*

The minimum requirements for the uninterruptible power supply (UPS) are:

- **Input voltage:** The input voltage must fit vessel supply voltage.
- **Output voltage:** 230 VAC, 50 Hz
- **Output power:** The output power must exceed the requirements of the EK80.
- **Output form:** The output AC voltage must be a sine wave.

### Related topics

[Additional optional items, page 31](#)

[Scope of supply, page 25](#)

[Simrad EK80, page 13](#)

[Uninterruptible power supply \(UPS\) requirements, page 37](#)

## General safety rules

The following safety precautions must be followed at all times during installation and maintenance work:

### **WARNING**

---

***This equipment operates on 230 VAC at 50/60 Hz. This voltage is lethal! You must never work alone on high-voltage equipment!***

---

- You must always switch off all power before installation or maintenance work on the EK80 system.  
Use the main circuit breaker, and label the breaker with a warning sign that informs others that maintenance or installation work is in progress on the system.
- For safety reasons, two persons must always be present during troubleshooting with power ON.
- Read and understand the applicable first aid instructions related to electric shock.
- Whenever maintenance is in progress, it is essential that a first aid kit is available, and that all personnel are familiar with the first aid instructions for electrical shock.

# Installation requirements

## Topics

[Supply voltage requirements, page 37](#)

[Uninterruptible power supply \(UPS\) requirements, page 37](#)

[Cables and wiring requirements, page 38](#)

[Compass deviation requirements, page 38](#)

[Noise sources, page 38](#)

[Dry docking requirements, page 39](#)

[Requirement for classification approval, page 39](#)

## Supply voltage requirements

As a general rule, the supply voltage must be kept within  $\pm 10\%$  of the installation's nominal voltage.

The EK80 software supports several different transceiver units. The supply voltage must be kept within the specific requirement for each transceiver in the EK80 system. For detailed requirements, see the relevant data sheets and end user documentation.

Maximum transient voltage variations on the main switchboard's bus-bars must not exceed  $-15\%$  to  $+20\%$  of the nominal voltage (except under fault conditions).

## Related topics

[Installation requirements, page 37](#)

[Simrad EK80, page 13](#)

## Uninterruptible power supply (UPS) requirements

We recommend that the EK80 system is powered using an Uninterruptible Power Supply (UPS) with sine wave output.

The Uninterruptible Power Supply (UPS) must have the capacity to independently maintain power to the EK80 for a minimum of 10 minutes. This ensures that the EK80 can be turned off in a controlled manner in the event of a power failure.

## Related topics

[Installation requirements, page 37](#)

[Simrad EK80, page 13](#)

[Uninterruptible power supply \(UPS\), page 35](#)

## Cables and wiring requirements

Correct wiring is crucial for the operational performance of the EK80.

All cables running between system cabinets located in different rooms and/or on different decks must be supported and protected along their entire lengths using conduits and/or cable trays. Note that the cables must not be installed in the vicinity of high-power supplies and cables, antenna cables or other possible sources of interference.

All transducer cables must be run in steel conduits.

For more detailed information about cables and wiring, refer to the basic cable requirements.

### Related topics

[Installation requirements, page 37](#)

[Simrad EK80, page 13](#)

## Compass deviation requirements

EK80 units that are installed on the bridge may have an effect on the compass.

Once the installation is complete, the vessel must be swung with the EK80 in both operative and inoperative modes. The shipowner and captain are responsible for updating the compass deviation table accordingly with regard to the vessel's national registry and corresponding maritime authority.

### Related topics

[Installation requirements, page 37](#)

[Simrad EK80, page 13](#)

## Noise sources

The operational performance of the EK80 Wide band scientific echo sounder depends on the noise conditions. It is essential that the noise signature is as low as possible.

### Vessel noise

The vessel's hull, rudder(s) and propeller(s) must be thoroughly inspected in dry dock prior to installation.

Roughness below the water-line deformities in the shell plating and protruding obstacles can create underwater noise. These sources of turbulence must be smoothed or removed as best as possible.

### Note

---

*It is especially important that the propeller(s) are not pitted or damaged.*

---



### **Electrical noise**

The quality of the power supply is crucial to reduce noise. Electrical or electronic self noise is picked up or generated in any other part of the equipment than the transducer. The most common source of electrical self noise is hum. The hum is normally generated by a power supply. It is then picked up by the transducer cable and/or sensitive electronic circuitry. At higher frequencies – where rather wide bandwidths are necessary – the noise from components, transistors or other analogue electronic may be a limiting factor.

#### **Note**

---

*Ensure maximum physical distance between the Wide Band Transceiver (WBT) and the Power Supply Unit. This is important to reduce noise.*

---

### **Related topics**

[Installation requirements, page 37](#)

[Simrad EK80, page 13](#)

## **Dry docking requirements**

Whenever one or more transducers are mounted under the vessel's hull, special considerations must be made prior to dry docking.

Make sure that ample clearance is provided under the transducers when you are placing the vessel in dry dock. Do not place supporting blocks or structures in the vicinity of the transducers.

Note down the location of each transducer on the vessel's docking plan.

Prior to dry docking, turn off the EK80. If necessary, disengage the circuit breaker. Label the Processor Unit and/or the circuit breaker clearly to prevent anyone from accidentally turning on the EK80.

### **Related topics**

[Installation requirements, page 37](#)

[Simrad EK80, page 13](#)

## **Requirement for classification approval**

Classification approval is required for the EK80 installation.

The transducer installation must be approved by the vessel's national registry and corresponding maritime authority and/or classification society. The shipowner and shipyard doing the installation are responsible for obtaining and paying for such approval.

### **Related topics**

[Installation requirements, page 37](#)

[Simrad EK80, page 13](#)

## Network security

If a EK80 system is connected to a local area network, data security is important.

Equipment manufactured by Kongsberg Maritime is frequently connected to the vessel's local area network (LAN). When you connect a computer to a local area network you will always expose the data on that computer. All other computers connected to the same network may be able to access your data. Several threats may immediately occur:

- Remote computers can read the data.
- Remote computers can change the data.
- Remote computers can change the behaviour of the computer, for example by installing unwanted software.

Usually, two parameters are used to define the threat level:

- 1 The likelihood that any remote computer will do any of the above.
- 2 The damage done if a remote computer succeeds doing this.

Kongsberg Maritime has no information regarding the complete system installation on any vessel. Systems provided by Kongsberg Maritime are regarded as stand-alone offline systems. They are stand-alone even though they may be connected to a network for sensor interfaces and/or data distribution.

### Note

---

*No network safety applications are installed on Kongsberg Maritime computers. The computers are therefore not protected against viruses, malware or unintentional access by external users.*

---

Securing the EK80 system itself has no meaning unless there is a policy in place that secures all computers in the network. This policy must include physical access by trained and trusted users. The customer/end user of the EK80 system will always be in charge of defining and implementing a security policy, and providing the relevant network security applications.

### Note

---

*Kongsberg Maritime will not accept any responsibility for errors and/or damages caused by unauthorized use of or access to the EK80.*

---

### Related topics

[Simrad EK80, page 13](#)

## Support information

If you need technical support for your Simrad EK80 you must contact your local dealer, or one of our support departments. A list of all our offices and dealers is provided on our website. You can also contact our main support office in Norway.

### Norway (main office)

- **Company name:** Kongsberg Maritime AS / Simrad
- **Address:** Strandpromenaden 50, N3190 Horten, Norway
- **Telephone:** +47 33 03 40 00
- **Telefax:** +47 33 04 29 87
- **Website:** <https://www.kongsberg.com/simrad>
- **E-mail address:** [simrad.support@simrad.com](mailto:simrad.support@simrad.com)

### Spain

- **Company name:** Simrad Spain S.L.U
- **Address:** Partida Atalayas 20, 03570 Villajoyosa, Spain
- **Telephone:** +34 966 810 149
- **Telefax:** +34 966 852 304
- **Website:** <https://www.kongsberg.com/simrad>
- **E-mail address:** [simrad.spain@simrad.com](mailto:simrad.spain@simrad.com)

### France

- **Company name:** Simrad France
- **Address:** 5 rue de Men Meur, 29730 Guilvinec, France
- **Telephone:** +33 298 582 388
- **Telefax:** +33 298 582 388
- **Website:** <https://www.kongsberg.com/simrad>
- **E-mail address:** [simrad.france@simrad.com](mailto:simrad.france@simrad.com)

### USA

- **Company name:** Kongsberg Underwater Technology Inc / Simrad Fisheries
- **Address:** 19210 33rd Ave W, Suite A, Lynnwood, WA 98036, USA
- **Telephone:** +1 425 712 1136
- **Telefax:** +1 425 712 1193
- **Website:** <https://www.kongsberg.com/simrad>
- **E-mail address:** [fish.usa.support@simrad.com](mailto:fish.usa.support@simrad.com)

### Canada

- **Company name:** Kongsberg Mesotech Ltd.
- **Address:** 1598 Kebet Way, Port Coquitlam, BC, V3C 5M5, Canada
- **Telephone:** +1 604 464 8144
- **Telefax:** +1 604 941 5423
- **Website:** <https://www.kongsberg.com/simrad>
- **E-mail address:** [simrad.canada@simrad.com](mailto:simrad.canada@simrad.com)

### Malaysia

- **Company name:** Kongsberg Maritime Malaysia Sdn. Bhd
- **Address:** Unit 27-5 Signature Offices, The Boulevard, Mid Valley City, Lingkaran Syed Putra, 59200 Kuala Lumpur, Malaysia
- **Telephone:** +65 6411 7488
- **Telefax:** +60 3 2201 3359
- **Website:** <https://www.kongsberg.com/simrad>
- **E-mail address:** [simrad.asia@simrad.com](mailto:simrad.asia@simrad.com)

### Korea

- **Company name:** Kongsberg Maritime Korea Ltd
- **Address:** #1101 Harbor Tower, 113-1, Nampodong 6-Ga, Jung-Gu, Busan 600-046, Korea
- **Telephone:** +82 51 242 9933
- **Telefax:** +82 51 242 9934
- **Website:** <https://www.kongsberg.com/simrad>
- **E-mail address:** [simrad.korea@simrad.com](mailto:simrad.korea@simrad.com)

### China

- **Company name:** Kongsberg Maritime China Ltd
- **Address:** 555 Chuanqiao Road, China (Shanghai) Pilot Free Trade Zone, 201206, China
- **Telephone:** +86 21 3127 9888
- **Telefax:** +86 21 3127 9555
- **Website:** <https://www.kongsberg.com/simrad>
- **E-mail address:** [simrad.china@simrad.com](mailto:simrad.china@simrad.com)

### Related topics

[Simrad EK80, page 13](#)

# Preparations

## **Topics**

[Installation summary, page 44](#)

[About installation drawings, page 46](#)

[Tools, equipment and consumables required for EK80 installation, page 46](#)

[Personnel qualifications, page 47](#)

[Where to install the transducer, page 48](#)

[Acoustic noise, page 54](#)

[Vessel coordinate system, page 61](#)

## Installation summary

Installation of the EK80 is a demanding task that requires careful preparations, a number of specific procedures, wiring and required system settings.

### Context

An overall installation procedure is provided. This procedure does not describe any detailed tasks. Refer to the relevant tasks in this manual.

### Note

---

*In order to obtain maximum safety and EK80 performance, it is very important that the installation procedures in this manual are complied to. You must do the tasks in the order they are described. The vessel owner must make sure that the installation shipyard holds the applicable competence to perform the installation, and that the applicable maritime authorities are available to verify and certify the installation.*

---

The installation shipyard must provide all necessary design and installation drawings, as well as the relevant work standards and mounting procedures. If required, all documents provided by the shipyard for the physical installation of the EK80 must be approved by the vessel's national registry and corresponding maritime authority and/or classification society. Such approval must be obtained before the installation can begin. The shipowner and shipyard doing the installation are responsible for obtaining and paying for such approval.

### Procedure

- 1 Determine the physical location of the transducer (or transducers).

Necessary considerations must be taken to avoid acoustic and electric disturbances.

### Note

---

*The information in this document must be regarded as general guidelines and recommendations only. The installation shipyard must design and manufacture installation hardware to fit the transducer to each individual vessel.*

---

- [Where to install the transducer, page 48](#)
- [Acoustic noise, page 54](#)

- 2 Install each transducer.

Each transducer will penetrate the hull. For this reason, this is a crucial part of the installation.

**Note**

*The installation shipyard must provide all necessary design and installation drawings, as well as the relevant work standards and mounting procedures. If required, all documents provided by the shipyard for the physical installation of the EK80 must be approved by the vessel's national registry and corresponding maritime authority and/or classification society. Such approval must be obtained before the installation can begin. The shipowner and shipyard doing the installation are responsible for obtaining and paying for such approval.*

---

Relevant installation drawings are included with each transducer. The drawings (normally in AutoCad format) can be downloaded from our website.

- 3 Install the EK80 system units.

Note that some EK80 system units may be commercial. Unless ordered specifically these are not included in the delivery, and must be purchased locally.

- [Installing the EK80 hardware units, page 64](#)

- 4 Install the cables between the EK80 system units.

Observe the relevant cable plan, procedures, as well as the general requirements for cabling. This is described in the *Cable layout and interconnections* chapter. Observe the relevant cable plan, procedures, as well as the general requirements for cabling.

- [Cable layout and interconnections, page 85](#)

- 5 Install the cables between the EK80 and the relevant peripheral devices.

- 6 Turn on the EK80 for the first time, and set it to work.

**Note**

*In order to turn on the EK80 in a safe and correct manner, the relevant procedures must be complied to!*

---

- [Setting to work, page 185](#)

- 7 Do a complete EK80 system test.

The tests are described in *Setting to work* chapter in this manual. They are also provided in the *Harbour Acceptance Test* and the *Sea Acceptance Test* documents.

- [Setting to work, page 185](#)

**Further requirements**

Fill in and sign the *Installation Remarks* form, and send it to the Simrad support department as specified on the form.

**Related topics**

[Preparations, page 43](#)

## About installation drawings

The installation shipyard must provide all necessary design and installation drawings, as well as the relevant work standards and mounting procedures.

### Note

---

*If required, all documents provided by the shipyard for the physical installation of the EK80 must be approved by the vessel's national registry and corresponding maritime authority and/or classification society. Such approval must be obtained before the installation can begin. The shipowner and shipyard doing the installation are responsible for obtaining and paying for such approval.*

---

Kongsberg Maritime offers free advice for installation planning. Proposed arrangements may be sent for commentary or suggestions. The following drawings should be submitted should assistance be requested:

- General arrangement
- Body plan and drawings of the relevant compartment
- Lines plan

Relevant outline dimensions and production drawings can be download from our website. Most documents are available in PDF and/or AutoCad (DWG) formats.

- <https://www.kongsberg.com/simrad>

### Related topics

[Preparations, page 43](#)

## Tools, equipment and consumables required for EK80 installation

In order to do the EK80 installation, all necessary tools and equipment for mechanical work, cabinet installation and electrical wiring must be available.

It is not practical to provide a detailed list of all necessary tools and equipment. You must be equipped with a standard set of tools. This tool set must comprise the normal tools for electronic and electromechanical tasks. This includes different screwdriver types, pliers, spanners, a cable stripper, a soldering iron, etc. Each tool must be provided in various sizes. We recommend that all tools are demagnetized to protect your equipment. However, you must make sure that the following specialized tools are available.

- All necessary tools and consumables required for welding
- All necessary tools and consumables required for physical installation of units, cabinets and racks
- All necessary tools and consumables required for electrical installations



**Related topics**[Preparations, page 43](#)

## Personnel qualifications

The installation of the EK80 is a demanding task. It is very important that the personnel involved in the installation tasks are competent and experienced craftsmen.

As a minimum, the following certified craftsmen must be available.

- Naval architects
- Welders
- Electricians
- Project manager

**Note** 

---

*The quality of the welding is critical to the safety of the vessel. Welding must only be done by a certified welder. If applicable, the final installation welds must be approved by the vessel's national registry, the corresponding maritime authority and/or classification society. Observe the relevant rules and regulations related to welding.*

---

**Related topics**[Preparations, page 43](#)

## Where to install the transducer

A single answer to the question "where to install the transducer" cannot be given.

The physical location of the transducer depends on the vessel's design and construction, how the hull is shaped, and how the water runs along the hull. There are however a number of important guidelines, and some of these are even conflicting.

### Note

---

*The information here must be considered as general advice. Each EK80 installation must be handled separately depending on the hull design and the other electrical and mechanical systems installed on the vessel.*

---

### Topics

[Mount the transducer deep, page 48](#)

[Avoid protruding objects near the transducer, page 49](#)

[Mount the transducer at forward part of hull to minimize the effects from the flow boundary water layer, page 50](#)

[Keep the transducer far away from the propellers, page 51](#)

[Mount the transducer at a safe distance from bow thruster\(s\), page 51](#)

[Summary and general recommendations, page 52](#)

## Mount the transducer deep

In order to achieve the best possible EK80 performance, mount the transducer as deep as possible under the vessel's hull.

There are several reasons for this recommendation.

### Flow noise

Consider the situations when the vessel is unloaded, and pitching in heavy seas. The vessel is riding high, and the bow may even be lifted out of the water. This will cause a lot of air to follow the shape of the hull.

The upper water layers of the sea contain a myriad of small air bubbles created by the breaking waves. In heavy seas the upper 5 to 10 metres may be filled with air, and the highest concentrations will be near the surface. Air bubbles absorb and reflect the sound energy, and they may in worst cases block the sound transmission altogether.

### Cavitation

Cavitation is the formation of small air bubbles close to the transducer face. The bubbles appear because the local pressure becomes negative during parts of the acoustic pressure

cycles. The cavitation threshold increases with the hydrostatic pressure. The noise is made when the bubbles implode.

### **Transmitting in air**

The transducer must never be lifted free of the water surface. If the transducer is activated when out of the water it may be damaged beyond repair. Mounting the transducer at a deep position on the hull will normally prevent this.

### **Slamming**

Slamming happens if the vessel hull climbs out of the water in heavy seas. The force of the water when the hull falls down may push the transducer up, and may cause damage both to the transducer and to its mounting. This is especially important for low frequency transducers with large faces. The effect of slamming can be reduced by mounting the transducer as deep as possible on the hull.

### **Note**

---

*Kongsberg Maritime AS takes no responsibility for any damages to the transducer, the cable or the mounting arrangement, caused by slamming.*

---

### **Related topics**

[Where to install the transducer, page 48](#)

[Preparations, page 43](#)

## **Avoid protruding objects near the transducer**

Objects protruding from the hull will generate turbulence and flow noise. This will reduce the EK80 performance.

Protruding objects may be zinc anodes, transducers or even the vessel's keel. Holes and pipe outlets are also important noise sources, as well as rough surfaces caused by bad welding. Even traces of sealing compound, sharp edges, bolts or empty bolt holes will create noise. All these protruding objects may act as resonant cavities amplifying the flow noise at certain frequencies.

Do not place a transducer in the vicinity of protruding objects, and especially not close behind them. Make sure that the surface of the transducer face, the hull plating and putty around the transducer is as even and smooth as possible. Mounting screws or bolts must not be extruding from the transducer, the installation hardware or the hull plating. If necessary, grind and polish all surfaces.

### **Related topics**

[Where to install the transducer, page 48](#)

[Preparations, page 43](#)

## Mount the transducer at forward part of hull to minimize the effects from the flow boundary water layer

The upper water layers of the sea contain a myriad of small air bubbles created by the breaking waves. When the hull moves through water it will cause a disturbance, and this will generate friction. The friction zone is called the *flow boundary layer*.

The flow in this boundary layer may be *laminar* or *turbulent*.

- The *laminar* flow is a nicely ordered, parallel movement of the water.
- The *turbulent* flow is a disorderly flow pattern, full of eddies.

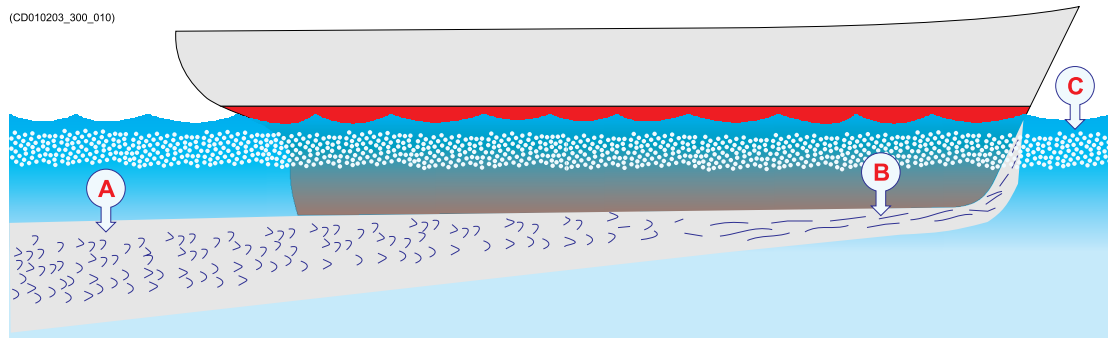

- A *Turbulent flow*  
B *Laminar flow*  
C *Air bubbles*

Air bubbles absorb and reflect the sound energy, and they may in worst cases block the sound transmission altogether.

The boundary layer increases in thickness when it becomes turbulent. The boundary layer is thin in the forward part of the vessel hull, and increases as it moves aft. The thickness depends on ships speed and on the roughness of the hull. All objects sticking out from the hull, or dents in the hull, will disturb the flow and will increase the thickness of the boundary layer. When the flow speed is high, the turbulence can be violent enough to destroy the integrity of the water. Small voids or cavities in the water will occur and this is called cavitation.

It is our experience that a wide and flat bottom, with a rising angle less than around 13 degrees, is prone to giving air problems for the transducer. In any case a transducer location in the forward part of the hull is preferred in order to minimise the influence of the boundary layer.

### Related topics

- [Where to install the transducer, page 48](#)
- [Preparations, page 43](#)

## Keep the transducer far away from the propellers

The propulsion propellers is the dominant noise source on most vessels. The noise is easily transmitted through the water. This noise may often reduce the overall performance of your EK80.

The transducer must be installed as far away from the propellers as possible. The best positions are therefore on the fore part of the hull. Positions outside the direct line of sight from the propellers are best.

On small vessels we recommend mounting the transducer on that side of the keel where the propeller blades move *upwards*. This is because the propeller cavitation is weakest on that side. The cavitation starts when the water flows in the same direction as the propeller blades. This is where the propeller blades move downwards.

### Related topics

[Where to install the transducer, page 48](#)

[Preparations, page 43](#)

## Mount the transducer at a safe distance from bow thruster(s)

Bow thruster propellers are extremely noisy. When you decide where to place the transducer, you must consider the noise created by most bow thrusters.

When in operation, the noise and cavitation bubbles created by the thruster may make your EK80 Wide band scientific echo sounder useless, almost no matter where the transducer is installed. When the bow thrusters are *not* in operation, the tunnel creates turbulence. If your vessel is pitching, the tunnel may be filled with air or aerated water in the upper position and release this in the lower position.

In general, the transducer should therefore be placed well away from the bow thruster(s).

However, this is not an invariable rule. Certain thruster designs - combined with their physical locations on the hull - may still offer a suitable location for the transducer, even close to the thruster. If you are in doubt, consult a naval architect.

### Related topics

[Where to install the transducer, page 48](#)

[Preparations, page 43](#)

## Summary and general recommendations

Some of the installation guidelines provided for transducer location may be conflicting. For this reason, each vessel must be treated individually in order to find the best compromise.

In general, the most important factor is to avoid air bubbles in front of the transducer face. For this reason, the recommended transducer location is normally in the fore part of the hull, well ahead of the noise created by the bow wave.

The maximum distance from the bow is normally equal to one third of the total water line length of the hull.

### Note

*Mounting the transducer more than 10–15 meters from the bow may cause problems with the turbulent flow.*

---

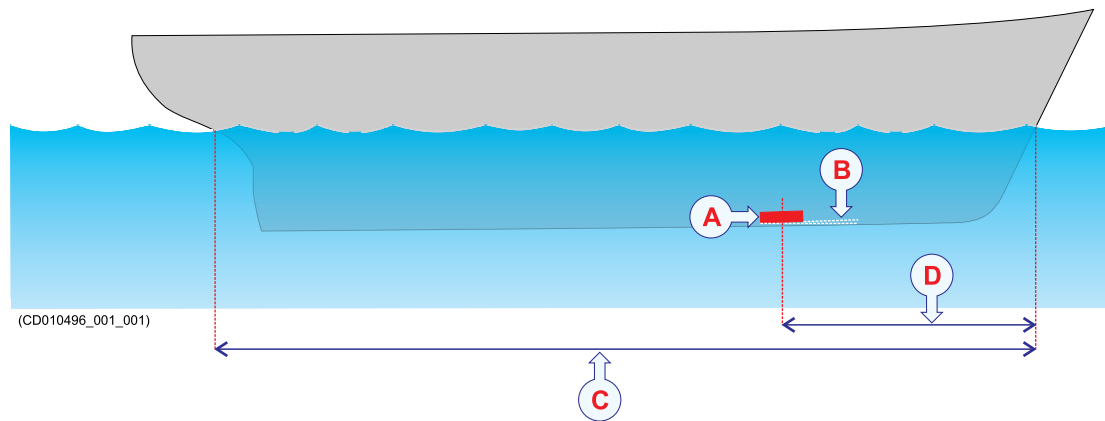

- A** *Transducer*
- B** *Inclination angle*
- C** *Hull length at water line*
- D** *Maximum 1/3 of the hull length at water line (C)*

If the vessel hull has a bulbous bow, this may well be a good transducer location, but also in this case the flow pattern of the aerated water must be taken into consideration. The foremost part of the bulb is often a good location.

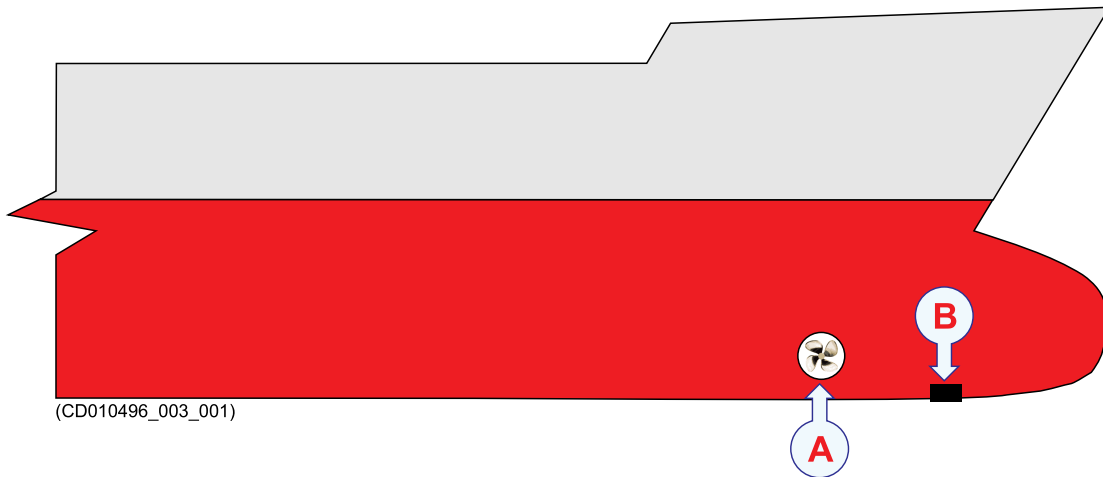

**A** *Thruster*

**B** *Transducer location*

This applies to the vessel in normal trim and speed.

#### Important

The transducer must not have a negative inclination angle compared to water flow.

Do not place a transducer in the vicinity of protruding objects, and especially not close behind them.

Make sure that the surface of the resulting installation is as smooth and streamlined as possible.

#### Related topics

[Where to install the transducer, page 48](#)

[Preparations, page 43](#)

## Acoustic noise

As with any other hydroacoustic systems, the quality of the EK80 echo data and presentations are subject to unwanted acoustic noise. The echoes from any large and small target must be detected inside the noise.

It is important that we keep the noise level as low as possible. This is necessary to obtain long range and dependable interpretations of the echoes. Even with the advanced noise filtering offered by the EK80, we must address the noise challenge. This is important during the planning and preparations for the EK80 installation.

### Topics

[Contributing factors, page 54](#)

[Self noise, page 56](#)

[Ambient noise, page 58](#)

[Fishing gear noise, page 59](#)

[Electrical self noise, page 59](#)

[Some means to reduce acoustic noise, page 59](#)

## Contributing factors

Several factors are contributing to the performance of the hydroacoustic equipment used on board a vessel.

Factors contributing to the performance of the hydroacoustic equipment used on board a vessel are:

- The quality and properties of the transmitted signal
- The quality of the receiving system
- The operational settings made during operation
- The properties of the target(s)
- The signal-to-noise ratio

The majority of these factors can neither be controlled nor improved by means of installation methods or transducer locations. The quality and properties of the transmitting and receiving systems are key factors during our product development, while our end user documentation aims to help the user to make the right filter settings during operation. As for the target properties, there is nothing any of us can do with those.

The *signal-to-noise ratio*, however, can be improved by making the correct choices during installation.

Signal-to-noise ratio (often abbreviated SNR or S/N) is a measure used in science and engineering that compares the level of a desired signal to the level of background noise. It is defined as the ratio of signal power to the noise power, often



expressed in decibels. A ratio higher than 1:1 (greater than 0 dB) indicates more signal than noise. While SNR is commonly quoted for electrical signals, it can be applied to any form of signal [...].

*Wikipedia, Copied September 2013*

The *signal* is the echo that we want to know something about, while the *noise* is any unwanted signals or disturbances. The echo must be detected in the noise and therefore it is necessary to keep the noise level as low as possible in order to obtain high interpretation.

The noise that contributes to the signal to noise ratio may be divided into the following types of noise:

- Self noise
- Ambient noise
- Electrical noise
- Reverberation
- Fishing gear noise

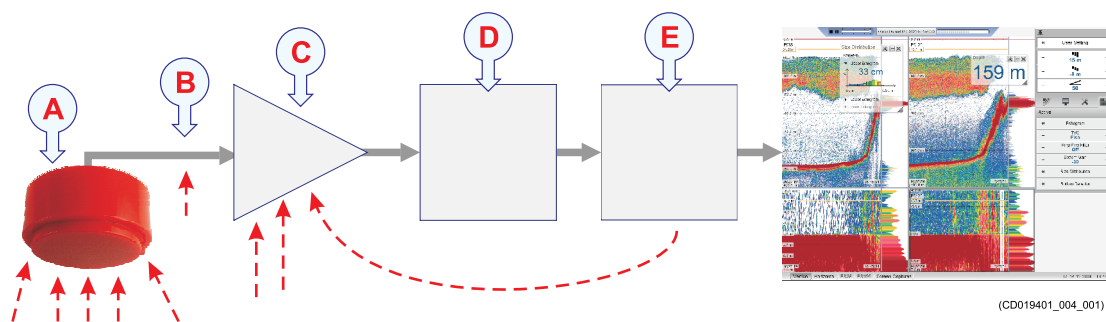

- A** The transducer can pick up noise from
- Biological disturbances
  - Interference
  - Cavitation
  - Propeller noise
  - Flow noise
  - Acoustic noise from other hydroacoustic systems
- B** The transducer cable is long, and may pick up electric noise from generators, pumps, cooling systems and other electric or electromechanical devices.
- C** The preamplifiers are very sensitive, and they can easily pick up electrical noise from internal and external power supplies. The preamplifiers are also vulnerable to analogue noise created by their own electronic circuitry. Digital noise created by the converter and processing circuitry can also create problems.
- D** Converters transform the analogue echoes to digital format.

**E** Signal processing circuitry can create digital noise.

### **Related topics**

[Acoustic noise, page 54](#)

[Preparations, page 43](#)

## **Self noise**

Any vessel equipped with a hydroacoustic system (for example echo sounder or sonar) will produce more or less self noise.

There are many sources of such self noise. We will here go into some details in order to analyse the different sources of self noise on a vessel and how they may influence upon the noise level of the hydroacoustic instruments.

### **Machinery noise**

The main contributor to machinery noise is usually the main engine on board the vessel. The contribution from auxiliary machinery may, however, be considerable, especially if it is in poor shape. The machinery noise can be transmitted to the transducer as:

- Structure-borne noise through the ship structure and the transducer mountings
- Water-borne noise through the hull into the water to the transducer

### **Electrical noise**

Modern vessels are normally equipped with a lot of electric instruments such as hydroacoustic systems, radars, navigation systems, and communication equipment. Any electric instruments may in some cases cause electrical interference and noise. International regulations and certifications are used to control and reduce this, but even these are limited if the electrical systems are poorly installed and/or maintained.

### **Propeller noise**

Propeller noise is often the main source of noise at higher vessel speeds. Variable pitch propellers or fast moving propellers usually make more noise than fixed propellers or slow moving propellers.

Propeller noise is usually water-borne. In some cases, however, shaft vibrations or vibrations in the hull near the propeller may be structure-borne to the transducer. If a propeller blade is damaged, this may increase the noise considerably.

Propeller cavitation is a severe source of noise. "Singing" propellers might be a source of noise, which interferes at discrete frequencies. In some cases static discharge from the rotating propeller shaft may be quite disturbing.

## Cavitation

Cavitation is the formation of small air bubbles close to the transducer face. The bubbles appear because the local pressure becomes negative during parts of the acoustic pressure cycles. The cavitation threshold increases with the hydrostatic pressure. The noise is made when the bubbles implode.



Cavitation noise may appear near extruding objects at higher speeds, but more often it is caused by the propellers. Propeller cavitation is a severe source of noise. The cavitation starts when the water flows in the same direction as the propeller blades. This is where the propeller blades move downwards.

In some cases a resonant phenomenon is set up in a hole near the hull. This sound will have a discrete frequency, while all other flow noise will have a wide frequency spectrum.

(Image from U. S. Navy in the public domain.)

## Flow noise

The upper water layers of the sea contain a myriad of small air bubbles created by the breaking waves. When the hull moves through water it will cause a disturbance, and this will generate friction. The friction zone is called the *flow boundary layer*. The flow in this boundary layer may be *laminar* or *turbulent*.

- The *laminar* flow is a nicely ordered, parallel movement of the water.
- The *turbulent* flow is a disorderly flow pattern, full of eddies.

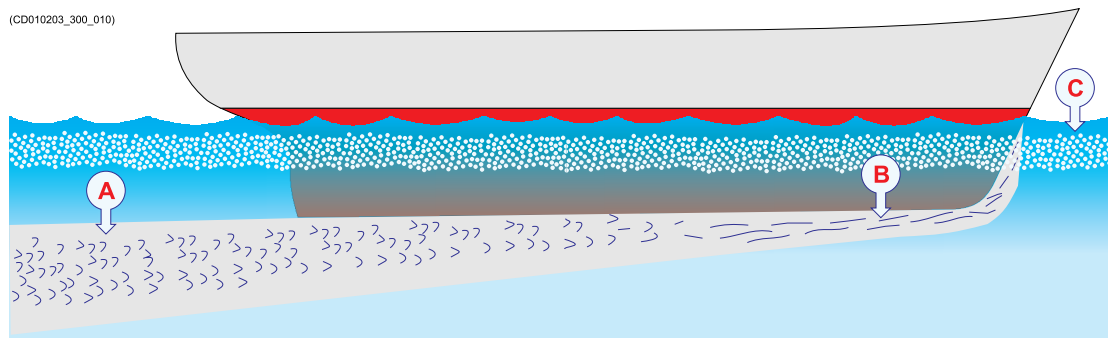

- A *Turbulent flow*  
 B *Laminar flow*  
 C *Air bubbles*

Air bubbles absorb and reflect the sound energy, and they may in worst cases block the sound transmission altogether.

The boundary layer increases in thickness when it becomes turbulent. The boundary layer is thin in the forward part of the vessel hull, and increases as it moves aft. The

thickness depends on ships speed and on the roughness of the hull. All objects sticking out from the hull, or dents in the hull, will disturb the flow and will increase the thickness of the boundary layer. When the flow speed is high, the turbulence can be violent enough to destroy the integrity of the water. Small voids or cavities in the water will occur and this is called cavitation.

### **Rattle noise**

Rattle noise may be caused by loose objects in the vicinity of the transducer, like fixing bolts. The rattle may also come from loose objects inside the hull.

### **Interference**

Interference from other hydroacoustic equipment on board the same vessel may be an annoying source of disturbance. Unless the same frequency is used for more than one piece of equipment only the transmitted pulse will contribute to the interference.

In physics, interference is the phenomenon in which two waves superpose each other to form a resultant wave of greater or lower amplitude. Interference usually refers to the interaction of waves that are correlated or coherent with each other, either because they come from the same source or because they have the same or nearly the same frequency. Interference effects can be observed with all types of waves, for example, light, radio, acoustic, surface water waves or matter waves.

*[https://en.wikipedia.org/wiki/Wave\\_interference](https://en.wikipedia.org/wiki/Wave_interference) — April 2016*

### **Related topics**

[Acoustic noise, page 54](#)

[Preparations, page 43](#)

## **Ambient noise**

Ambient noise is usually not a limiting factor to the performance of sonars and echo sounders.

The ambient noise may be split up as follows:

- **Sea noise:** Air bubbles, seismic disturbances, waves, boundary turbulence, etc.
- **Biological noise:** Fish, mammals
- **Man made noise:** Other vessels, interference
- **Precipitation noise:** Heavy rain or hail

In some areas, where many vessels operate together, the engine and propeller noise from other vessels may be disturbing. Interference from hydroacoustic instruments located in other vessels may also be a limiting factor. The sea noise depends on the weather conditions. In bad weather the sea noise can be quite high due to the waves.

**Related topics**[Acoustic noise, page 54](#)[Preparations, page 43](#)

## Fishing gear noise

Whenever your fishing gear is in use, it will create noise.

A bottom trawl, for instance, is a considerable source of acoustic noise. Still, this noise from the fishing gear will seldom be a limiting factor for hull mounted sonars or echo sounders. However, for operation of a catch monitoring system or a trawl sonar, with the transducer placed on the trawl, the gear noise is one of the main contributors to the noise level.

**Related topics**[Acoustic noise, page 54](#)[Preparations, page 43](#)

## Electrical self noise

Electrical or electronic self noise is picked up or generated in any other part of the equipment than the transducer.

The most common source of electrical self noise is hum. The hum is normally generated by a power supply. It is then picked up by the transducer cables and/or sensitive electronic circuitry. At higher frequencies – where rather wide bandwidths are necessary – the noise from components, transistors or other analogue electronic may be a limiting factor.

**Related topics**[Acoustic noise, page 54](#)[Preparations, page 43](#)

## Some means to reduce acoustic noise

Several factors are contributing to the performance of the hydroacoustic equipment used on board a vessel. Careful planning of the EK80 installation may reduce the acoustic noise.

Unfortunately, it is impossible to simply provide a number of specific procedures to reduce the noise.

An important factor is the physical location of the transducers. This depends on the vessel's design and construction, how the hull is shaped, and how the water runs along the hull. Other factors deal with other equipment mounted on board, and this will also be vessel dependant. At moderate ship speeds the machinery noise is usually dominant. At medium speeds the flow noise increases more rapidly and takes over, while at higher speed the propeller noise will be the main contributor.

Note

---

*The information here must be considered as general advice. Each EK80 installation must be handled separately depending on the hull design and the other electrical and mechanical systems installed on the vessel.*

---

**Reducing flow noise**

- The shape of the transducer (or dome around it) must be as streamlined as possible.
- The hull plating in front of the transducer must be as smooth as possible.

**Important**

---

Be especially aware of bilge keels and zinc alloy anodes. The keel must be rounded off without sharp edges. Neither extruding objects nor abrupt transitions must be present.

---

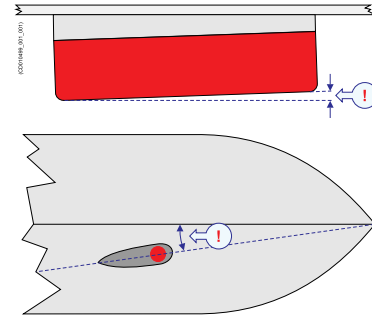

- Each transducer must be mounted with a small inclination angle (approximately 2 degrees).

**Reducing machinery noise**

- Each transducer must be installed as far away from the engine room as possible.
- The main engine and relevant auxiliary engines and equipment must be fixed to rigid foundations to avoid vibrations.
- Any hull structure that may vibrate should be damped or coated to reduce the vibrations.

The use of shock absorbers or floating rafts may sometimes reduce this noise. The structure-borne noise may be reduced by isolation, for example by providing vibration clamping between the transducer and the hull structure.

**Reducing propeller noise**

- Each transducer must be installed as far away from the propellers as possible.
- Sufficient clearance between the propellers and the hull, the rudder and the keel must be provided.
- Place the zinc alloy anodes in places where the water flow is the least disturbed.
- Ensure that the propellers blades are correctly designed and without damages.
- The use of a baffle between the propellers and the transducer may reduce noise appreciably.
- Static discharges caused by the rotating propeller shaft may be removed by proper grounding or by mounting a coal brush from the shaft to vessel ground.

### Reducing rattle noise

Ensure that no parts near the transducers can rattle as a result of water flow or vibrations.

### Reducing interference

Interference from the transmission pulses from other hydroacoustic instruments on board the vessel is difficult to avoid. The problem may be reduced by choosing the working frequencies carefully and to some extent by separating the different transducers. On vessels with a large number of separate hydroacoustic systems installed and in simultaneous use, a separate synchronizing system (for example the K-Sync) should be considered.

### Reducing electrical noise

These points must all be considered to reduce electrical noise on an EK80 system.

- Place the transducer cables in a metal conduit all the way from the transducer to the transceiver. Terminate the conduit as close to the transducer and transceiver as possible.
- Make sure that the transducer cables are completely separated from other cables, boxes, other potential noise sources.
- Make sure that all units are properly grounded.
- Use shielded cables with correct grounding.
- Separate the EK80 cables from other cables with high voltages, large currents or transients. Place all high voltage power cables in metal conduits.
- If you more than one Wide Band Transceiver (WBT), install these in such a way that the transducer cables have the maximum distance to the power and Ethernet cables.
- Ensure maximum physical distance between the Wide Band Transceiver (WBT) and the Power Supply Unit.
- Ensure maximum physical distance between each Power Supply Unit.
- If possible, install the transceivers in a sonar room that is electrically shielded.

### Related topics

[Acoustic noise, page 54](#)

[Preparations, page 43](#)

## Vessel coordinate system

The vessel coordinate system is established to define the relative physical locations of systems and sensors.

When you have several different sensors and transducers on your vessel, and you wish each of them to provide accurate data, you need to know their relative physical positions. The antenna of a position sensor is typically mounted high above the superstructure,

while a motion sensor is located close to the vessel's centre of gravity. Both of these are physically positioned far away from the transducer on a depth sensor, which may be located closer to the bow. Very often, the information from one sensor depends on data from another. It is then important that the relevant measurements are compensated for these relative distances.

*Example*

If you wish to measure the actual water depth, you will need to know the vertical distance from the echo sounder transducer to the water line. Since the vessel's displacement changes with the amount of cargo, fuel etc, the physical location of the water line on the hull must either be measured at a regular basis, or measured with a second sensor.

In order to establish a system to measure the relative distance between sensors, a virtual coordinate system is established. This coordinate system uses three vectors; X, Y and Z.

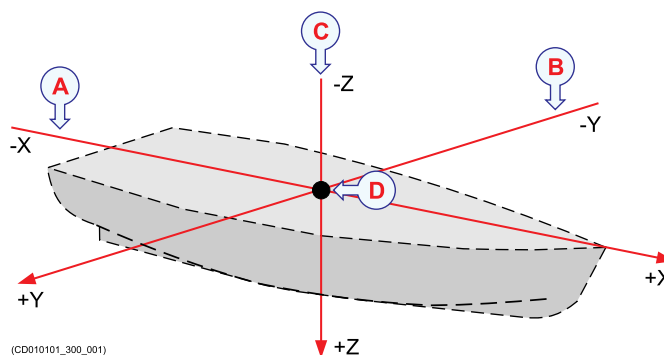

- A** *The X-axis is the longitudinal direction of the vessel, and in parallel with the deck. A positive value for X means that a sensor or a reference point is located ahead of the reference point (origin).*
- B** *The Y-axis is the transverse direction of the vessel, and in parallel with the deck. A positive value for Y means that a sensor or a reference point is located on the starboard side of the reference point (origin).*
- C** *The Z-axis is vertical, and in parallel with the mast. A positive value for Z means that a sensor or a new reference point is located under the reference point (origin).*
- D** *Reference point (Ship Origin)*

**Coordinate system origin**

The *origin* is the common reference point where all three axis in the vessel coordinate system meet. All physical locations of the vessel's sensors (radar and positioning system antennas, echo sounder and sonar transducers, motion reference units, etc.) are referenced to the origin. In most cases, the location of the vessel's "official" origin has been defined by the designer or shipyard. This origin is normally identified with a physical marking, and also shown on the vessel drawings.

Frequently used locations are:

- Aft immediately over the rudder (frame 0)
- Vessel's centre of gravity
- The physical location of the motion reference unit (MRU)



### Coordinate system alternative origins

If necessary, other origin locations may be defined for specific products or purposes. One example is the *Navigation Reference Point* that is frequently used. Whenever a vessel is surveyed to establish accurate offset information, the surveyor may also establish an alternative origin location. Whenever relevant, any such alternative locations must be defined using offset values to the "official" origin established by the designer or shipyard. A commonly used alternative origin is the physical location of the vessel's motion reference unit (MRU).

### Defining the physical location of each sensor

By means of the vessel coordinate system, the physical location of every sensor can be defined using three numerical values for X, Y and Z. These values must define the vertical and horizontal distances from a single reference point; the origin. The physical location of the motion reference unit (MRU) is often the most important sensor to define. For many systems, the vessel heading is also a critical measurement.

#### *Illustration:*

*In this example, a second reference point has been established. It is defined with three positive offset values for X, Y and Z. All values are positive because the new reference point is in front of and below the origin, and on the starboard side.*

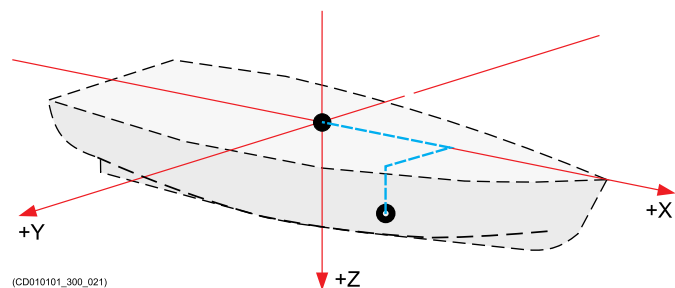

The accuracy of the three numerical values for X, Y and Z defines the accuracy of the sensor data. If you require a high accuracy, for example for underwater positioning, underwater mapping or scientific measurements, you must have each sensor positioned using professional land surveying. For such use, a good alignment survey is critical for high quality results. Surveys are normally done by qualified and trained surveyors using proven survey equipment and methods.

### Related topics

[Preparations, page 43](#)

[Dimensional surveying, page 176](#)

# Installing the EK80 hardware units

## Topics

[Installing the Wide Band Transceiver \(WBT\) using the integrated brackets, page 65](#)

[Installing the Wide Band Transceiver \(WBT\) in a 19" rack, page 67](#)

[Installing the WBT Power Supply, page 69](#)

[Installing the display, page 71](#)

[Installing a commercial computer, page 72](#)

[Installing the Enix Processor Unit, page 74](#)

[Installing the Ethernet switch, page 76](#)

[Mounting the WBT Cabinet, page 78](#)

[Mounting the drawers in the WBT Cabinet, page 81](#)

[Installing the transducer\(s\), page 83](#)

## Installing the Wide Band Transceiver (WBT) using the integrated brackets

The EK80 Wide Band Transceiver (WBT) is normally positioned in a dedicated room in the vicinity of the transducer. The physical length of the cables limit the distance between each transducer and the Wide Band Transceiver (WBT). The Wide Band Transceiver (WBT) can be installed vertically or horizontally using the integrated mounting brackets. Four bolts are used, two on each side.

### Prerequisites

A suitable location for the Wide Band Transceiver (WBT) must be defined prior to installation. It is normally positioned in the sonar room close to the transducer. The unit can in principle be mounted anywhere on board the ship, provided that the location is dry and ventilated.

The length of the transducer cables limits where the Wide Band Transceiver (WBT) can be installed.

You must be equipped with a standard set of tools. This tool set must comprise the normal tools for electronic and electromechanical tasks. This includes different screwdriver types, pliers, spanners, a cable stripper, a soldering iron, etc. Each tool must be provided in various sizes. We recommend that all tools are demagnetized to protect your equipment.

### Context

The unit can be mounted in any direction and on any surface provided that the environmental requirements are met.

#### Note

*If you mount the unit on a bulkhead, position it so that all the sockets are facing down.*



These points must all be considered to reduce electrical noise on an EK80 system.

- If you more than one Wide Band Transceiver (WBT), install these in such a way that the transducer cables have the maximum distance to the power and Ethernet cables.
- Ensure maximum physical distance between the Wide Band Transceiver (WBT) and the Power Supply Unit.
- Ensure maximum physical distance between each Power Supply Unit.
- If possible, install the transceivers in a sonar room that is electrically shielded.
- Make sure that all units are properly grounded.

### Procedure

- 1 Prepare the location and the necessary tools.

- 2 Observe the installation requirements.
  - a Depending on the local requirements and preferences, the Wide Band Transceiver (WBT) can be installed on the bulkhead, inside a console, in a cabinet or 19” rack, or on a desk.
  - b The position must be chosen to fit the available cable lengths between the Wide Band Transceiver (WBT) and the other units it connects to. Short distance to the transducer is always first priority.
  - c If you placing the Wide Band Transceiver (WBT) on the bridge, observe the compass safe distance.
  - d Make sure that enough space is made available for maintenance purposes.
  - e Make sure that adequate ventilation is available to avoid overheating.
  - f Make sure that the installation method allows for the physical vibration, movements and forces normally experienced on a vessel.

Note

---

*In order to allow for future maintenance, we recommend to mount the unit with its cables and connectors available for easy access.*

---

- 3 Make sure that the chosen location meets the installation requirements.
- 4 Place the Wide Band Transceiver (WBT) in the selected position.
- 5 Secure the unit using four 5 mm bolts.
- 6 Connect the cables.

Note

---

*When you connect the cables, make sure that they are all properly secured, and able to withstand the vibration and movements of the vessel.*

---

**Related topics**

[Installing the EK80 hardware units, page 64](#)

[388697 Wide Band Transceiver \(WBT\) outline dimensions, page 308](#)

[Equipment handling, page 320](#)

[Compass safe distance, page 301](#)

## Installing the Wide Band Transceiver (WBT) in a 19" rack

The Wide Band Transceiver (WBT) can be installed in a 19-inch rack by means of an optional drawer. You will need one drawer for each Wide Band Transceiver (WBT) unit.

### Prerequisites

It is assumed that a suitable 19-inch rack has already been installed.

You must be equipped with a standard set of tools. This tool set must comprise the normal tools for electronic and electromechanical tasks. This includes different screwdriver types, pliers, spanners, a cable stripper, a soldering iron, etc. Each tool must be provided in various sizes. We recommend that all tools are demagnetized to protect your equipment.

### Context

Each transceiver must be installed on a dedicated drawer in the rack.

- A** *Mounting bolts for the Wide Band Transceiver (WBT)*
- B** *Mounting bracket (not used)*
- C** *Holes for fastening and securing the cables*
- D** *Mounting bolts for the drawer assembly*
- E** *Mounting bolts for the drawer*

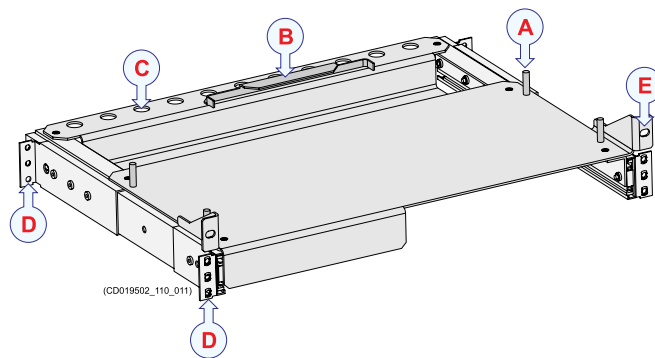

### Note

*Ensure maximum physical distance between the Wide Band Transceiver (WBT) and the Power Supply Unit. This is important to reduce noise. Place the power supplies on a dedicated drawer at the bottom of the cabinet.*

*Make sure that all units are properly grounded.*

If your EK80 comprises more than one Wide Band Transceiver (WBT), you can use the optional WBT Cabinet. This 19" rack holds maximum seven transceivers with power supplies, as well as an Ethernet switch and a power distribution panel.

### Procedure

- 1 Prepare the location and the necessary tools.
- 2 Observe the installation requirements.

- a Depending on the local requirements and preferences, the Wide Band Transceiver (WBT) can be installed on the bulkhead, inside a console, in a cabinet or 19" rack, or on a desk.
- b The position must be chosen to fit the available cable lengths between the Wide Band Transceiver (WBT) and the other units it connects to. Short distance to the transducer is always first priority.
- c Observe the compass safe distance.
- d Make sure that enough space is made available for maintenance purposes.
- e Make sure that adequate ventilation is available to avoid overheating.
- f Make sure that the installation method allows for the physical vibration, movements and forces normally experienced on a vessel.

**Note** \_\_\_\_\_

*In order to allow for future maintenance, we recommend to mount the unit with its cables and connectors available for easy access.*

---

- 3 Make sure that the chosen location meets the installation requirements.
- 4 Place the Wide Band Transceiver (WBT) on the WBT Drawer.
- 5 Mount the transceiver and the power supply using the brackets, bolts and nuts provided.
- 6 Mount the WBT Drawer into the 19-inch rack.
- 7 Connect the cables.

**Note** \_\_\_\_\_

*When you connect the cables, make sure that they are all properly secured, and able to withstand the vibration and movements of the vessel.*

---

**Related topics**

[Installing the EK80 hardware units, page 64](#)

[388697 Wide Band Transceiver \(WBT\) outline dimensions, page 308](#)

[Equipment handling, page 320](#)

[Compass safe distance, page 301](#)

## Installing the WBT Power Supply

The power supply provided with the Wide Band Transceiver (WBT) is a commercial type custom made for the EK80. A dedicated installation procedure is provided.

### Prerequisites

A suitable location for the power supply must be defined prior to installation. If you place the unit on the bridge, observe the compass safe distance.

You must be equipped with a standard set of tools. This tool set must comprise the normal tools for electronic and electromechanical tasks. This includes different screwdriver types, pliers, spanners, a cable stripper, a soldering iron, etc. Each tool must be provided in various sizes. We recommend that all tools are demagnetized to protect your equipment.

### Context

The power supply can be installed in many ways.

- You can mount it on a desktop using the brackets provided with the unit.
- You can mount it on a bulkhead using the optional wall bracket.
- You can mount it using any means available.



These points must all be considered to reduce electrical noise on an EK80 system.

- If you more than one Wide Band Transceiver (WBT), install these in such a way that the transducer cables have the maximum distance to the power and Ethernet cables.
- Ensure maximum physical distance between the Wide Band Transceiver (WBT) and the Power Supply Unit.
- Ensure maximum physical distance between each Power Supply Unit.
- If possible, install the transceivers in a sonar room that is electrically shielded.
- Make sure that all units are properly grounded.

### Procedure

- 1 Find a suitable location for the power supply.
- 2 Prepare the location and the necessary tools.
- 3 Observe the installation requirements.
  - a The chosen position must fit the available cable lengths between the power supply, the transceiver and the AC mains power outlet.
  - b If you place the unit on the bridge, observe the compass safe distance.

- c Make sure that enough space is made available for maintenance purposes.
- d Make sure that adequate ventilation is available to avoid overheating.
- e Make sure that the installation method allows for the physical vibration, movements and forces normally experienced on a vessel.

**Note** \_\_\_\_\_

*In order to allow for future maintenance, we recommend to mount the unit with its cables and connectors available for easy access.*

---

- 4 Make sure that the chosen location meets the installation requirements.
- 5 Bulkhead installation
  - a Mount the wall bracket using suitable bolts or screws.
  - b Place the power supply in the bracket so that the small lamp is visible.
- 6 Desktop installation
  - a Place the unit in a suitable location.
  - b Position and fasten the unit using the bracket and the mounting screws.
- 7 "Ad hoc" installation
  - a Place the unit in a suitable location (horizontally or vertically).
  - b Position and fasten the unit using any means available.
- 8 Connect the cables.

**Note** \_\_\_\_\_

*When you connect the cables, make sure that they are all properly secured, and able to withstand the vibration and movements of the vessel.*

---

**Related topics**

[Installing the EK80 hardware units, page 64](#)

[388697 Wide Band Transceiver \(WBT\) outline dimensions, page 308](#)

[Equipment handling, page 320](#)

[Compass safe distance, page 301](#)



## Installing the display

A display is a required part of the EK80 Wide band scientific echo sounder. For best readability, the display must be protected from glare and have the correct height and angle. The display is normally not included with the EK80 delivery. A generic procedure is provided.

### Prerequisites

You must be equipped with a standard set of tools. This tool set must comprise the normal tools for electronic and electromechanical tasks. This includes different screwdriver types, pliers, spanners, a cable stripper, a soldering iron, etc. Each tool must be provided in various sizes. We recommend that all tools are demagnetized to protect your equipment.

A suitable location for the display must be defined prior to installation. If you place the unit on the bridge, observe the compass safe distance.

### Procedure

- 1 Prepare the location and the necessary tools.
- 2 Observe the installation requirements.
  - a Check the installation requirements provided by the manufacturer.
  - b Position the display so that it is best protected from glare which reduces readability.
  - c Observe the compass safe distance.
  - d Make sure that enough space is made available for maintenance purposes.
  - e Make sure that adequate ventilation is available to avoid overheating.
  - f Make sure that the installation method allows for the physical vibration, movements and forces normally experienced on a vessel.

#### Note

---

*In order to allow for future maintenance, we recommend to mount the unit with its cables and connectors available for easy access.*

---

- 3 Make sure that the chosen location meets the installation requirements.
- 4 Install the display as described in the applicable documentation provided by the manufacturer.
- 5 Connect the cables.

#### Note

---

*When you connect the cables, make sure that they are all properly secured, and able to withstand the vibration and movements of the vessel.*

---

### Related topics

[Installing the EK80 hardware units, page 64](#)

[Equipment handling, page 320](#)

[Compass safe distance, page 301](#)

## Installing a commercial computer

The Processor Unit can be installed inside a console, inside a suitable cabinet, in a 19" rack or on a desk. Make sure that adequate ventilation is available to avoid overheating.

### Prerequisites

You must be equipped with a standard set of tools. This tool set must comprise the normal tools for electronic and electromechanical tasks. This includes different screwdriver types, pliers, spanners, a cable stripper, a soldering iron, etc. Each tool must be provided in various sizes. We recommend that all tools are demagnetized to protect your equipment.

A suitable location for the computer must be defined prior to installation. Observe the compass safe distance.

### Context

For installation of a commercial computer, refer to the manual supplied by the manufacturer.

### Note

---

*Make sure that the chosen computer meets the EK80 requirements. The design and construction must allow for marine use, and the computer must be able to withstand the movements and vibrations normally experienced on a vessel. Verify that you have easy access to cables and connectors, and that the computer can be installed in a safe and secure way.*

*Standard office computers may not be well fitted for maritime use. The motions and vibrations experienced on a vessel may reduce the computer lifetime considerably. While installing a commercial computer, use your common sense to improve the installation method suggested by the manufacturer.*

---

### Procedure

- 1 Prepare the location and the necessary tools.
- 2 Observe the installation requirements.
  - a Depending on its physical properties, install the computer inside a console, in a cabinet or 19" rack, or on a desk.
  - b Choose a position to fit the available cable lengths between the computer and the other units it connects to.

- c Observe the compass safe distance.
- d Make sure that enough space is made available for maintenance purposes.
- e Make sure that adequate ventilation is available to avoid overheating.
- f Make sure that the installation method allows for the physical vibration, movements and forces normally experienced on a vessel.

**Note** \_\_\_\_\_

*In order to allow for future maintenance, we recommend to mount the unit with its cables and connectors available for easy access.*

---

- 3 Make sure that the chosen location meets the installation requirements.

- 4 Provide ample space around the computer.

You must be able to reach and use the front and rear mounted connectors and devices. It is also important that you allow for easy access to all the cables, and enough space for inspection, maintenance and parts replacement. If relevant, make sure that the space allows you to open the computer for unobstructed access to its internal parts.

**Note** \_\_\_\_\_

*Make sure that you can access both the rear and front side of the computer after it has been installed.*

---

- 5 Install the computer.

Observe the applicable documentation provided by the manufacturer.

- 6 Connect the cables.

**Note** \_\_\_\_\_

*When you connect the cables, make sure that they are all properly secured, and able to withstand the vibration and movements of the vessel.*

---

**Related topics**

[Installing the EK80 hardware units, page 64](#)

[Equipment handling, page 320](#)

[Compass safe distance, page 301](#)

## Installing the Enix Processor Unit

The Processor Unit can be installed inside a console, inside a suitable cabinet, in a 19" rack or on a desk. When mounted on a horizontal foundation, for example inside a cabinet, rack or console, use the bottom plate with the two base rails. These are fitted with shock absorbers.

### Prerequisites

You must be equipped with a standard set of tools. This tool set must comprise the normal tools for electronic and electromechanical tasks. This includes different screwdriver types, pliers, spanners, a cable stripper, a soldering iron, etc. Each tool must be provided in various sizes. We recommend that all tools are demagnetized to protect your equipment.

A suitable location for the Processor Unit must be defined prior to installation. Observe the compass safe distance.

- A** *The bottom plate is mounted with six bolts through the computer chassis.*
- B** *Each rail provides two holes for mounting to a flat surface.*
- C** *Remove this bolt to release the rail from the bottom plate.*

### Context

If you intend to mount the Enix Processor Unit in a 19" rack, you can disregard this procedure. However, you may then wish to remove the bottom plate and shock absorbers as described in this procedure, as these will not be required.

### Procedure

- 1 Prepare the location and the necessary tools.
- 2 Observe the installation requirements.
  - a Depending on its physical properties, install the computer inside a console, in a cabinet or 19" rack, or on a desk.
  - b Choose a position to fit the available cable lengths between the computer and the other units it connects to.
  - c Observe the compass safe distance.
  - d Make sure that enough space is made available for maintenance purposes.
  - e Make sure that adequate ventilation is available to avoid overheating.
  - f Make sure that the installation method allows for the physical vibration, movements and forces normally experienced on a vessel.

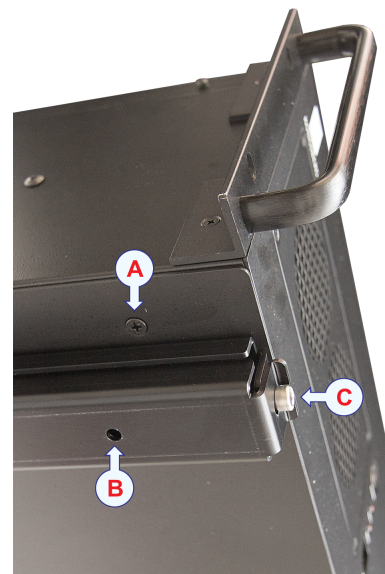

Note

---

*In order to allow for future maintenance, we recommend to mount the unit with its cables and connectors available for easy access.*

---

- 3 Make sure that the chosen location meets the installation requirements.
- 4 Provide ample space around the computer.

You must be able to reach and use the front and rear mounted connectors and on/off switches. It is also important that you allow for easy access to all the cables, and enough space for inspection, maintenance and parts replacement. If relevant, make sure that the space allows you to open the computer for unobstructed access to its internal parts.

Note

---

*Make sure that you can access both the rear and front side of the computer after it has been installed.*

---

- 5 Install the computer.
  - a Turn the Processor Unit cabinet upside down, and remove the bottom plate (A) with the shock absorbers.
  - b Observe the four holes in the shock absorbers and the bottom plate (B).
  - c Using the bottom plate as a template, mark the position of the mounting bolts on the foundation.
  - d Mount the bottom plate back on the Processor Unit cabinet.
  - e Disassemble the two base rails from the Processor Unit by removing the two front Allen bolts (C).
  - f Remove the bolts, lift the Processor Unit up and forward.
  - g Mount the two base rails on the foundation.
  - h Place the Processor Unit onto the rails at their rear end.
  - i Press it down.
  - j Secure the Processor Unit with the two front Allen bolts (C).
- 6 Connect the cables.

Note

---

*When you connect the cables, make sure that they are all properly secured, and able to withstand the vibration and movements of the vessel.*

---

### Related topics

- [Installing the EK80 hardware units, page 64](#)
- [385609 Processor Unit dimensions, page 310](#)
- [Equipment handling, page 320](#)
- [Compass safe distance, page 301](#)

## Installing the Ethernet switch

If you use more than one Wide Band Transceiver (WBT), a high capacity Ethernet switch is required. The Ethernet switch is used to connect each Wide Band Transceiver (WBT) to the Processor Unit.

### Prerequisites

You must be equipped with a standard set of tools. This tool set must comprise the normal tools for electronic and electromechanical tasks. This includes different screwdriver types, pliers, spanners, a cable stripper, a soldering iron, etc. Each tool must be provided in various sizes. We recommend that all tools are demagnetized to protect your equipment.

A suitable location for Ethernet switch must be defined prior to installation. If you place the unit on the bridge, observe the compass safe distance.

### Procedure

- 1 Prepare the location and the necessary tools.
- 2 Observe the installation requirements.
  - a Check the installation requirements provided by the manufacturer.
  - b Observe the compass safe distance.
  - c Make sure that enough space is made available for maintenance purposes.
  - d Make sure that the installation method allows for the physical vibration, movements and forces normally experienced on a vessel.

#### Note

---

*In order to allow for future maintenance, we recommend to mount the unit with its cables and connectors available for easy access.*

---

- 3 Make sure that the chosen location meets the installation requirements.
- 4 Mount the Ethernet switch as recommended by the manufacturer.

- 5 Connect the cables.

**Note**

---

*When you connect the cables, make sure that they are all properly secured, and able to withstand the vibration and movements of the vessel.*

---

**Related topics**

[Installing the EK80 hardware units, page 64](#)

[Equipment handling, page 320](#)

[Compass safe distance, page 301](#)

## Mounting the WBT Cabinet

The WBT Cabinet is a customized 19"-inch instrument rack fitted with powerful shock absorbers. The cabinet can contain maximum seven custom drawers, and each of these will hold one Wide Band Transceiver (WBT) and its power supply. An Ethernet switch and a power distributor panel are included the bottom of the cabinet.

### Prerequisites

You must be equipped with a standard set of tools. This tool set must comprise the normal tools for electronic and electromechanical tasks. This includes different screwdriver types, pliers, spanners, a cable stripper, a soldering iron, etc. Each tool must be provided in various sizes. We recommend that all tools are demagnetized to protect your equipment. The following specific tools are required for this task:

- Power drill
- Welding equipment

We recommend that you install the WBT Cabinet before you install the WBT Drawers and the transceivers.

*Illustration:*

*Use bulkhead support bracket(s) to make installation easier. Place the cabinet on "U"-shaped steel profiles to make more room for the cables.*

### Context

The cabinet is installed using shock absorbers. It is mounted on the deck and secured against a bulkhead. Alternatively, you can place it next to other similar cabinets, and use these for support.

Place the cabinet on "U"-shaped steel profiles to make more room for the cables. Design and install suitable mounting brackets if it is necessary to obtain additional distance from the bulkhead.

The installation of the cabinet must be planned and prepared by the installation shipyard in close cooperation with the end user. Relevant installation drawings with mounting details must be provided by the shipyard.

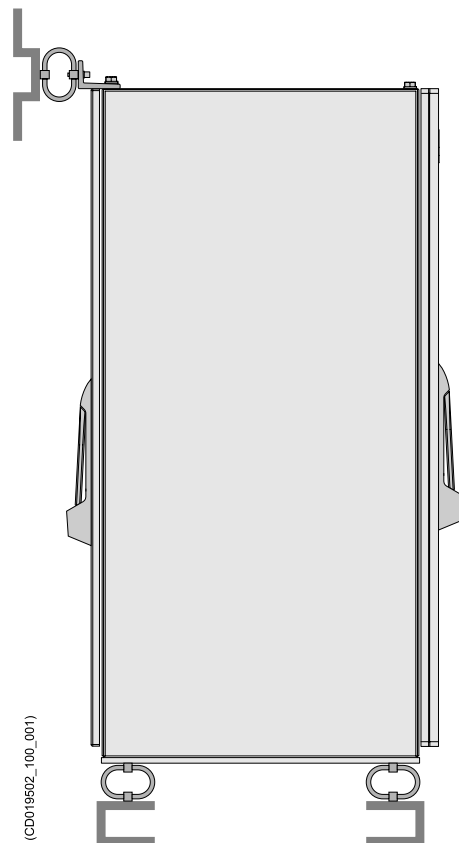



**Caution**

---

Before welding commences, make sure that the room is properly ventilated. Always wear the personal protective equipment. Observe and obey the relevant safety instructions.

---

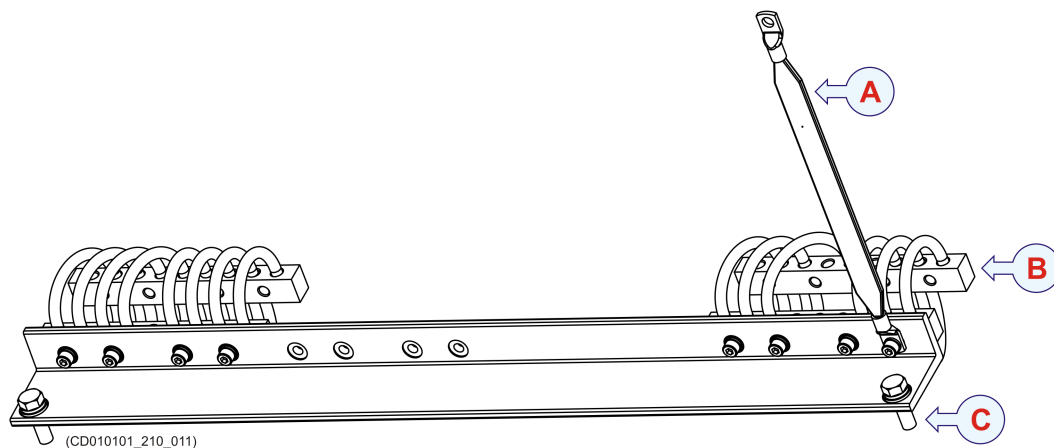

- A** Earth strap
- B** Bolt the shock absorber to the bulkhead.
- C** Secure the shock absorber assembly to the top of the cabinet.

Cable entry is found at the top and/or bottom of the cabinet.

**Note**

---

Ensure maximum physical distance between the Wide Band Transceiver (WBT) and the Power Supply Unit. This is important to reduce noise. Place the power supplies on a dedicated drawer at the bottom of the cabinet.

How to install the cables in the WBT Cabinet is described on drawing 444425. The drawing can be downloaded from our website. The drawing is also included on the EK80 USB.

---

**Procedure**

- 1 Prepare the installation of the cabinet.
  - a Observe the outline dimensions drawing.

The drawing is located in the *Drawing file* chapter in this manual. It can also be downloaded from our website.

- <https://www.kongsberg.com/simrad>

Note

---

*The outline dimensions drawing shows the initial size of an empty cabinet. When the cabinet is completed for normal operation, the weight will compress the bottom shock absorbers slightly. You must take this into consideration when you plan the mounting.*

---

- b Determine the location of the unit.
- c Verify that the location meets the sonar room requirements
- d Verify that the location meets the environmental requirements defined for the EK80.
- e Verify that the location is within range of the transducer cables.
- f Make sure that the location offers ample space around the cabinet to allow for cables, maintenance and parts replacement.
- g Determine the installation method.
- h Make all necessary installation drawings.
- i If relevant, design and manufacture bulkhead support bracket(s) and/or "U" shaped steel profiles.

Note

---

*The use of "U" shaped profiles and bulkhead support bracket(s) is optional.*

---

- 2 Mount the "U" shaped profiles.
  - a Design, manufacture and mount the U-shaped steel profiles.
  - b Make sure that the profiles can withstand the full weight of the cabinet.
  - c Make the required mounting holes to accept the bottom frame (with shock absorbers).
  - d Position the profiles on the deck, and mount them using bolts or welds.
- 3 Mount the bottom frame.

The bottom frame is fitted with four shock absorbers. If you have used U-shaped profiles, place the frame on top of these.
- 4 Mount the bulkhead support bracket.
  - a Design and manufacture the bulkhead bracket.
  - b Make the required mounting holes to accept the top shock absorbers.
  - c Position the brackets on the bulkhead, and mount them using bolts or welds.

- 5 Mount the top shock absorber assembly.
  - a Remove the four lifting lugs.
  - b Mount the top shock absorber assembly using two of the same holes.
  - c Use spare bolts to close the remaining lifting lug holes.
- 6 Place cabinet in its correct position on the bottom frame.
  - a Use four bolts through the bottom frame to secure the cabinet.
  - b Mount the top shock absorbers to the bulkhead support bracket(s).
- 7 Fasten the earth strap.

### **Related topics**

[Installing the EK80 hardware units, page 64](#)

[400930 WBT Cabinet outline dimensions, page 314](#)

[Equipment handling, page 320](#)

[Compass safe distance, page 301](#)

## **Mounting the drawers in the WBT Cabinet**

The WBT Cabinet can contain maximum seven custom drawers. Each drawer will hold one Wide Band Transceiver (WBT) and its power supply. The drawer is mounted in the same way as any other equipment designed for 19" racks using standard tools.

### **Prerequisites**

You must be equipped with a standard set of tools. This tool set must comprise the normal tools for electronic and electromechanical tasks. This includes different screwdriver types, pliers, spanners, a cable stripper, a soldering iron, etc. Each tool must be provided in various sizes. We recommend that all tools are demagnetized to protect your equipment.

### **Context**

We recommend that you mount all the empty drawers into the WBT Cabinet before you mount the Wide Band Transceiver (WBT) unit on each drawer.

- A** Mounting bolts for the Wide Band Transceiver (WBT)
- B** Mounting bracket (not used)
- C** Holes for fastening and securing the cables
- D** Mounting bolts for the drawer assembly
- E** Mounting bolts for the drawer

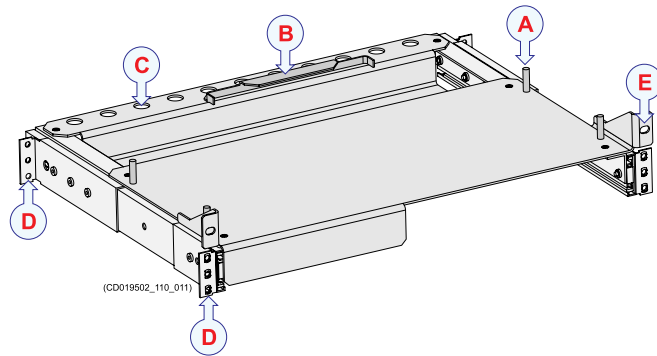

**Note**

Ensure maximum physical distance between the Wide Band Transceiver (WBT) and the Power Supply Unit. This is important to reduce noise. Place the power supplies on a dedicated drawer at the bottom of the cabinet.

How to install the cables in the WBT Cabinet is described on drawing 444425. The drawing can be downloaded from our website. The drawing is also included on the EK80 USB.

---

**Procedure**

- 1 Decide where in the cabinet you wish to mount the drawers.
- 2 Mount each drawer using six bolts on each side (**D**).
- 3 Pull out the drawer.
- 4 Remove the bracket (**B**).
- 5 Mount the Wide Band Transceiver (WBT) using the bolts provided (**A**).

**Related topics**

- [Installing the EK80 hardware units, page 64](#)
- [400930 WBT Cabinet outline dimensions, page 314](#)
- [Equipment handling, page 320](#)
- [Compass safe distance, page 301](#)

## Installing the transducer(s)

The installation of the transducer (or transducers) is a key task for successful use of the EK80 Wide band scientific echo sounder. Not only will you need to penetrate the vessel's hull, you must also to select a physical location for maximum performance and minimum acoustic and electric noise.

### Prerequisites

To get a full overview of the installation, you need all relevant vessel drawings. You also need the drawings provided for each transducer.

### Context

Necessary information for the installation of each transducer can be found in the end-user documentation provided with the transducer.

End user manuals and source drawings (normally in AutoCad format) can be downloaded from our website.

- <https://www.kongsberg.com/td>

### Procedure

- 1 Determine the physical location of the transducer.  
The decision must be based on:
  - The vessel drawings
  - The shape and properties of the hullMake sure that all possible considerations are made to reduce noise.
- 2 Based on the shape of the transducer housing, and the mounting devices available, determine the installation method.
- 3 Design, manufacture and mount the necessary fairing, installation blister, keel box and/or tank that is required to mount the transducer.
- 4 Design, manufacture and mount the steel conduit for the transducer cable.
- 5 Unpack the transducer from its transport crate.
- 6 Position the transducer under the mounting location.
- 7 Pull the transducer cable up through the steel conduit.
- 8 Tighten the packing nipple on the cable gland properly to avoid leaks.
- 9 Mount the transducer.
- 10 Seal the top of the steel conduit to prevent water leaks.
- 11 Connect the transducer cable to the Wide Band Transceiver (WBT).
- 12 If your vessel will operate in waters with a lot of marine growth, consider applying a thin layer of anti-fouling paint to the transducer face.

**Related topics**

[Installing the EK80 hardware units, page 64](#)

[Equipment handling, page 320](#)

[Compass safe distance, page 301](#)

# Cable layout and interconnections

## Topics

[Read this first, page 86](#)

[Reducing electrical noise, page 86](#)

[Cable plans, page 88](#)

[List of EK80 cables, page 94](#)

[Installing the EK80 cables, page 97](#)

[Connections to specific hardware items, page 110](#)

[Setting up the EK80 in a synchronized system, page 126](#)

[Cable drawings and specifications, page 136](#)

[Basic cable requirements, page 167](#)

## Read this first

Detailed information about cable specifications, termination and connectors is provided. Unless otherwise specified, all cables are supplied by Kongsberg Maritime as a part of the EK80 delivery.

Detailed drawings are provided for relevant cables. Each drawing provides additional information, and may, when applicable, include minimum specifications, connector terminations and the required number of cores. Drawings are generally not provided for standard commercial cables. Cables fall into three categories.

- 1 **System cables:** These cables are provided by Kongsberg Maritime as a part of the EK80 delivery.
- 2 **Shipyard cables:** These cables must be provided by the shipyard performing the installation, or the shipowner. It is very important that the cables used meet the minimum specifications provided in this manual.
- 3 **Commercial cables:** These cables may be provided by Kongsberg Maritime as a part of the EK80 delivery. They may also be included with third party items that are used with the EK80.

All electronic installations and corresponding wiring must be in accordance with the vessel's national registry and corresponding maritime authority and/or classification society.

### Note

---

*It is very important that all cables are properly installed and correctly terminated. Observe the relevant regulations and work standards. Always leave enough cable slack close to system units and cabinets to allow for maintenance.*

*Only skilled and authorized personnel can install the EK80 cables.*

*Kongsberg Maritime accepts no responsibility for damage to the system, or reduced operational performance, when this is caused by improper wiring.*

*Before you install or maintain the EK80 cables, make sure that the AC mains circuit breaker for the system is switched off.*

---

## Reducing electrical noise

These points must all be considered to reduce electrical noise on an EK80 system.

### Note

---

*The information here must be considered as general advice.*

---



- Place the transducer cables in a metal conduit all the way from the transducer to the transceiver. Terminate the conduit as close to the transducer and transceiver as possible.
- Make sure that the transducer cables are completely separated from other cables, boxes, other potential noise sources.
- Make sure that all units are properly grounded.
- Use shielded cables with correct grounding.
- Separate the EK80 cables from other cables with high voltages, large currents or transients. Place all high voltage power cables in metal conduits.
- If you more than one Wide Band Transceiver (WBT), install these in such a way that the transducer cables have the maximum distance to the power and Ethernet cables.
- Ensure maximum physical distance between the Wide Band Transceiver (WBT) and the Power Supply Unit.
- Ensure maximum physical distance between each Power Supply Unit.
- If possible, install the transceivers in a sonar room that is electrically shielded.

## Cable plans

### Topics

[About the cable plans, page 88](#)

[Topside cable plan, page 89](#)

[Sonar room cable plan with one transceiver, page 90](#)

[Sonar room cable plan with two transceivers, page 91](#)

[Sonar room cable plan with WBT Cabinet, page 92](#)

[EC150-3C cable plan, page 93](#)

### About the cable plans

Due to its modular design, the EK80 system can be set up in a variety of configurations to suit individual needs for operational frequencies, transducers and functionality. It is not practical to define specific cable plans for all these configurations.

To illustrate the variety of configurations, the following basic cable plans are provided.

- Standard topside setup with the Processor Unit
- Standard transceiver setup with one Wide Band Transceiver (WBT) unit.
- Standard transceiver setup with two Wide Band Transceiver (WBT) units.
- Standard transceiver setup with a WBT Cabinet.
- Standard transceiver setup with EC150-3C units for acoustic Doppler current profiler (ADCP) functionality.

The Wide Band Transceiver (WBT) used by the Simrad EK80 can be set up to work with maximum four -4- operational frequencies. This means that you can use four single frequency/single beam transducers, two dual frequency transducers, or one split beam transducer.

In order to take advantage of the advanced functionality provided by the EK80 (size distribution, fish position and echo position), it is normally set up with split beam transducers. This means that one Wide Band Transceiver (WBT) is required for each channel. In this context, the phrase *channel* is used as a common term to identify the combination of transceiver, transducer and operating frequency.

### Related topics

[Cable plans, page 88](#)

[Cable layout and interconnections, page 85](#)

## Topside cable plan

The topside/bridge cables include those used to connect the EK80 Processor Unit and the display to each other, to AC mains power, and to external devices. One high capacity Ethernet cable connects the Processor Unit to the Wide Band Transceiver (WBT).

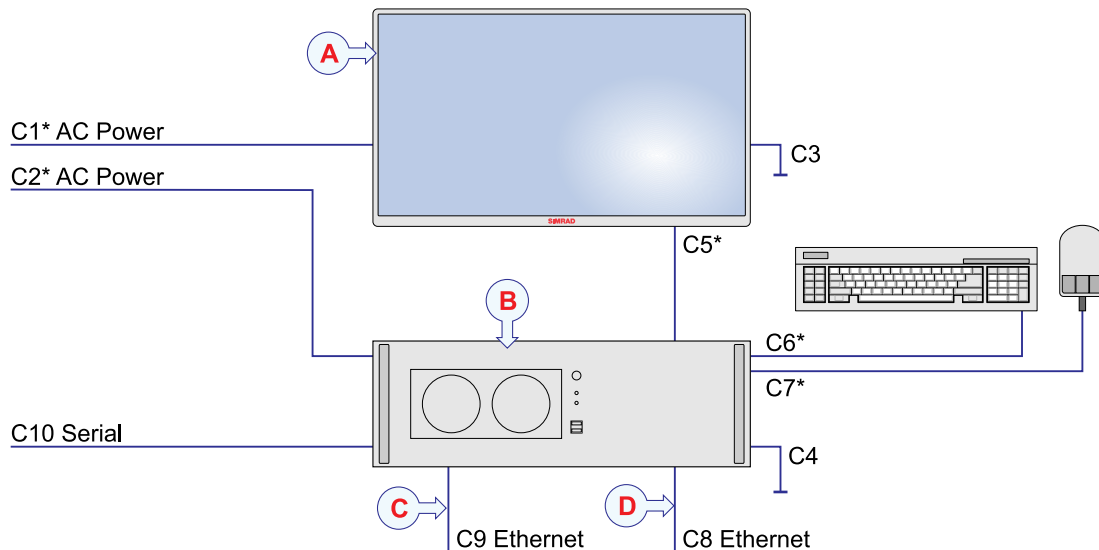

- A *Display (You can use more than one display on your EK80 Processor Unit depending on personal and/or operational preferences.)*
- B *Processor Unit*
- C *One Ethernet cable connects the Processor Unit to the local area network (LAN).*
- D *One high capacity Ethernet cable connects the Processor Unit to the Wide Band Transceiver (WBT).*

Cables identified with an asterisk (\*) are system or commercial cables. These cables are provided with the EK80 delivery or the relevant item.

It is very important that high-quality Ethernet cables are used. You must use CAT-5E STP (Shielded Twisted Pair) quality or better. If you use cables with lower bandwidth capacity you will reduce the EK80 performance. Do not connect the Processor Unit to the Wide Band Transceiver (WBT) using an existing local area network (LAN).

### Tip

*Even though only one Ethernet cable is used, we recommend that you install two cables between the Processor Unit and the Wide Band Transceiver (WBT).*

More than one serial line cable may be required to connect the Processor Unit to external devices. To identify these cables, use postfix letters. (C10A, C10B, C10C...).

### Related topics

[Cable plans, page 88](#)

[Cable layout and interconnections, page 85](#)

## Sonar room cable plan with one transceiver

The Wide Band Transceiver (WBT) cables include those used to connect the EK80 transceiver(s) to AC mains power, and to the transducer(s).

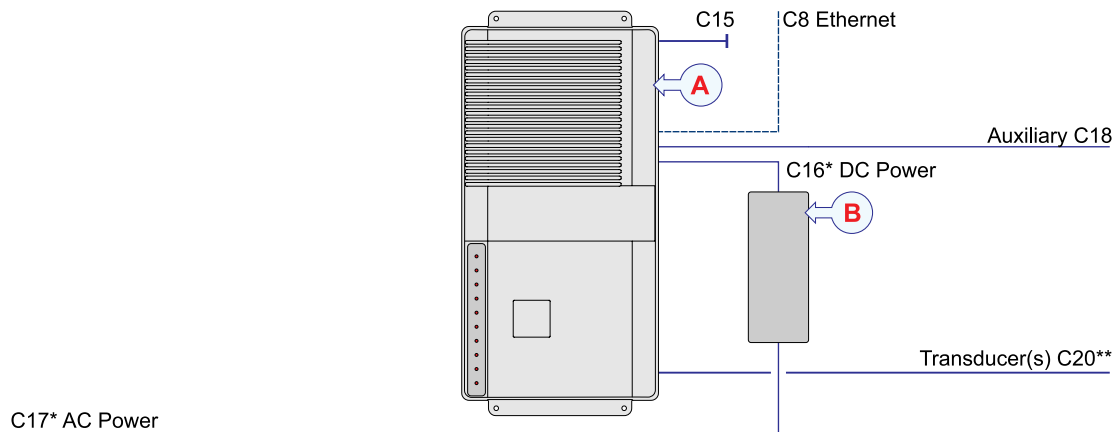

A *Wide Band Transceiver (WBT)*

B *Power Supply Unit*

Depending on the operational requirements, one or more Wide Band Transceiver (WBT) units may be used in the complete EK80 system. An Ethernet switch is required if more than one Wide Band Transceiver (WBT) is used.

Cables identified with an asterisk (\*) are system or commercial cables. These cables are provided with the EK80 delivery or the relevant item. One transducer cable (marked with a dual asterisk (\*\*)) is provided with each transducer.

### Related topics

[Cable plans, page 88](#)

[Cable layout and interconnections, page 85](#)

## Sonar room cable plan with two transceivers

The Wide Band Transceiver (WBT) cables include those used to connect the EK80 transceiver(s) to AC mains power, and to the transducer(s).

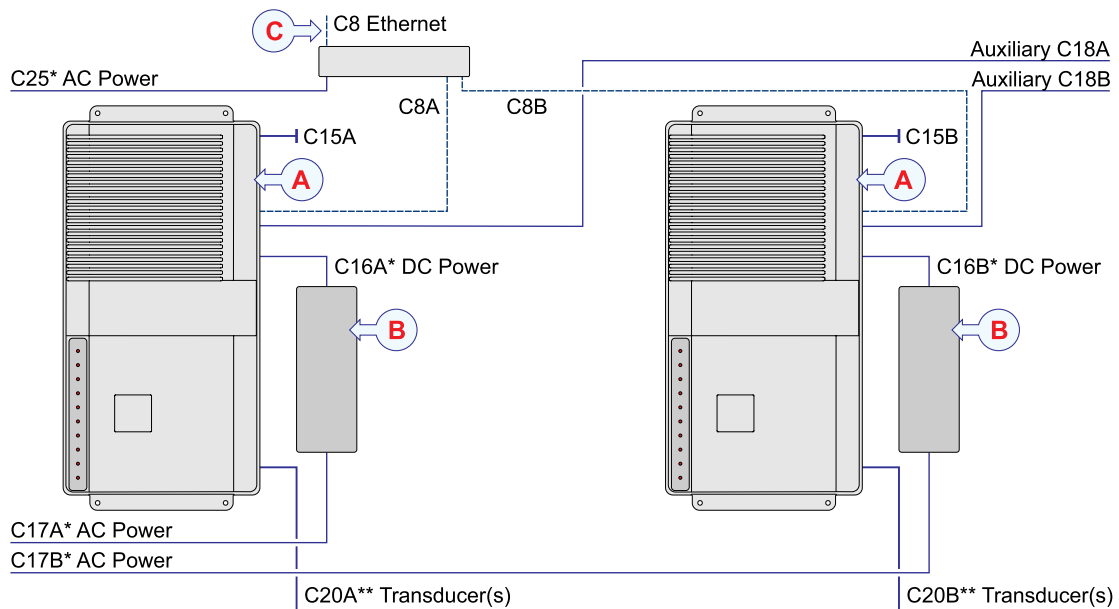

- A *Wide Band Transceiver (WBT)*
- B *Power Supply Unit*
- C *Ethernet switch*

Depending on the operational requirements, one or more Wide Band Transceiver (WBT) units may be used in the complete EK80 system. An Ethernet switch is required if more than one Wide Band Transceiver (WBT) is used.

Cables identified with an asterisk (\*) are system or commercial cables. These cables are provided with the EK80 delivery or the relevant item. One transducer cable (marked with a dual asterisk (\*\*)) is provided with each transducer.

### Related topics

[Cable plans, page 88](#)

[Cable layout and interconnections, page 85](#)

## Sonar room cable plan with WBT Cabinet

The Wide Band Transceiver (WBT) cables include those used to connect the EK80 transceiver(s) to AC mains power, and to the transducer(s).

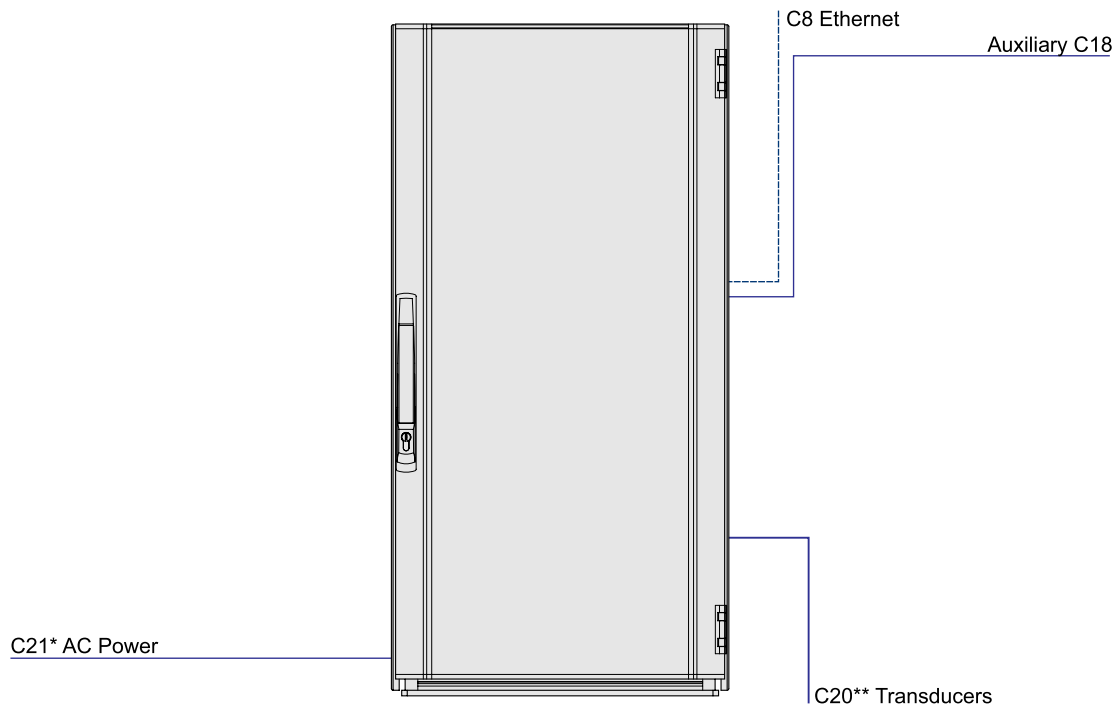

The WBT Cabinet is provided with a built-in power distributor. Only one power cable is required for connection to AC mains.

The transducer cables (one for each transducer) normally exit the cabinet through the its bottom.

Cables identified with an asterisk (\*) are system or commercial cables. These cables are provided with the EK80 delivery or the relevant item. One transducer cable (marked with a dual asterisk (\*\*)) is provided with each transducer.

### Related topics

[Cable plans, page 88](#)

[Cable layout and interconnections, page 85](#)

## EC150-3C cable plan

The cables are used to connect the Power Supply Unit to the transducer and to the Processor Unit. Synchronization is an optional feature.

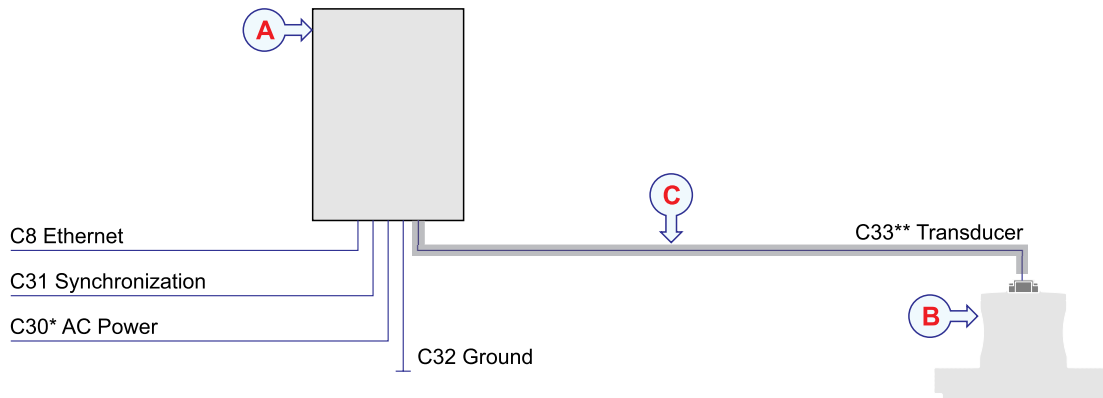

- A *Power Supply Unit*
- B *Transducer*
- C *Steel conduit*

### Comments

Cables identified with an asterisk (\*) are system cables. These cables are supplied with the EK80 delivery.

It is very important that a high-quality Ethernet cable is used. You must use CAT-5E STP (Shielded Twisted Pair) quality or better. If you use a cable with lower bandwidth capacity you will reduce the EK80 performance.

The transducer cable is 40 metres long. The cable can not be extended. The cable can be cut to match the installation requirements. Make sure that the cable length is minimum 15 metres.

### Related topics

[Cable plans, page 88](#)

[Cable layout and interconnections, page 85](#)

## List of EK80 cables

A set of cables is required to connect the EK80 units to each other, and to the relevant power source(s). Additional cables are required to connect the EK80 to peripheral devices.

Cables identified with an asterisk (\*) are system or commercial cables. These cables are provided with the EK80 delivery or the relevant item. One transducer cable (marked with a dual asterisk (\*\*)) is provided with each transducer.

### Topside cables

Cable	Type	From/To	Minimum requirements
C1*	AC power cable	From display to AC power outlet	2 x 1.5 mm <sup>2</sup> + 1.5 mm <sup>2</sup> Ground
C2*	AC power cable	From Processor Unit to AC power outlet	2 x 1.5 mm <sup>2</sup> + 1.5 mm <sup>2</sup> Ground
C3	Ground cable	From display to vessel ground	1 x 6 mm <sup>2</sup>
C4	Ground cable	From Processor Unit to vessel ground	1 x 6 mm <sup>2</sup>
C5*	Video cable	From Processor Unit to display	
	This is a commercial cable. The display cable is often physically attached to the display, and terminated in the “computer end” with a male connector. If the cable is not attached, it is normally provided with the display.		
C6*	Computer cable	From Processor Unit to keyboard	
C7*	Computer cable	From Processor Unit to mouse (or another similar device)	
C8	Ethernet cable	From Processor Unit to Wide Band Transceiver (WBT)	CAT5-E STP (Shielded Twisted Pair)
C9	Ethernet cable	From Processor Unit to local area network (LAN)	CAT5-E STP (Shielded Twisted Pair)
C10	Serial cable	From Processor Unit to external device(s)	2 x 4 x 0.5 mm <sup>2</sup>
C11–14	Not used		

### Sonar room cables

Cable	Type	From/To	Minimum requirements
C8	Ethernet cable	From Processor Unit to Wide Band Transceiver (WBT)	CAT5-E STP (Shielded Twisted Pair)
C15	Ground cable	From Wide Band Transceiver (WBT) to vessel ground	1 x 6 mm <sup>2</sup>



Cable	Type	From/To	Minimum requirements
C16*	DC power cable	From Power Supply Unit to Wide Band Transceiver (WBT)	
	The DC power cable from the WBT power supply to the transceiver is provided with the power supply. The Wide Band Transceiver (WBT) can be powered by a large capacity battery. The battery must be placed close to the Wide Band Transceiver (WBT) to minimize power loss in the cable.		
C17*	AC power cable	From Power Supply Unit to AC power outlet	2 x 1.5 mm <sup>2</sup> + 1.5 mm <sup>2</sup> Ground
C18	Synchronization cable	From Wide Band Transceiver (WBT) AUXILIARY socket to external synchronisation system.	4 x 0.5 mm <sup>2</sup>
	If you use more than one Wide Band Transceiver (WBT) in your EK80 system, all synchronization input signals to the AUXILIARY ports must be provided by the same source.		
C19	Not used		
C20**	Transducer cable	From Wide Band Transceiver (WBT) to transducer	
	The transducer cable is provided with the transducer.		
C21*	AC power cable	From WBT Cabinet to AC power outlet	2 x 1.5 mm <sup>2</sup> + 1.5 mm <sup>2</sup> Ground
C22-24	Not used		
C25*	AC power cable	From Ethernet switch to AC power outlet	2 x 1.5 mm <sup>2</sup> + 1.5 mm <sup>2</sup> Ground
	The power cable on the Ethernet switch may comprise a separate power supply.		
C26-29	Not used		

### EC150-3C cables

Cable	Type	From/To	Minimum requirements
C8	Ethernet cable	From Power Supply Unit to Processor Unit	CAT5-E STP (Shielded Twisted Pair)
	It is very important that a high-quality Ethernet cable is used. You must use CAT-5E STP (Shielded Twisted Pair) quality or better. If you use a cable with lower bandwidth capacity you will reduce the EK80 performance.		
C30*	AC power cable	From Power Supply Unit to AC power outlet	2 x 1.5 mm <sup>2</sup> + 1.5 mm <sup>2</sup> Ground
C31	Synchronization cable	From Power Supply Unit to synchronization system	2 x 2 x 0.5 mm <sup>2</sup>
	Synchronization is an optional feature. We strongly recommend that each signal cable is equipped with galvanic isolation. Galvanic isolation reduces the risk of noise.		
C32	Ground cable	From Power Supply Unit to vessel ground	1 x 6 mm <sup>2</sup>

Cable	Type	From/To	Minimum requirements
C33**	Transducer cable	From Power Supply Unit to transducer	
	The transducer cable is provided with the transducer. The transducer cable enters the Power Supply Unit through the cable gland at the bottom of the cabinet. The transducer cable is 40 metres long. The cable can not be extended. The cable can be cut to match the installation requirements. Make sure that the cable length is minimum 15 metres.		

**Comments**

- It is very important that high-quality Ethernet cables are used. You must use CAT-5E STP (Shielded Twisted Pair) quality or better. If you use cables with lower bandwidth capacity you will reduce the EK80 performance. **Do not** connect the Processor Unit to the Wide Band Transceiver (WBT) using an existing local area network (LAN).
- The grounding cable for the WBT Cabinet is not listed. The grounding cable is a special braided wire that is physically connected to the cabinet. It is connected to vessel ground by means of the cabinet’s shock absorbers.
- More than one serial line cable may be required to connect the Processor Unit to external devices. To identify these cables, use postfix letters. (C10A, C10B, C10C...).
- The EK80 is often a part of a project delivery. For such deliveries, specific project cable drawings are established to show all the main cables, and how the various products are connected. In such project cable drawings, the EK80 cables may be identified as **EK80/Cx**.

# Installing the EK80 cables

## Topics

- [Prerequisites for cable installation, page 97](#)
- [Installing the EK80 topside cables, page 98](#)
- [Installing the Wide Band Transceiver \(WBT\) cables, page 100](#)
- [Processor Unit rear connectors, page 102](#)
- [Wide Band Transceiver \(WBT\) connectors, page 104](#)
- [Using a steel conduit to protect the transducer cable, page 105](#)
- [Splicing the transducer cable, page 107](#)

## Prerequisites for cable installation

Correct wiring is crucial for the operational performance of the EK80. Electrical connections can only be made by skilled personnel (ship electricians, technicians or engineers). The installation shipyard must prepare detailed drawings of the electrical system, and identify each cable. Observe the basic cable requirements.

You must be equipped with a standard set of tools. This tool set must comprise the normal tools for cable installation tasks. This includes different screwdriver types, pliers, spanners, a cable stripper, a soldering iron, etc. Each tool must be provided in various sizes. We recommend that all tools are demagnetized to protect your equipment. Depending on the tasks at hand, additional tools may be required.

Refer to the cable plans and the list of cables. Detailed information about cable specifications, termination and connectors are provided in the relevant cable drawings. Unless otherwise specified, all cables are supplied with the EK80 delivery. In order to ease the access for maintenance purposes, and to allow for vibration, make sure that some slack is provided for each cable.

### Note

---

*All electronic installations and corresponding wiring must be in accordance with the vessel's national registry and corresponding maritime authority and/or classification society.*

*Only skilled and authorized personnel can install the EK80 cables.*

*Kongsberg Maritime will not accept any responsibility for errors, malfunctions or damage to system or personnel caused by improper wiring.*

---

### Related topics

[Installing the EK80 cables, page 97](#)

[Cable layout and interconnections, page 85](#)

## Installing the EK80 topside cables

The topside/bridge cables include those used to connect the EK80 Processor Unit and the display to each other, to AC mains power, and to external devices. One high capacity Ethernet cable connects the Processor Unit to the Wide Band Transceiver (WBT).

### Procedure

- 1 Connect the power cables.
  - a Connect the power cable from the display to the AC power outlet. (C1)
  - b Connect the power cable from the Processor Unit to the AC power outlet. (C2)

Standard commercial AC mains cables are used. Each cable is supplied with the relevant unit. The typical cable length is between 1,5 and 2 meters. If this is too short you must use an extension cable (not recommended), mount a new power outlet within range, or make your own power cable with sufficient length.

For more information, see the cable details:

- [AC power cable using IEC C13 inline socket, page 137](#)

- 2 Connect the ground cables.
  - a If applicable, connect the ground cable from the display to vessel ground. (C3)
  - b Connect the ground cable from the Processor Unit to vessel ground. (C4)

These cables must be provided by the installation shipyard. For more information, see the cable details:

- [Ground cable, page 139](#)

- 3 Connect the video cable from the Processor Unit to the display. (C5)

The display cable is often physically attached to the display, and terminated in the “computer end” with a male connector. If the cable is not attached, it is normally provided with the display.

The graphic adapter on the rear side of the Processor Unit provides two DVI connectors, one for HDMI and two for Mini DisplayPort. Choose the connector that fits your display cable. If you have two displays both can be connected simultaneously, and can use the operating system functionality to set up different presentations.

Keep the display cable as short as possible. If the cable is too long, it may pick up electric noise, and this will reduce the image quality.

For more information, see the cable details:

- [Processor Unit graphic adapter, page 112](#)

To learn more about the various video standards, explore these Wikipedia pages.

- [DVI](#)
- [HDMI](#)
- [DisplayPort](#)

- 4 Connect the cable from the Processor Unit to the keyboard. (C6)
- 5 Connect the cable from the Processor Unit to the mouse (or another similar device). (C7)
- 6 Connect the Ethernet cable from the Processor Unit to the Wide Band Transceiver (WBT). (C8)

**Note**

---

*It is very important that a high-quality Ethernet cable is used. You must use CAT-5E STP (Shielded Twisted Pair) quality or better. If you use a cable with lower bandwidth capacity you will reduce the EK80 performance. Do not connect the Processor Unit to the Wide Band Transceiver (WBT) using an existing local area network (LAN).*

---

Depending on the operational requirements, one or more Wide Band Transceiver (WBT) units may be used in the complete EK80 system. An Ethernet switch is required if more than one Wide Band Transceiver (WBT) is used.

For more information, see the cable details:

- [RJ45 High speed Ethernet cable \(1000Base-t\), page 147](#)

- 7 Connect the Ethernet cable from the Processor Unit to the local area network (LAN). (C9)

For more information, see the cable details:

- [RJ45 High speed Ethernet cable \(1000Base-t\), page 147](#)

- 8 Connect the serial cables from the Processor Unit to the relevant external devices. (C10)

For more information, see the cable details:

- [Cable drawings and specifications, page 136](#)

- 9 If applicable, connect the signal cable from the Processor Unit to the synchronization system. (C10)

For more information, see the cable details:

- [K-Sync interface to generic RS-232 synchronization input, page 148](#)
- [Simrad TU40 interface to generic RS-232 synchronization input, page 151](#)

**Related topics**

[Installing the EK80 cables, page 97](#)

[Cable layout and interconnections, page 85](#)

## Installing the Wide Band Transceiver (WBT) cables

The Wide Band Transceiver (WBT) cables include those used to connect the EK80 units to AC mains power, as well as the control cables between the units. One high capacity Ethernet cable connects the Wide Band Transceiver (WBT) to the topside Processor Unit.

### Procedure

- 1 Connect the power cables.  
If a WBT Cabinet is used:
  - a Connect the power cable from the WBT Cabinet to the AC power outlet. (C21)
  - b Verify that each Wide Band Transceiver (WBT) is connected to the power distributor at the bottom of the cabinet.  
If a WBT Cabinet is *not* used:
  - a Connect the power cable from each Power Supply Unit to the relevant Wide Band Transceiver (WBT). (C16)
  - b Connect the power cable from each Power Supply Unit to the AC power outlets. (C17)

Standard commercial AC mains cables are used. Each cable is supplied with the relevant unit. The typical cable length is between 1,5 and 2 meters. If this is too short you must use an extension cable (not recommended), mount a new power outlet within range, or make your own power cable with sufficient length.

For more information, see the cable details:

- [AC power cable using IEC C13 inline socket, page 137](#)

- 2 Connect the ground cables.  
If a WBT Cabinet is used:
  - a Verify that ground strap from the WBT Cabinet to vessel ground is secured.
  - b Verify that each Wide Band Transceiver (WBT) is grounded inside the WBT Cabinet.  
If a WBT Cabinet is *not* used:
  - a Connect the ground cable from each Wide Band Transceiver (WBT) to vessel ground. (C15)  
This cable must be provided by the installation shipyard. For more information, see the cable details:
    - [Ground cable, page 139](#)
- 3 If you wish to use the synchronization method offered by the AUXILIARY socket on the Wide Band Transceiver (WBT), make the necessary connection. (C18)  
For more information, see the cable details:
  - [Synchronization using the Auxiliary socket on the transceiver, page 129](#)
  - [Auxiliary connector for synchronization, page 153](#)

- 4 Connect the transducer cables from each transducer to the relevant Wide Band Transceiver (WBT).

**Related topics**

[Installing the EK80 cables, page 97](#)

[Cable layout and interconnections, page 85](#)

## Processor Unit rear connectors

The rear panel on the Processor Unit holds connectors for the various EK80 cables. Additional connectors are provided on the front panel. These are not used.

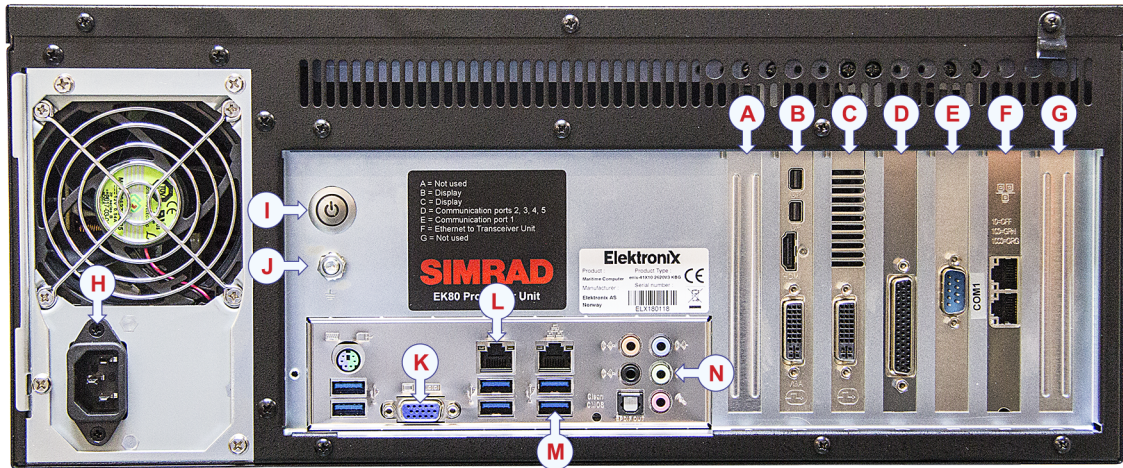

**A** Not used

**B** Video cable: From Processor Unit to display (C5)

This is a commercial cable. The display cable is often physically attached to the display, and terminated in the “computer end” with a male connector. If the cable is not attached, it is normally provided with the display.

If you need to use a DVI-to-SVGA adapter to connect your display, you must use the left DVI-I output. This is the only output that supports the SVGA signals.

**C** Video cable

**D** Serial cables: From Processor Unit to external device(s) (C10)

**E** Serial cables: From Processor Unit to external device(s) (C10)

**F** Ethernet cable: From Processor Unit to Wide Band Transceiver (WBT) (C8)

Only the top Ethernet socket is used to communicate with the Wide Band Transceiver (WBT).

It is very important that a high-quality Ethernet cable is used. You must use CAT-5E STP (Shielded Twisted Pair) quality or better. If you use a cable with lower bandwidth capacity you will reduce the EK80 performance. Do not connect the Processor Unit to the Wide Band Transceiver (WBT) using an existing local area network (LAN).

**G** Not used

**H** AC power cable: From Processor Unit to uninterruptible power supply (UPS) (C2)

**I** Power On/Off

**J** Ground cable: From Processor Unit to vessel ground (C4)

**K** Not used



- L** Ethernet cable: From Processor Unit to local area network (LAN) (C9)  
If you wish to connect the Processor Unit to the ship's local area network, use the left Ethernet socket on the connection panel. Do not use the adapter in Slot F.
- M** USB (Universal Serial Bus) sockets  
From Processor Unit to keyboard (C6)  
From Processor Unit to mouse (or another similar device) (C7)
- N** Audio cable: Not used

**Related topics**

[Installing the EK80 cables, page 97](#)

[Cable layout and interconnections, page 85](#)

## Wide Band Transceiver (WBT) connectors

All sockets for the system cables are located on the Wide Band Transceiver (WBT) side panel.



- A** Ground cable: From Wide Band Transceiver (WBT) to vessel ground (C15)
- B** Transducer cable: From Wide Band Transceiver (WBT) to transducer (C20)
- C** Ethernet cable: From Wide Band Transceiver (WBT) to Processor Unit (C8)
- D** DC power cable: From Wide Band Transceiver (WBT) to Power Supply Unit (C16)
- E** Auxiliary connector for synchronization (Optional)

The Wide Band Transceiver (WBT) can be powered by a large capacity battery. The battery must be placed close to the Wide Band Transceiver (WBT) to minimize power loss in the cable.

### Related topics

[Installing the EK80 cables, page 97](#)

[Cable layout and interconnections, page 85](#)

## Using a steel conduit to protect the transducer cable

A steel conduit must be used to protect the transducer cable. The steel conduit must preferably be straight. Start the conduit immediately above the transducer, and terminate it well above the water line.

It is strongly recommended to lay a steel conduit from the cable gland above the transducer to the EK80 transceiver, and to pull the transducer cable through this conduit. The conduit serves two purposes. It will protect the cable, and shield it from electric noise. Depending on how the steel conduit is terminated over the transducer, it may also secure the watertight integrity of the vessel.

There are several reasons for this.

- It will make it easier at a later stage to replace the transducer.
- It will protect the cables.
- Noise and interference from other electrical equipment is greatly reduced.
- The risk of flooding is greatly reduced when the steel conduit is terminated above the water line.

With a steel conduit the installation will satisfy the European Union regulations for electromagnetic compatibility (EMC) interference. Without a steel conduit, there is a risk of reduced EK80 performance.

### Steel conduit quality and shielding

The steel conduit must be unbroken and watertight from the transducer to above the water line. From there, the cable can be pulled further, or a junction box can be installed to facilitate further connections.

Note

---

*The steel conduit must act as a continuous electrical screen all the way.*

---

If two or more transducers are installed close to each other it is possible to pull their cables in the same steel conduit, provided the conduit diameter is increased accordingly. However, for easy replacement it is recommended that each transducer has its own steel conduit.

### Steel conduit minimum dimensions

The dimensions of the steel conduit must be specified and/or verified by the relevant maritime authority and/or classification society. The minimum dimensions are:

- **Inside diameter:** 35 mm
- **Wall thickness:**
  - Galvanized: 4.5 mm
  - Not galvanized: 6 mm

**Related topics**

[Installing the EK80 cables, page 97](#)

[Cable layout and interconnections, page 85](#)

## Splicing the transducer cable

If you need to extend the transducer cable, you must splice it correctly. This is very important, as any splice is very vulnerable for noise.

Cable can be spliced using two different methods:

- Splicing using a grounded junction box
- Splicing using a junction box that is isolated from vessel's ground

The following items are required.

- A metal junction box with cable glands designed for electromagnetic compatibility (EMC). The junction box must contain a suitable terminal block. The terminal block must provide solid fastening of the cable ends as well as sufficient insulation between the wires.
- The necessary length of transducer cable.

The cable between the junction box and the transceiver must be supplied by Kongsberg Maritime, and this must be the same type as used on the transducer.

Electrical installations can only be done by certified electricians. All necessary tools and instruments required must be available. The installation shipyard must prepare detailed drawings of the electrical system, and identify each cable.

You must be equipped with a standard set of tools. This tool set must comprise the normal tools for electronic and electromechanical tasks. This includes different screwdriver types, pliers, spanners, a cable stripper, a soldering iron, etc. Each tool must be provided in various sizes. We recommend that all tools are demagnetized to protect your equipment.

### Note

---

*Do not solder the wires together using only electrical tape for insulation. This will result in electrical noise and reduced operational performance.*

---

### Topics

[Splicing the cable using a junction box isolated from vessel's ground, page 107](#)

[Splicing the cable using a grounded junction box, page 108](#)

## **Splicing the cable using a junction box isolated from vessel's ground**

Do not solder the wires together using only electrical tape for insulation. This will result in electrical noise and reduced operational performance.

Do not connect the cable screen to vessel ground.

- A** The junction box is isolated from vessel ground.
- B** Cable gland
- C** Terminal block
- D** Cable
- E** Cable screen (*Do not connect the cable screen to vessel ground.*)

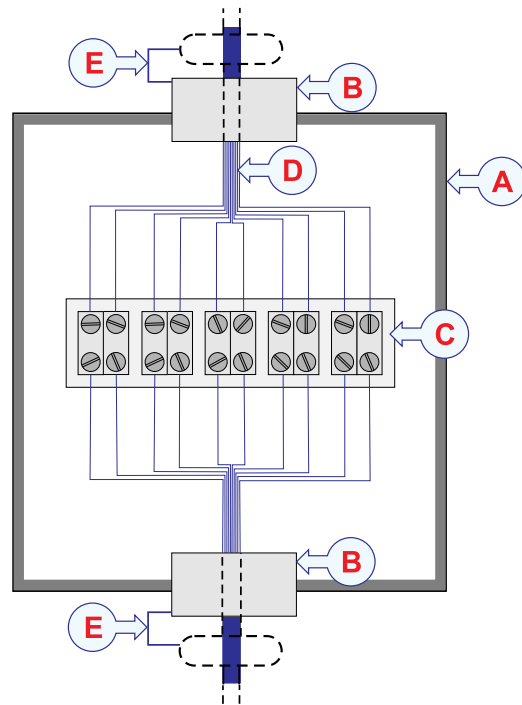

### Procedure

- 1 Mount the junction box in a suitable location.
- 2 Terminate the steel conduits containing the transducer cable as close to the junction box as possible.
- 3 Make sure that the junction box chassis is not connected to vessel ground.

Use additional insulation if this is necessary to isolate the junction box completely.

- 4 Remove the insulation from the transducer cable. Connect the individual wires to the terminal block.
- 5 Remove the insulation from the extension cable. Connect the individual wires to the terminal block.
- 6 Make sure that you have connected the wires 1:1, and that the colours match.
- 7 Connect the cable screens to the cable glands in the junction box.

### Related topics

[Splicing the transducer cable, page 107](#)

[Cable layout and interconnections, page 85](#)

### Splicing the cable using a grounded junction box

Do not solder the wires together using only electrical tape for insulation. This will result in electrical noise and reduced operational performance.

- A** Junction box
- B** Cable gland
- C** Terminal block
- D** Cable
- E** Cable screen (*Do not connect the cable screen to vessel ground.*)
- F** The junction box may be connected to vessel ground.

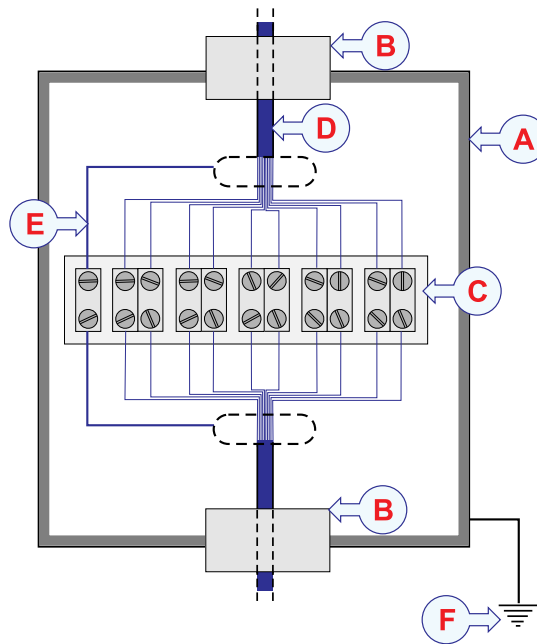

**Procedure**

- 1 Mount the junction box in a suitable location.
  - 2 Terminate the steel conduit containing the transducer cable to the junction box housing, or as close to the junction box as possible.
  - 3 Feed the cables through the cable glands.
  - 4 Remove the insulation from the transducer cable. Connect the individual wires to the terminal block.
  - 5 Remove the insulation from the extension cable. Connect the individual wires to the terminal block.
  - 6 Make sure that you have connected the wires 1:1, and that the colours match.
  - 7 Connect the screens from both cables together.
  - 8 Make sure that the cable screens do not have any electrical connection to the junction box housing or the cable gland.
- If necessary, insulate the screens.

**Related topics**

- [Splicing the transducer cable, page 107](#)
- [Cable layout and interconnections, page 85](#)

## Connections to specific hardware items

### Topics

[KVM \(Keyboard Video Mouse\) principle for a remote operating position, page 110](#)

[Processor Unit graphic adapter, page 112](#)

[Processor Unit serial adapter, page 114](#)

[Serial line splitter Øverland UPC-3005, page 118](#)

[Serial line splitter Øverland UPC-5000P, page 122](#)

### KVM (Keyboard Video Mouse) principle for a remote operating position

The Black Box DKM system offers a flexible and modular KVM extension system that allows you to extend video, keyboard and mouse long distances from the host computer.

- A** Local user
- B** Remote user
- C** KVM Receiver
- D** KVM Transmitter
- E** Processor Unit
- F** The communication between the two operating positions is made using an Ethernet cable.

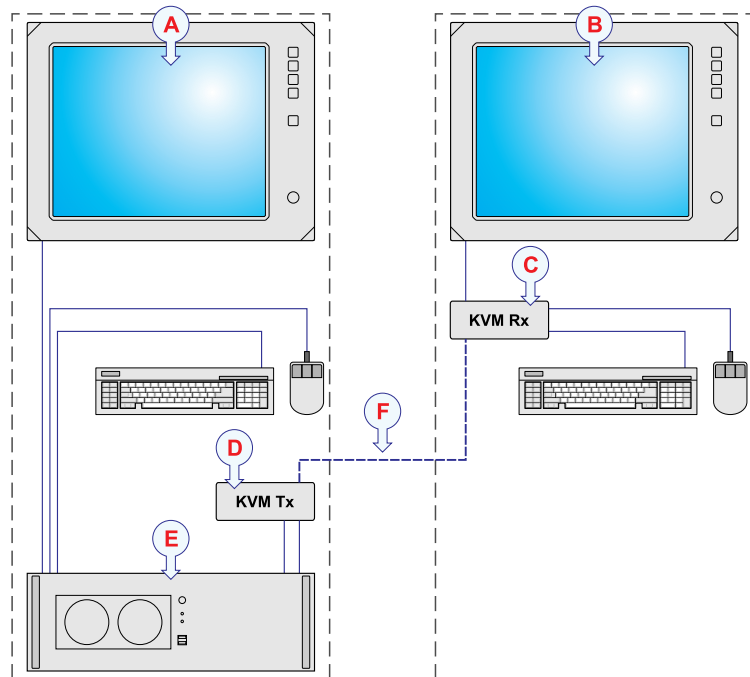

The KVM (Keyboard Video Mouse) technology offers a simple way to remote control the EK80 from a secondary position. In a typical situation, KVM units allow you to use the

EK80 from the bridge even though the EK80 Processor Unit and main operating station is located in a laboratory or instrument room several decks below.

The communication between the two operating positions is made using an Ethernet cable. It is very important that a high-quality Ethernet cable is used. You must use CAT-5E STP (Shielded Twisted Pair) quality or better. The maximum length of the



Ethernet cable between the KVM units is specified by the KVM manufacturer. Unless otherwise specified, this cable must be provided by the installation shipyard.

**Note**

---

*Unless specified in a contract, a KVM (Keyboard Video Mouse) system is not included in the standard EK80 delivery. These are commercial items that can be purchased locally.*

---

**KVM Modular housing**

Each KVM Transmitter and Receiver is provided as a printed circuit board, and these must be placed in a modular housing unit. Depending on type, each housing unit can accept two or more circuit boards. The housing unit contains an integrated power supply. For redundancy purposes it will also operate from an external 5VDC power supply. The housing unit can be installed on a desktop, on the bulkhead or in a 19" rack using dedicated adapters.



**KVM Modular Receiver board**

Each KVM Modular Receiver board is mounted in a dedicated housing unit at the remote operating position. The receiver distributes the video signal to the display, and allows you to connect a keyboard and a mouse.

**KVM Modular Transmitter board**

Each KVM Modular Transmitter board is mounted in a dedicated housing unit close to the EK80 Processor Unit. The transmitter accepts the video signal from the Processor Unit. It also connects with a USB cable to provide keyboard and mouse functionality to the remote position. Each transmitter can be connected to one receiver.

**More information**

For more information, refer to the end-user documentation provided by the manufacturer.

**Related topics**

[Cable plans, page 88](#)

[Cable layout and interconnections, page 85](#)

## Processor Unit graphic adapter

The graphic adapter used by the Enix Processor Unit is the **ER93F** manufactured by TUL Embedded.

### Description

The manufacturer's website offers the following description of the ER39F graphic adapter.

The ER93F Graphic Card is provided with two DVI, two Mini DP and one HDMI port, allowing system customers to implement multi-display output without additional video converters or splitters. The graphic card's complete range of output ports is perfect for developing new system products or upgrading an existing product. The ER93F is particularly suitable for upgrading existing digital signage equipment or arcade machine. Apart from the variety of output ports, the two sets of Mini DP and DVI outputs allow old systems to be upgraded directly to multi-display solutions.

The ER93F Graphic Card uses the embedded E6760 graphics chip from AMD and incorporates 128-bit 1GB GDDR5 memory in MCM BGA packaging. Industrial-grade passive electronic components are used throughout the entire card and it has been tested between -20 ~ 55°C to ensure ideal system compatibility and reliability. For industrial and automation industry customers, this resolves any doubt about compatibility and stability on production selection and system configuration.

*[www.tulembedded.com](http://www.tulembedded.com), March 2015*

- **Manufacturer:** TUL Embedded
- **Manufacturer's website:** <http://www.tulembedded.com>

### Important

---

Keep the display cable as short as possible. If the cable is too long, it may pick up electric noise, and this will reduce the image quality.

---

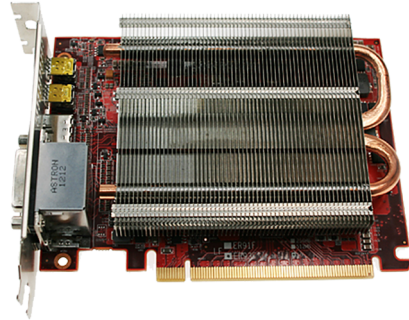

*(Photo downloaded from [www.tulembedded.com](http://www.tulembedded.com), 2015)*

## Graphic output formats

The outputs from the graphic adapters are positioned as follows:

- A *Mini DisplayPort output*
- B *Mini DisplayPort output*
- C *HDMI output*
- D *DVI-I output*
- E *DVI-D output*

Note

The two DVI outputs are not identical. If you wish to connect a standard VGA display using a DVI-to-VGA adapter, you must use the left output (D).

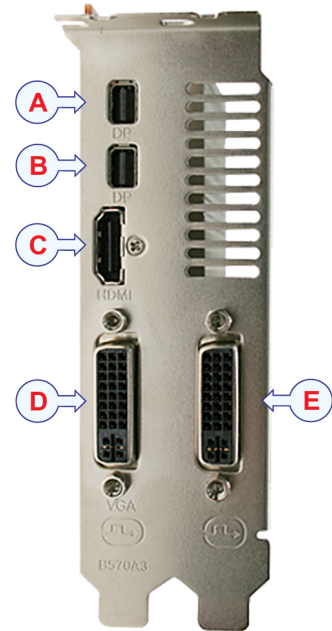

(Photo downloaded from [www.tulembedded.com](http://www.tulembedded.com), 2015)

## Graphic output resolutions

The following output resolutions are provided.

- **Mini DisplayPort:** Maximum resolution 2560 x 1600 px
- **HDMI:** Maximum resolution 1920 x 1200 px
- **DVI-I/D:** Maximum resolution 2560 x 1600 px
- **VGA (using adapter):** Maximum resolution 2048 x 1536 px

Tip

To learn more about the various video standards, explore these Wikipedia pages.

- [DVI](#)
- [HDMI](#)
- [DisplayPort](#)

## Related topics

[Cable plans, page 88](#)

[Cable layout and interconnections, page 85](#)

## Processor Unit serial adapter

The Moxa CP114EL-I adapter is used in the EK80 Processor Unit to provide serial communication.

### Topics

[Moxa CP114EL-I overview, page 114](#)

[Moxa CP114EL-I connectors, page 115](#)

[Setting up the Moxa CP114EL-I serial ports, page 116](#)

### Moxa CP114EL-I overview

The Processor Unit is equipped with a Moxa CP114EL-I serial adapter board. The board provides four serial lines.

The Moxa CP114EL-I serial adapter supports RS-232, RS-422 and RS-485 (both 2 and 4-wire). The connections to the board are made using a converter cable with four 9-pin male D-subminiature connectors. The converter cable is supplied with the Processor Unit.



- **Manufacturer:** Moxa
- **Manufacturer's website:** <https://www.moxa.com>

### Serial line support

The serial adapter supports the following interface formats.

- **Port 1:** RS-232 / RS-422 / RS-485
- **Port 2:** RS-232 / RS-422 / RS-485
- **Port 3:** RS-232 / RS-422 / RS-485
- **Port 4:** RS-232 / RS-422 / RS-485

In order to set up the serial ports to match your interface requirements, use the dedicated software utility in the device driver. There are neither jumpers nor DIP switches on the circuit board.

### Related topics

[Cable plans, page 88](#)

[Processor Unit serial adapter, page 114](#)

[Cable layout and interconnections, page 85](#)

## Moxa CP114EL-I connectors

The serial lines are connected using a large D-Subminiature connector on the rear side of the Processor Unit.

### Adapter

A dedicated adapter cable is provided with the EK80 delivery. The adapter splits the large circuit board connector to four 9-pin D-Subminiature connectors. To make the individual connections easier, 9-pin D-Subminiature connectors with screw terminals are included in the delivery. Nuts to establish firm connections are also provided.

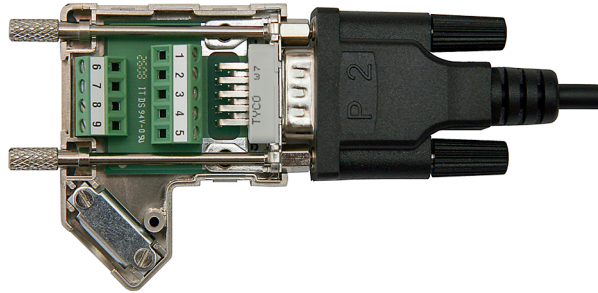

### Pin configuration

Moxa CP114EL-I connectors / Adapter cable				
Pin	RS-232	RS-422	RS-485 (4-wire)	RS-485 (2-wire)
1	DCD	TXD-(A)	TXD-(A)	
2	RxD	TXD+(B)	TXD+(B)	
3	TxD	RXD+(B)	RXD+(B)	Data-(B)
4	DTR	RXD-(A)	RXD-(A)	Data-(A)
5	Ground	Ground	Ground	Ground
6	DSR			
7	RTS			
8	CTS			
9				

### Related topics

[Cable plans, page 88](#)

[Processor Unit serial adapter, page 114](#)

[Cable layout and interconnections, page 85](#)

## Setting up the Moxa CP114EL-I serial ports

The interface ports provided by the **Moxa CP114EL-I** serial adapter board are configured using a dedicated driver application in the operating system.

### Prerequisites

This procedure is made for the Microsoft® Windows® 7 operating system. It is assumed that you are familiar with this operating system. Operation in Microsoft® Windows® 10 is very similar.

### Context

As long as you do not change the Processor Unit to another computer, or replace the serial adapter in your Processor Unit, you will only need to do this once.

#### Note

*This information is intended for certified maintenance technicians and service engineers from Kongsberg Maritime, or from a certified dealer, distributor or agent. It is assumed that you are familiar with the Windows® operating systems, computer technology, and interface principles. We strongly advise our end users not to alter the parameters described.*

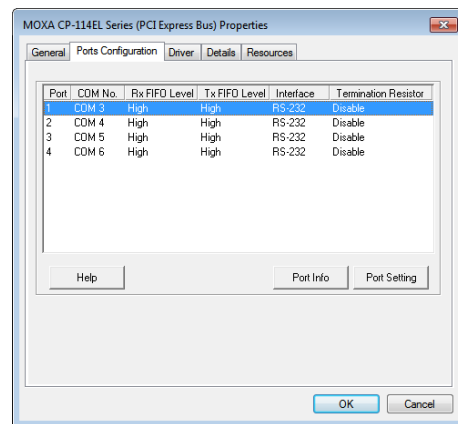

### Procedure

- 1 Select **Start**→**Control Panel**→**System**.
- 2 On the left side, select **Device Manager**.
- 3 In the **Device Manager** dialog box:
  - a Expand the **Multi-port serial adapters** option.
  - b Double-click **Moxa CP114EL Series (PCI Express Bus)** to open the configuration utility.
  - c Observe that the dedicated properties dialog box opens.
- 4 Open tab **Ports Configuration**, and select the serial port you wish to configure.
- 5 Select **Port Setting** to open the configuration dialog box

- 6 Set up the interface parameters for the chosen port to suit your preferences.

**Tip**

*Unless you are familiar with interface parameters offered, change only the **Interface** parameter to the required format. Leave the other settings with their default values.*

- 7 Click **OK** repeatedly to save your settings and exit the utility.

**Related topics**

[Cable plans, page 88](#)

[Processor Unit serial adapter, page 114](#)

[Cable layout and interconnections, page 85](#)

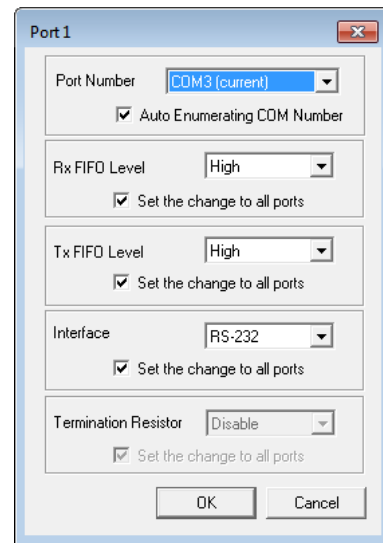

## Serial line splitter Øverland UPC-3005

On large installations with many hydroacoustic systems, these often require the same navigational information from a single sensor. Information such as current depth or speed is provided on serial format. One or more serial line splitters can be used to distribute the information from a single sensor to several different recipients.

The Øverland UPC-3005 is a serial line splitter with one input and eight outputs.

### Topics

[UPC-3005 Serial line splitter description, page 118](#)

[UPC-3005 Technical specifications, page 119](#)

[UPC-3005 Connections, page 120](#)

[UPC-3005 Dimensions, page 121](#)

### UPC-3005 Serial line splitter description

The Øverland UPC-3005 is a serial line splitter with one input and eight outputs.

UPC 3005 is a serial line splitter with 1 signal input, 3 x RS-232 and 5 x RS-422 outputs.

The powersupply and both signal inputs are galvanic isolated from the outputs.

All outputs are Short Circuit Protected.

*Information from the manufacturer's website, copied January 2017*

The serial line splitter is fitted with a DIN rail for easy mounting and replacement.

#### Note

*The serial line splitter requires a dedicated power supply providing 15 to 30 VDC.*

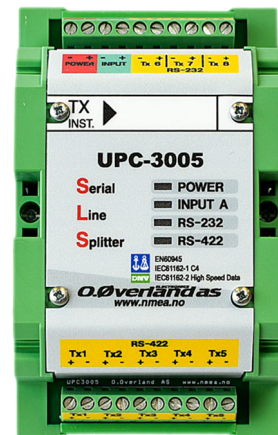

For more information about this serial line splitter, consult the manufacturer's website.

- **Manufacturer:** Øverland
- **Manufacturer's website:** <http://www.overland.no>

### Related topics

[Serial line splitter Øverland UPC-3005, page 118](#)

[Cable plans, page 88](#)

[Cable layout and interconnections, page 85](#)



## UPC-3005 Technical specifications

The Øverland UPC-3005 serial line splitter offers one input and eight RS-232 and RS-422 outputs.

- **Power requirements:** +15 - 30 VDC (2 W)
- **Input:** NMEA0183, RS-232, RS422, RS484, Current loop
- **Outputs:**
  - 5 x RS-422, (Maximum 50 mA)
  - 3 x RS-232

All outputs from the serial line splitter are short circuit protected.

- **Installation:** The serial line splitter is fitted with a DIN rail for easy mounting and replacement.
- **Outline dimensions:**
  - Length: 130 mm
  - Width: 80 mm
  - Height: 50 mm

Note \_\_\_\_\_

*This information was copied from the manufacturer's documentation. The technical specifications may be changed without prior notice. To ensure that your information is correct, always consult the manufacturer's own documents.*

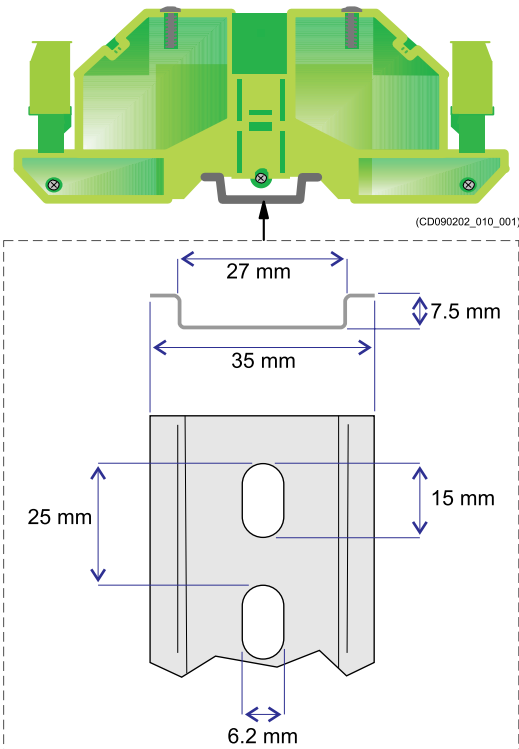

## Related topics

[Serial line splitter Øverland UPC-3005, page 118](#)

[Cable plans, page 88](#)

[Cable layout and interconnections, page 85](#)

### UPC-3005 Connections

The Øverland UPC-3005 serial line splitter offers one input and eight RS-232 and RS-422 outputs. The serial line splitter requires a dedicated power supply providing 15 to 30 VDC.

- A** Power requirements: +15 - 30 VDC
- B** Input
- C** Outputs: 3 x RS-232
- D** Outputs: 5 x RS-422

**Note**

*This information was copied from the manufacturer's documentation. The technical specifications may be changed without prior notice. To ensure that your information is correct, always consult the manufacturer's own documents.*

**Related topics**

- [Serial line splitter Øverland UPC-3005, page 118](#)
- [Cable plans, page 88](#)
- [Cable layout and interconnections, page 85](#)

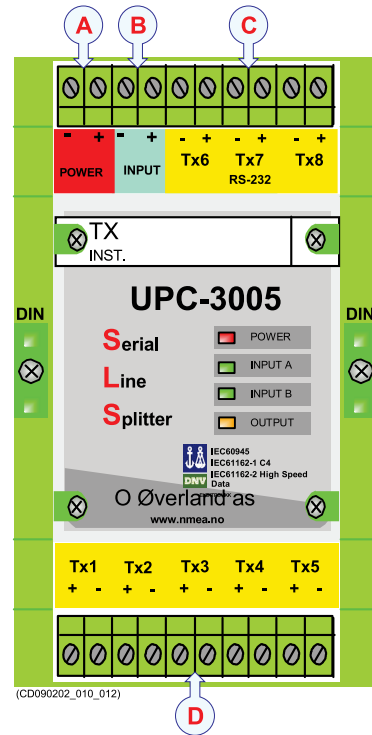

## UPC-3005 Dimensions

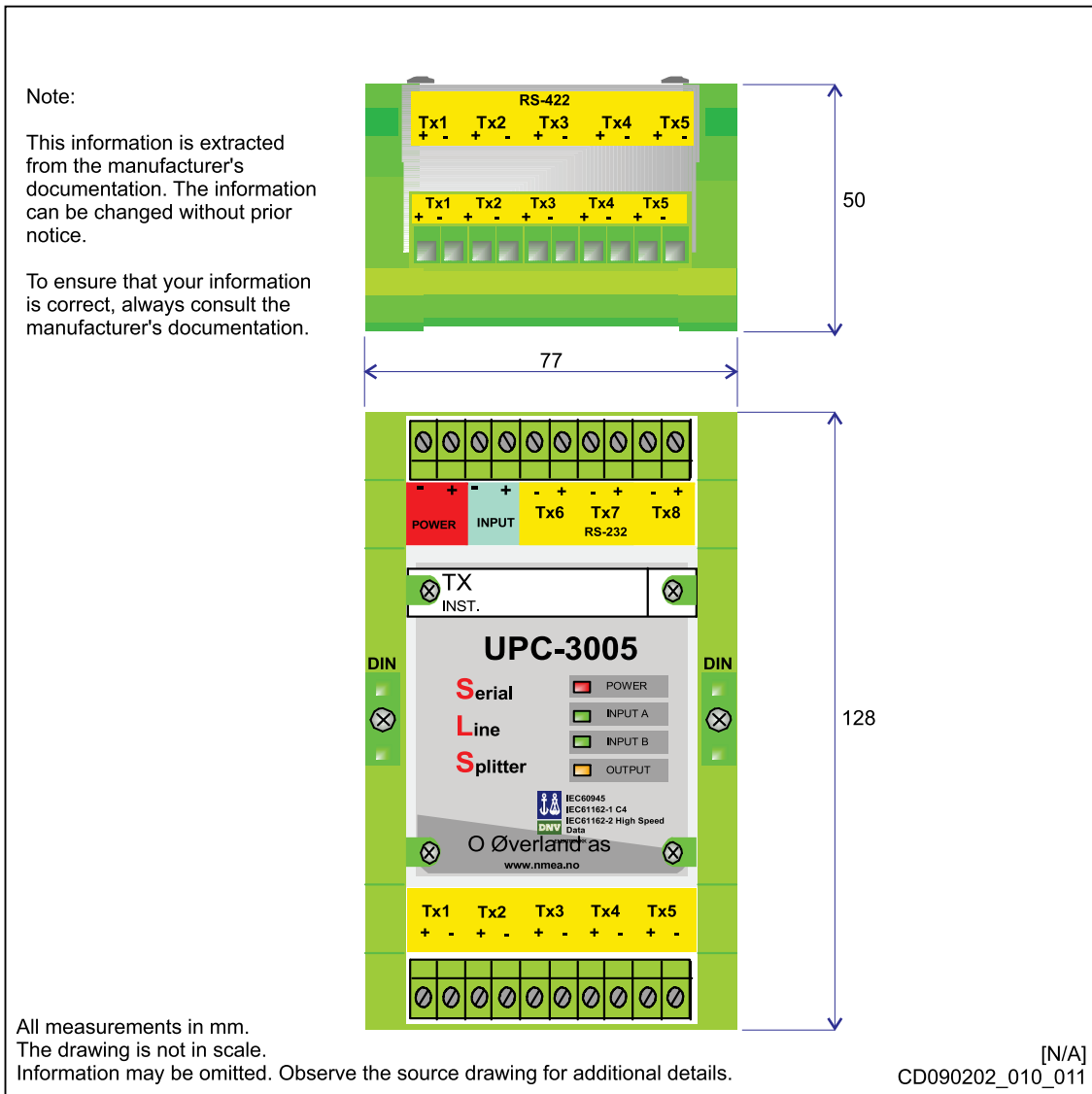

### Related topics

[Serial line splitter Øverland UPC-3005, page 118](#)

[Cable plans, page 88](#)

[Cable layout and interconnections, page 85](#)

## Serial line splitter Øverland UPC-5000P

On large installations with many hydroacoustic systems, these often require the same navigational information from a single sensor. Information such as current depth or speed is provided on serial format. One or more serial line splitters can be used to distribute the information from a single sensor to several different recipients.

The Øverland UPC-5000P is a serial line splitter with two separate inputs and fifteen outputs.

### Topics

[UPC-5000P Serial line splitter description, page 122](#)

[UPC-5000P Technical specifications, page 123](#)

[UPC-5000P Connections, page 124](#)

[UPC-5000P Dimensions, page 125](#)

### UPC-5000P Serial line splitter description

The Øverland UPC-5000P is a serial line splitter with two separate inputs and fifteen outputs.

Dual power input with autoswitch.

The two inputs **A** and **B** are separated with **A** as the primary input. If there is data on both **A** and **B** inputs, input **A** is used. Input **B** is used only if input **A** is idle. The power supply and both signal inputs are galvanic isolated from the outputs.

All outputs are short circuit protected.

*Information from the manufacturer's data sheet, copied May 2014*

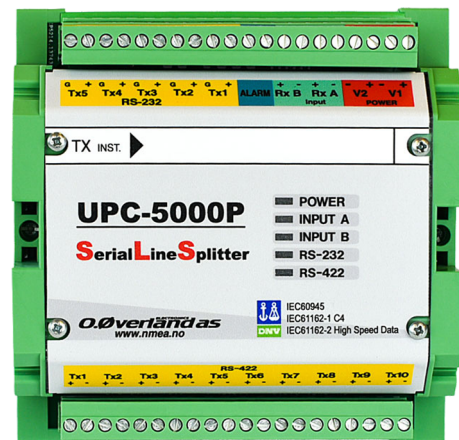

The serial line splitter is fitted with a DIN rail for easy mounting and replacement.

### Note

*The serial line splitter requires a dedicated power supply providing 15 to 30 VDC.*

For more information about this serial line splitter, consult the manufacturer's website.

- **Manufacturer:** Øverland
- **Manufacturer's website:** <http://www.overland.no>

**Related topics**

[Serial line splitter Øverland UPC-5000P, page 122](#)

[Cable plans, page 88](#)

[Cable layout and interconnections, page 85](#)

**UPC-5000P Technical specifications**

The Øverland UPC-5000P serial line splitter offers two separate inputs and fifteen RS-232 and RS-422 outputs.

- **Power requirements:**
  - Primary +15 - 30 VDC (2 W)
  - Secondary +15 - 30 VDC (2 W)
- **Input A (Primary):** NMEA0183, RS-232, RS422, RS484, Current loop
- **Input B (Secondary):** NMEA0183, RS-232, RS422, RS484, Current loop
- **Outputs:**
  - 10 x RS-422, (Maximum 50 mA)
  - 5 x RS-232

All outputs from the serial line splitter are short circuit protected.

- **For Current Loop input:** 100  $\Omega$  Parallel
- **Installation:** The serial line splitter is fitted with a DIN rail for easy mounting and replacement.
- **Outline dimensions:**
  - Length: 128 mm
  - Width: 128 mm
  - Height: 50 mm

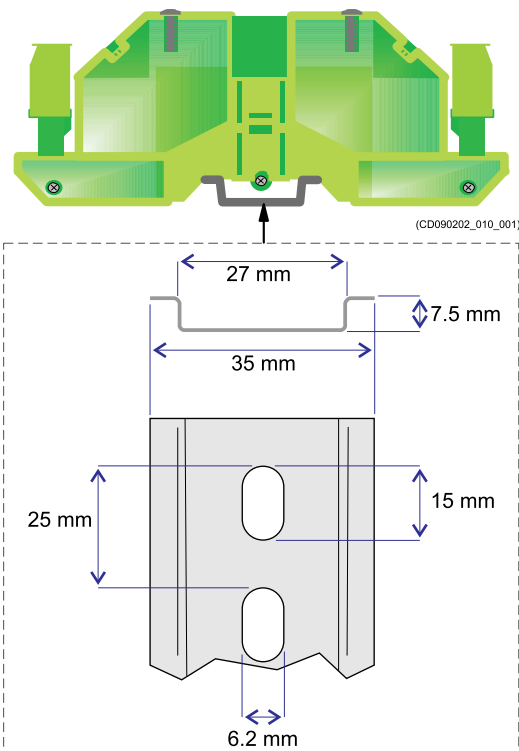
**Note**

*This information was copied from the manufacturer's documentation. The technical specifications may be changed without prior notice. To ensure that your information is correct, always consult the manufacturer's own documents.*

**Related topics**

[Serial line splitter Øverland UPC-5000P, page 122](#)

[Cable plans, page 88](#)

[Cable layout and interconnections, page 85](#)

### UPC-5000P Connections

The Øverland UPC-5000P serial line splitter offers two separate inputs and fifteen RS-232 and RS-422 outputs. The serial line splitter requires a dedicated power supply providing 15 to 30 VDC.

- A** Outputs: 5 x RS-232
- B** Relay NO/NC by internal strap
- C** Input
- D** Power requirements: +15 - 30 VDC
- E** Outputs: 10 x RS-422

Note \_\_\_\_\_

*This information was copied from the manufacturer's documentation. The technical specifications may be changed without prior notice. To ensure that your information is correct, always consult the manufacturer's own documents.*

#### Related topics

- [Serial line splitter Øverland UPC-5000P, page 122](#)
- [Cable plans, page 88](#)
- [Cable layout and interconnections, page 85](#)

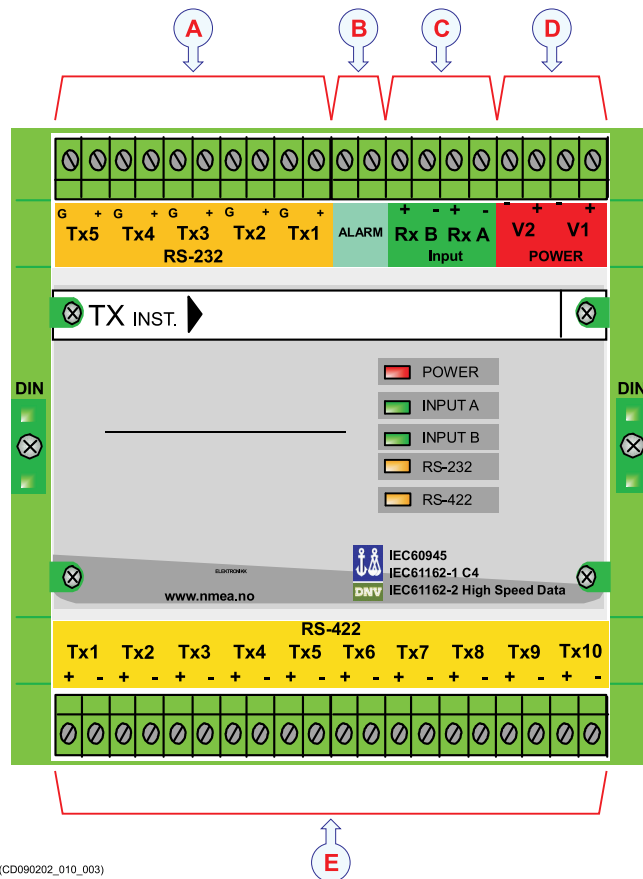

### UPC-5000P Dimensions

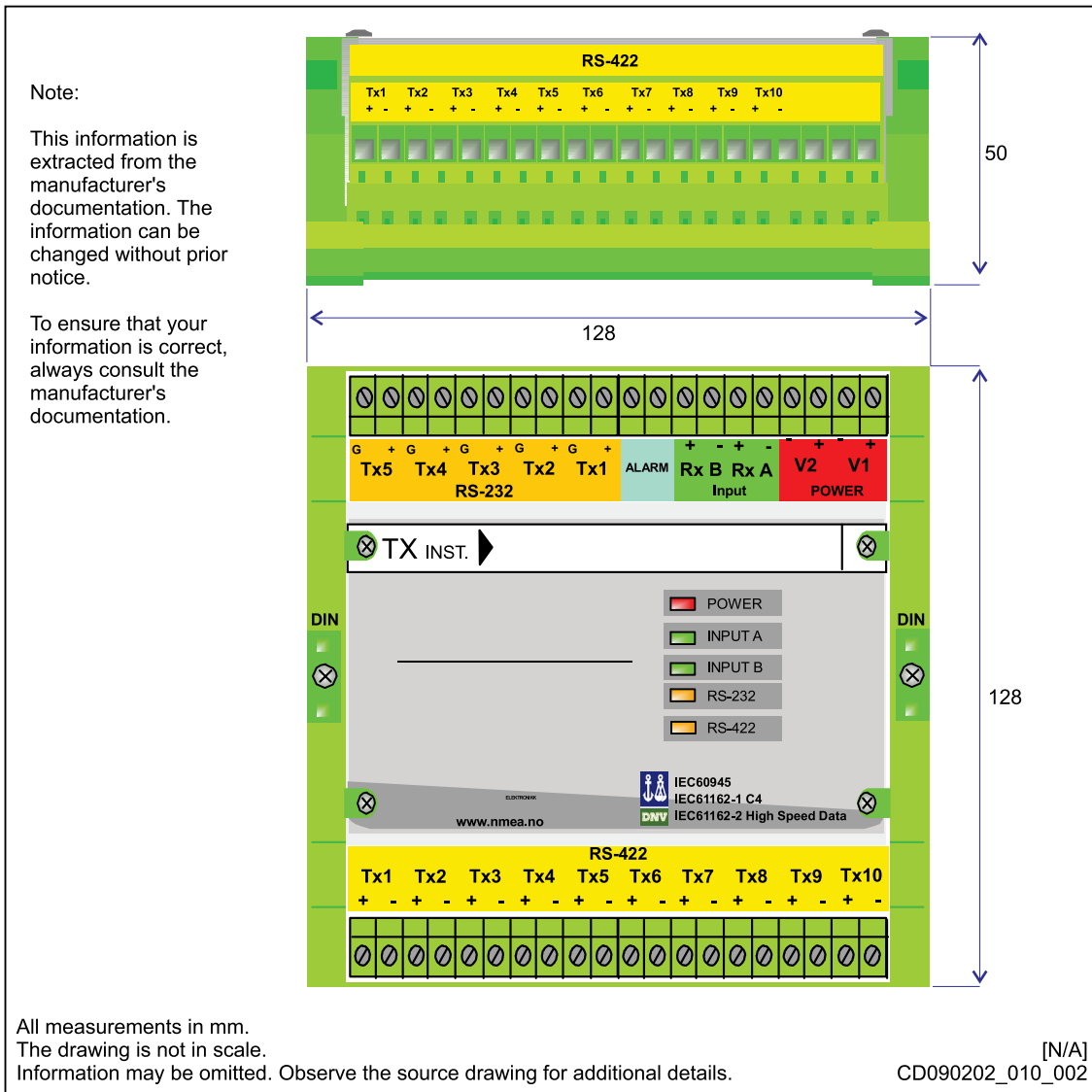

#### Related topics

[Serial line splitter Øverland UPC-5000P, page 122](#)

[Cable plans, page 88](#)

[Cable layout and interconnections, page 85](#)

# Setting up the EK80 in a synchronized system

## Topics

[About synchronization, page 126](#)

[Synchronization modes, page 127](#)

[Synchronization sequences, page 128](#)

[Synchronization using Clear To Send \(CTS\) and Request To Send \(RTS\) signals, page 129](#)

[Synchronization using the Auxiliary socket on the transceiver, page 129](#)

[Synchronizing the EK80 by means of a serial port, page 131](#)

[Synchronizing the EK80 by means of the Auxiliary port, page 134](#)

## About synchronization

Whenever more than one hydroacoustic system are installed on a vessel, interference may occur. With only two systems, interference can be avoided if one of the hydroacoustic systems can control the transmissions of the other system. If multiple systems are used, they can be connected to a common synchronisation system that controls all the transmissions.

In physics, interference is the phenomenon in which two waves superpose each other to form a resultant wave of greater or lower amplitude. Interference usually refers to the interaction of waves that are correlated or coherent with each other, either because they come from the same source or because they have the same or nearly the same frequency. Interference effects can be observed with all types of waves, for example, light, radio, acoustic, surface water waves or matter waves.

*[https://en.wikipedia.org/wiki/Wave\\_interference](https://en.wikipedia.org/wiki/Wave_interference) — April 2016*

The Simrad EK80 may be set up to be synchronized with other hydroacoustic instruments. Synchronization is necessary to prevent several hydroacoustic systems from transmitting simultaneously. Individual transmission is often a necessity to prevent interference.

## Related topics

[Setting up the EK80 in a synchronized system, page 126](#)

[Cable layout and interconnections, page 85](#)



## Synchronization modes

The purpose of the synchronization modes are to set up the EK80 to operate alone, or as a "master" or "slave" in a synchronized system.

Whenever more than one hydroacoustic system is installed on a vessel, interference may occur. To avoid interference, you have these options:

- The systems are all connected to a common synchronization system.
- One of the acoustic systems is set up as "master", and controls the transmissions on the other systems.

The EK80 offers functionality for remote transmit synchronization. It can be set up to operate in either *Master* or *Slave* mode.

The following synchronization modes are available:

- *Stand-alone*

Synchronization is turned off. This synchronization mode is used if the EK80 is working by itself and with no synchronization required. This is the default setting. The EK80 operates using its internal ping interval parameters, independent of any trigger signals arriving at the synchronization port.

The **Synchronization Delay** setting is not applicable when synchronization is switched off.

- *Master*

*Master* mode is used if the EK80 is going to act as the controlling unit in a synchronized system. The peripheral hydroacoustic system(s) are only permitted to transmit when enabled by the EK80. When *Master* mode is selected, the EK80 will run using its internal ping interval parameters and send trigger signals to the peripheral system(s).

This mode is unavailable if you set **Synchronization Port** to *Transceiver Auxiliary Port*.

- *Slave*

*Slave* mode is used if the EK80 is going to transmit only when permitted by a peripheral system. When *Slave* mode is selected, the EK80 does not transmit ("ping") unless an external trigger appears on the chosen synchronization port. The peripheral system may be any other hydroacoustic product (for example an echo sounder or sonar), or even a dedicated synchronization system.

### Related topics

[Setting up the EK80 in a synchronized system, page 126](#)

[Cable layout and interconnections, page 85](#)

## Synchronization sequences

In many applications, the synchronisation interface is based on an RS-232 serial port. When you connect two systems for synchronisation using Clear to Send (CTS) and Request to Send (RTS), one system must set up as a "Master" and the other as a "Slave". When the EK80 is "Master" in a system, the synchronization can either take place in *Free running mode*, or in *Wait for slave mode*.

### **Slave mode**

When the EK80 is set up in *Slave mode*, it must receive a trigger signal from a peripheral system every time the EK80 is going to transmit. This trigger signal is connected to a serial port on the Processor Unit, and the *Clear To Send (CTS)* pin is used to give the EK80 an "event" message. The message is processed by the EK80 software, and it will (if the previous ping has been finished) start the ping sequence.

As an acknowledgement to the synchronization trigger, the EK80 sets the *Ready To Send (RTS)* signal to a logic "low" before transmitting. This indicates that the EK80 is "busy".

Once the transmission and reception sequence ends, the EK80 sets the *Ready To Send (RTS)* signal to a logic "high" to indicate that it is ready for the next ping.

### **Master mode**

When the EK80 is "Master" in a system, the synchronization can either take place in *Free running mode*, or in *Wait for slave mode*.

- Synchronization in *Free running mode*

When in *Free running mode*, the EK80 will ping as fast as possible, setting its Ready to Send (RTS) signal to a logic "high" at start of each ping, and back to logic "low" at the end of the ping. The "Slave" system is triggered when the Ready to Send (RTS) signal goes from "low" to "high".

- Synchronization in *Wait for slave mode*

When in *Wait for slave mode*, the EK80 will wait for a logic "high" Clear to Send (CTS) signal from the "Slave" system before it starts a new ping sequence. This is the "ready to ping" acknowledge from the "Slave" system.

### Note

---

*If you use the EK80 as "Master" to control two "Slave" systems, you must connect a single cable (plus ground) from the Ready to Send (RTS) output on the Master system to the Clear to Send (CTS) input on both "Slave" systems. The return from the Ready to Send (RTS) outputs on the "Slave" systems can not be connected.*

---

### **Related topics**

[Setting up the EK80 in a synchronized system, page 126](#)

[Cable layout and interconnections, page 85](#)

## Synchronization using Clear To Send (CTS) and Request To Send (RTS) signals

In many applications, the synchronisation interface is based on an RS-232 serial port. Only the Clear to Send (CTS) and Request to Send (RTS) connections of the RS-232 interface are then used.

According to the standard specifications for RS-232, an output must generate a voltage level of +5 to +15 VDC (logic "low"), and -5 to -15 VDC (logic "high") into a load of 3 to 7 k $\Omega$ . An RS-232 receiver must present a 3 to 7 k $\Omega$  load, converting an input of +3 to +25 VDC to logic "low", and an input of -3 to -25 VDC to logic "high". With a positive trigger pulse, the offset voltage does not have any significance. Even small variations (flutter) over and below 0 VDC will not trigger the interface.

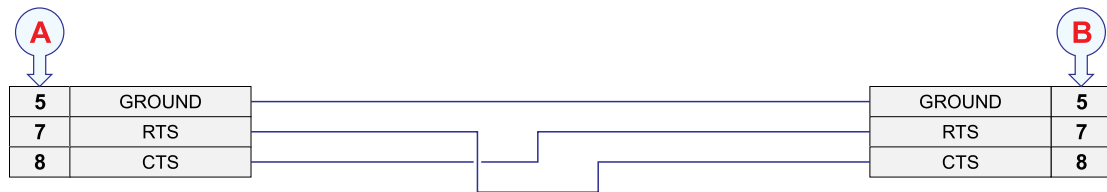

- A Local connection
- B Connection on remote device
- C Female 9-pin D-Subminiature connector
- D Male 9-pin D-Subminiature connector

Note \_\_\_\_\_

*RS-422 communication ports can not be used for synchronization purposes. The port you wish to use must be set to RS-232.*

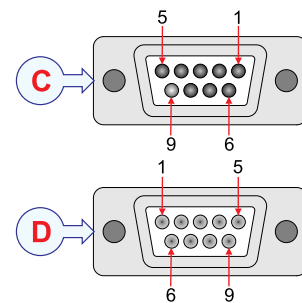

### Related topics

[Setting up the EK80 in a synchronized system, page 126](#)  
[Cable layout and interconnections, page 85](#)

## Synchronization using the Auxiliary socket on the transceiver

The AUXILIARY socket on the Wide Band Transceiver (WBT) offers a "trigger input" signal for transmit synchronisation from an external system. This synchronization method may be more stable than the traditional CTS/RTS connection to a serial port.

Normally, the EK80 transmits as soon as it is ready for the next "ping". When transmit synchronization on the AUXILIARY socket is enabled, the transmission is delayed until a trigger pulse is detected on the input. The input trigger pulse must be a low-to-high transition. "Low" level must be less than 0.7 V, while "High" must be above 2.8 V. "High" level must not exceed 15 V! Once the trigger pulse is detected, the EK80 will initiate transmission on all transceivers and frequencies.

The synchronization output on the **AUXILIARY** socket offers a "high" pulse (5 V, 100Ω) that stays "high" during the entire "ping" cycle. The pulse is always there no matter which synchronization settings you make in the user interface. The output can be used to synchronize other hydrographic systems with the EK80 as "master".

The socket fits a Conxall 7-pin Mini-Con-X<sup>®</sup> shielded plug. The connections are made on pins 2, 3 and 5. The plug can be ordered from the manufacturer or purchased from Kongsberg Maritime. Use part number 387563.

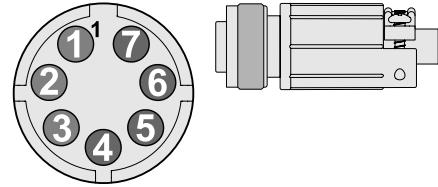

- **Manufacturer:** Switchcraft Conxall
- **Manufacturer's website:** <http://www.conxall.com>

<b>Pin number</b>	<b>1</b>	<b>2</b>	<b>3</b>	<b>4</b>
<b>Signal</b>	Future use	Synchronization Output	Synchronization Input	Future use
<b>Pin number</b>	<b>5</b>	<b>6</b>	<b>7</b>	
<b>Signal</b>	Digital ground	Not used	Not used	

The parameters on the **Synchronization** page allow you to choose which communication port to use for the physical connection to the external system, and which synchronization mode to use. The **Synchronization** page is located in the **Installation** dialog box on the **Setup** menu.

**Note**

---

*If you use more than one Wide Band Transceiver (WBT) in your EK80 system, all synchronization input signals to the **AUXILIARY** ports must be provided by the same source. Individual synchronization of a single Wide Band Transceiver (WBT) is not supported.*

*If you use more than one computer in your EK80 system, the synchronization inputs to the **AUXILIARY** ports can not be used. This functionality is not supported.*

---

**Related topics**

- [Setting up the EK80 in a synchronized system, page 126](#)
- [Cable layout and interconnections, page 85](#)

## Synchronizing the EK80 by means of a serial port

If you want to use the EK80 as a master or slave in a synchronized system, you must set it up for such operation. To do this, you must select which communication port to use for the synchronization interface, and you must select the requested synchronization mode.

### Prerequisites

You have an RS2-232 interface port on your Processor Unit that allows you to use the CTS/RTS connections.

For "slave" operation, a remote system (for example *K-Sync*) must be available to provide trigger pulses. For "master" operation, a remote hydroacoustic system (sonar, echo sounder) is connected. This remote system must be set up in "slave" mode.

You must be equipped with a standard set of tools. This tool set must comprise the normal tools for electronic and electromechanical tasks. This includes different screwdriver types, pliers, spanners, a cable stripper, a soldering iron, etc. Each tool must be provided in various sizes. We recommend that all tools are demagnetized to protect your equipment.

### Context

Whenever more than one hydroacoustic system is installed on a vessel, interference may occur. To avoid interference, you have these options:

- The systems are all connected to a common synchronization system.
- One of the acoustic systems is set up as "master", and controls the transmissions on the other systems.

The EK80 offers functionality for remote transmit synchronization. It can be set up to operate in either *Master* or *Slave* mode.

### Tip

---

*The Wide Band Transceiver (WBT) offers an AUXILIARY port that can be used for synchronisation purposes. This synchronization method may be more stable than the traditional CTS/RTS connection to a serial port.*

*The Synchronization Delay functionality is unavailable if you use the AUXILIARY port on your Wide Band Transceiver (WBT) to synchronize the EK80.*

---

When you work in the **Installation** dialog box, you must always select **Apply** to save the changes made on a page. You must do this before you continue working on a different page.

### Procedure

- 1 Connect the synchronization cable from the remote system to an available communication port on your Processor Unit.

This is described in the *Cable layout and interconnections* chapter. Observe the applicable requirements related to cabling. Make sure that the total length of the

serial line cable does not exceed approximately 50 meters. If a longer cable is required, you may need to use buffer amplifiers.

If the Processor Unit is not fitted with a suitable serial line connector, use a USB-to-serial converter. Several types are commercially available. Note that most USB-to-serial converters will introduce some latency. They may also introduce jitter in the communication. The amount of jitter depends on the quality of the converter.

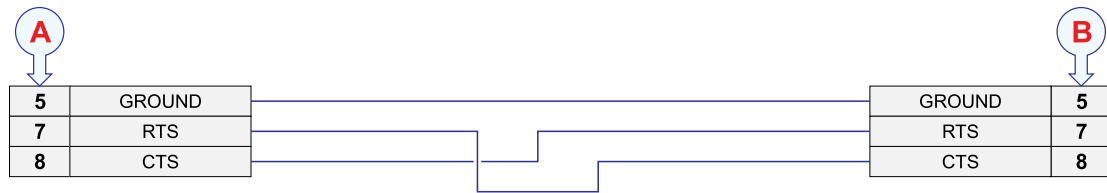

**A** Local connection on the Processor Unit

**B** Connection on remote device

- 2 Turn on the EK80, and set it to normal use.
- 3 Open the **Setup** menu.
- 4 On the **Setup** menu, select **Installation**.

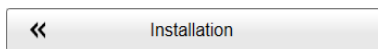

Observe that the **Installation** dialog box opens. This dialog box contains a number of pages selected from the menu on the left side.

- 5 On the left side of the **Installation** dialog box, select **Synchronization**.
- 6 Select **Synchronization Mode**.

- *Stand-alone*

Synchronization is turned off. This synchronization mode is used if the EK80 is working by itself and with no synchronization required. This is the default setting. The EK80 operates using its internal ping interval parameters, independent of any trigger signals arriving at the synchronization port.

The **Synchronization Delay** setting is not applicable when synchronization is switched off.

- *Master*

*Master* mode is used if the EK80 is going to act as the controlling unit in a synchronized system. The peripheral hydroacoustic system(s) are only permitted to transmit when enabled by the EK80. When *Master* mode is selected, the EK80 will run using its internal ping interval parameters and send trigger signals to the peripheral system(s).

This mode is unavailable if you set **Synchronization Port** to *Transceiver Auxiliary Port*.

- *Slave*

*Slave* mode is used if the EK80 is going to transmit only when permitted by a peripheral system. When *Slave* mode is selected, the EK80 does not transmit ("ping") unless an external trigger appears on the chosen synchronization port. The peripheral system may be any other hydroacoustic product (for example an echo sounder or sonar), or even a dedicated synchronization system.

7 Select **Synchronization Delay**.

This delay parameter is used differently depending on the chosen synchronization mode.

- *Stand-alone*

The **Synchronization Delay** setting is not applicable when synchronization is switched off.

- *Master*

In *Master* mode, the EK80 waits for the delay time after the external trigger signal has been sent to the slaves before transmitting the ping. This is often referred to as a *pre-trigger*.

**Note** \_\_\_\_\_

*This delay will only work when the synchronization is set up using a serial port.*

---

- *Slave*

In *Slave* mode, the EK80 waits for the delay time after the external trigger signal has arrived before transmitting the ping. This is often referred to as a *post-trigger*.

8 From the list of ports available, select **Synchronization Port**.

This is the interface port currently used to transmit or receive synchronization signals. It must be an RS-232 serial port. Since the synchronization function only uses the *Request To Send (RTS)* and *Clear To Send (CTS)* signals on a serial port, you can use a port that is already used for other purposes. For the same reason, you do not need to define any baud rate.

9 At the bottom of the page, select **Apply** to save your settings.

10 Continue your work in the **Installation** dialog box, or select **OK** to close it.

**Related topics**

[Setting up the EK80 in a synchronized system, page 126](#)

[Cable layout and interconnections, page 85](#)

[Interfacing peripheral equipment, page 228](#)

## Synchronizing the EK80 by means of the Auxiliary port

The Wide Band Transceiver (WBT) offers an **AUXILIARY** port that can be used for synchronisation purposes. This synchronization method may be more stable than the traditional CTS/RTS connection to a serial port.

### Prerequisites

Unless the physical connections already have been made with a suitable cable, you need the following items:

- Cable
- Plug

You must be equipped with a standard set of tools. This tool set must comprise the normal tools for cable installation tasks. This includes different screwdriver types, pliers, spanners, a cable stripper, a soldering iron, etc. Each tool must be provided in various sizes. We recommend that all tools are demagnetized to protect your equipment. Depending on the tasks at hand, additional tools may be required.

### Context

The **AUXILIARY** socket on the Wide Band Transceiver (WBT) can be used to interface an external synchronization system.

The socket fits a Conxall 7-pin Mini-Con-X<sup>®</sup> shielded plug. The connections are made on pins 2, 3 and 5. The plug can be ordered from the manufacturer or purchased from Kongsberg Maritime. Use part number 387563.

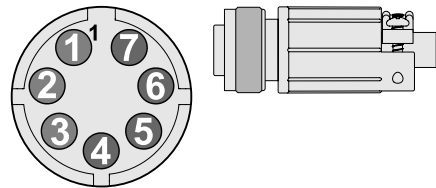

- **Manufacturer:** Switchcraft Conxall
- **Manufacturer's website:** <http://www.conxall.com>

<b>Pin number</b>	<b>1</b>	<b>2</b>	<b>3</b>	<b>4</b>
<b>Signal</b>	Future use	Synchronization Output	Synchronization Input	Future use
<b>Pin number</b>	<b>5</b>	<b>6</b>	<b>7</b>	
<b>Signal</b>	Digital ground	Not used	Not used	

The parameters on the **Synchronization** page allow you to choose which communication port to use for the physical connection to the external system, and which synchronization mode to use. The **Synchronization** page is located in the **Installation** dialog box on the **Setup** menu.



**Note**

*If you use more than one Wide Band Transceiver (WBT) in your EK80 system, all synchronization input signals to the **AUXILIARY** ports must be provided by the same source. Individual synchronization of a single Wide Band Transceiver (WBT) is not supported.*

*If you use more than one computer in your EK80 system, the synchronization inputs to the **AUXILIARY** ports can not be used. This functionality is not supported.*

*The **Synchronization Delay** functionality is unavailable if you use the **AUXILIARY** port on your Wide Band Transceiver (WBT) to synchronize the EK80.*

---

**Procedure**

- 1 Connect the dedicated cable from the Wide Band Transceiver (WBT) to the external synchronisation system.

This is described in the *Cable layout and interconnections* chapter. Observe the applicable requirements related to cabling.

- 2 Turn on the EK80, and set it to normal use.
- 3 Open the **Setup** menu.
- 4 On the **Setup** menu, select **Installation**.



Observe that the **Installation** dialog box opens. This dialog box contains a number of pages selected from the menu on the left side.

- 5 On the left side of the **Installation** dialog box, select **Synchronization**.
- 6 From the list of ports available, select **Transceiver Auxiliary Port**.
- 7 Observe that when **Transceiver Auxiliary Port** is selected, only *Slave* synchronization mode is permitted.

*Slave* mode is used if the EK80 is going to transmit only when permitted by a peripheral system. When *Slave* mode is selected, the EK80 does not transmit ("ping") unless an external trigger appears on the chosen synchronization port. The peripheral system may be any other hydroacoustic product (for example an echo sounder or sonar), or even a dedicated synchronization system.

- 8 At the bottom of the page, select **Apply** to save your settings.
- 9 Continue your work in the **Installation** dialog box, or select **OK** to close it.

**Related topics**

[Setting up the EK80 in a synchronized system, page 126](#)

[Cable layout and interconnections, page 85](#)

[Interfacing peripheral equipment, page 228](#)

## Cable drawings and specifications

### Topics

[AC power cable using IEC C13 inline socket, page 137](#)

[Ground cable, page 139](#)

[RS-232 serial line connection using three wires, page 140](#)

[RS-232 serial line connection using five wires, page 141](#)

[RS-422 serial line connection using five wires, page 142](#)

[RS-232 used as synchronization trigger \(input or output\), page 143](#)

[RS-485 serial line connection using two or four wires, page 144](#)

[Moxa CP114EL-I Serial line adapter, page 145](#)

[RJ45 High speed Ethernet cable \(1000Base-t\), page 147](#)

[Battery power cable, page 148](#)

[K-Sync interface to generic RS-232 synchronization input, page 148](#)

[Simrad TU40 interface to generic RS-232 synchronization input, page 151](#)

[Auxiliary connector for synchronization, page 153](#)

[Single beam low power transducer connection to a circular transducer socket, page 154](#)

[Split beam transducer connection to an Amphenol socket, page 156](#)

[Split beam transducer connection for single beam use on an Amphenol socket, page 159](#)

[Burton underwater connectors on split beam transducers for deep water, page 162](#)

[About serial lines, page 164](#)

## AC power cable using IEC C13 inline socket

This cable is used to connect any unit or device to AC mains supply. It is commercial, and normally used for 115 and 230 VAC. The inline socket and plug comply to the IEC60320 standard.



- A IEC13 line socket - may be fitted with a locking device
- B CEE 7/7 male power plug
- C Live (normally identified with Blue insulation)
- D Neutral (normally identified with Brown insulation)
- E Ground (normally identified with Yellow or Yellow/Green insulation)

A standard commercial AC mains cable is used. The power cable is normally terminated with an female IEC C13 inline socket. The AC mains end is terminated in an AC connector suitable for the local standard and/or the output sockets on an uninterruptible power supply (UPS). If this is not the case, you must replace the AC connector.

The typical cable length is between 1,5 and 2 meters. If this is too short you must use an extension cable (not recommended), mount a new power outlet within range, or make your own power cable with sufficient length. If you use an uninterruptible power supply (UPS), you can also move the UPS to a different location within range.

### Note

*There are substantial differences between American and British nomenclature related to power plugs and sockets. Observe local standards and regulations.*

### **Minimum cable requirements**

- **Conductors:** 2 x 1.5 mm<sup>2</sup> + 1.5 mm<sup>2</sup> Ground
- **Screen:** None
- **Voltage:** 750 V
- **Maximum outer diameter:** Defined by the plugs and/or the cable gland

### **Related topics**

[Cable drawings and specifications, page 136](#)

[Cable layout and interconnections, page 85](#)

## Ground cable

Correct grounding is essential for safe operation and maximum performance.

A *Ground tag on unit*

B *Vessel ground*

The ground connection is made using a thick stranded (or yellow/green) cable making a solid connection between the cabinet and the bulkhead. It is normally provided with a green/yellow colour. The grounding cable must be connected to vessel ground in the fuse box, or other common grounding point.

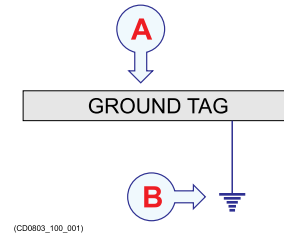

### Minimum cable requirements

- **Conductors:** 1 x 6 mm<sup>2</sup>
- **Screen:** None
- **Voltage:** 60 V
- **Maximum outer diameter:** Not applicable

### Related topics

[Cable drawings and specifications, page 136](#)

[Cable layout and interconnections, page 85](#)

## RS-232 serial line connection using three wires

An RS-232 serial line connection using three (3) wires and NMEA datagrams is a common way to connect the EK80 to external devices.

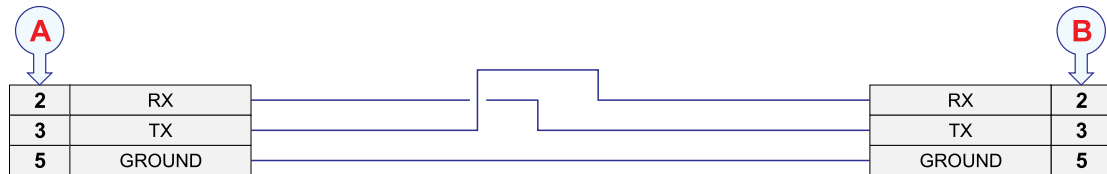

- A *Local connection*
- B *Connection on remote device*
- C *Female 9-pin D-Subminiature connector*
- D *Male 9-pin D-Subminiature connector*

Unless otherwise specified, this cable must be provided by the installation shipyard. Note that this cable does not support all the signals in the standard RS-232 specification.

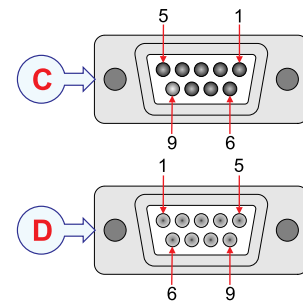

### Minimum cable requirements

- **Conductors:** 2 x 4 x 0.5 mm<sup>2</sup>
- **Screen:** Overall braided
- **Voltage:** 60 V
- **Maximum outer diameter:** Defined by the plugs and/or the cable gland

If you need to install a very long cable, increase the cross section.

### Related topics

- [Cable drawings and specifications, page 136](#)
- [Cable layout and interconnections, page 85](#)

## RS-232 serial line connection using five wires

An RS-232 serial line connection using five (5) wires and NMEA datagrams is a common way to connect the EK80 to external devices.

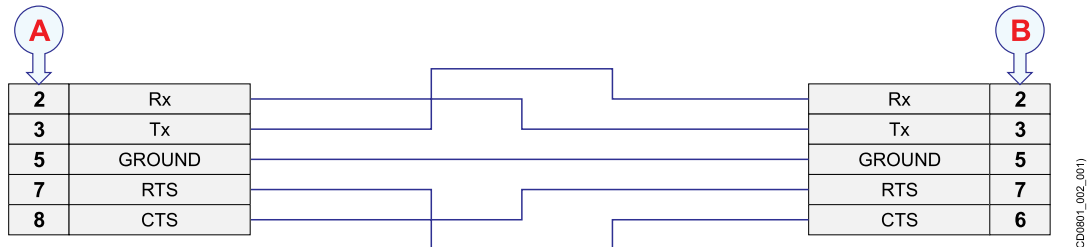

- A *Local connection*
- B *Connection on remote device*
- C *Female 9-pin D-Subminiature connector*
- D *Male 9-pin D-Subminiature connector*

Unless otherwise specified, this cable must be provided by the installation shipyard. Note that this cable does not support all the signals in the standard RS-232 specification.

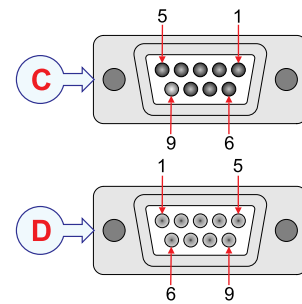

### Minimum cable requirements

- **Conductors:** 2 x 4 x 0.5 mm<sup>2</sup>
- **Screen:** Overall braided
- **Voltage:** 60 V
- **Maximum outer diameter:** Defined by the plugs and/or the cable gland

If you need to install a very long cable, increase the cross section.

### Related topics

[Cable drawings and specifications, page 136](#)

[About serial lines, page 164](#)

[Cable layout and interconnections, page 85](#)

## RS-422 serial line connection using five wires

An RS-422 serial line connection can transmit data at rates as high as 10 million bits per second, and may be sent on cables as long as 1500 meters.

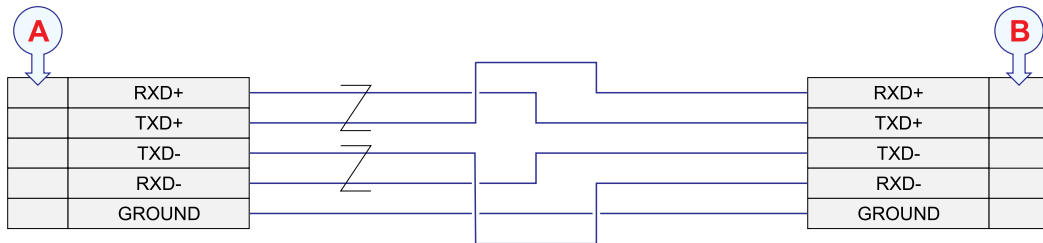

A *Local connection*

B *Connection on remote device*

For more information, refer to the end-user documentation provided by the manufacturer.

C *Female 9-pin D-Subminiature connector*

D *Male 9-pin D-Subminiature connector*

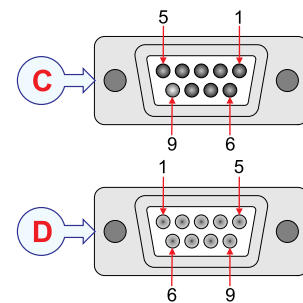

Unless otherwise specified, this cable must be provided by the installation shipyard.

### Minimum cable requirements

- **Conductors:** 2 x 5 x 0.5 mm<sup>2</sup>
- **Screen:** Overall braided
- **Voltage:** 60 V
- **Maximum outer diameter:** Defined by the plugs and/or the cable gland

If you wish to use RS-422 or RS-485 serial communication, use a cable with twisted pairs. If you need to install a very long cable, increase the cross section.

### Related topics

[Cable drawings and specifications, page 136](#)

[About serial lines, page 164](#)

[Cable layout and interconnections, page 85](#)



## RS-232 used as synchronization trigger (input or output)

An RS-232 serial line connection using the Request To Send (RTS) and Clear To Send (CTS) signals is common way to connect the EK80 to external devices for synchronization purposes.

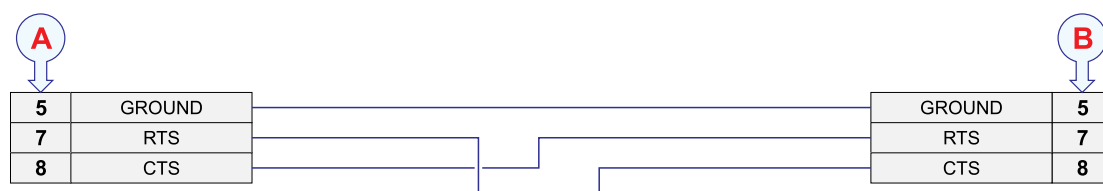

- A Local connection
- B Connection on remote device
- C Female 9-pin D-Subminiature connector
- D Male 9-pin D-Subminiature connector

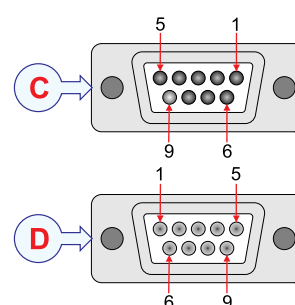

This cable takes the control signals on a RS-232 serial line, and uses these as an external trigger. It provides interface with any peripheral unit that requires or controls transmit/receive synchronization. Note that this cable does not support all the signals in the standard RS-232 specification.

### Note

*This synchronization method can only be used with RS-232 communication. You can only connect two systems together.*

Unless otherwise specified, this cable must be provided by the installation shipyard.

### Minimum cable requirements

- **Conductors:** 2 x 4 x 0.5 mm<sup>2</sup>
- **Screen:** Overall braided
- **Voltage:** 60 V
- **Maximum outer diameter:** Defined by the plugs and/or the cable gland

If you need to install a very long cable, increase the cross section.

### Related topics

[Cable drawings and specifications, page 136](#)

[About serial lines, page 164](#)

[Cable layout and interconnections, page 85](#)

## RS-485 serial line connection using two or four wires

An RS-485 serial line connection using two or four wires is common way to connect the EK80 to external devices. This format is recommended if the serial cable needs to be very long.

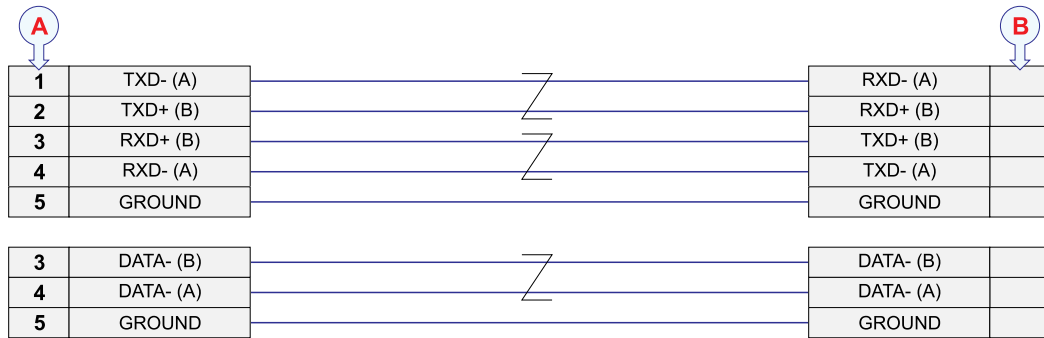

- A *Local connection to the serial adapter*
- B *Connection on remote device (For more information, refer to the end-user documentation provided by the manufacturer.)*
- C *Female 9-pin D-Subminiature connector*
- D *Male 9-pin D-Subminiature connector*

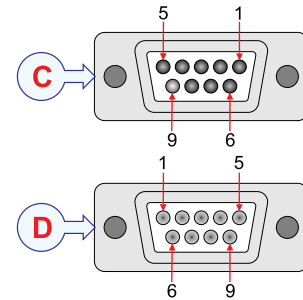

Unless otherwise specified, this cable must be provided by the installation shipyard.

### Minimum cable requirements

- **Conductors:** 2 x 5 x 0.5 mm<sup>2</sup>
- **Screen:** Overall braided
- **Voltage:** 60 V
- **Maximum outer diameter:** Defined by the plugs and/or the cable gland

Use a cable with twisted pairs. If you need to install a very long cable, increase the cross section.

### Related topics

- [Cable drawings and specifications, page 136](#)
- [About serial lines, page 164](#)
- [Cable layout and interconnections, page 85](#)

## Moxa CP114EL-I Serial line adapter

The Processor Unit is equipped with a Moxa CP114EL-I serial adapter board. The board provides four serial lines. The serial lines are connected using a large D-Subminiature connector on the rear side of the Processor Unit.

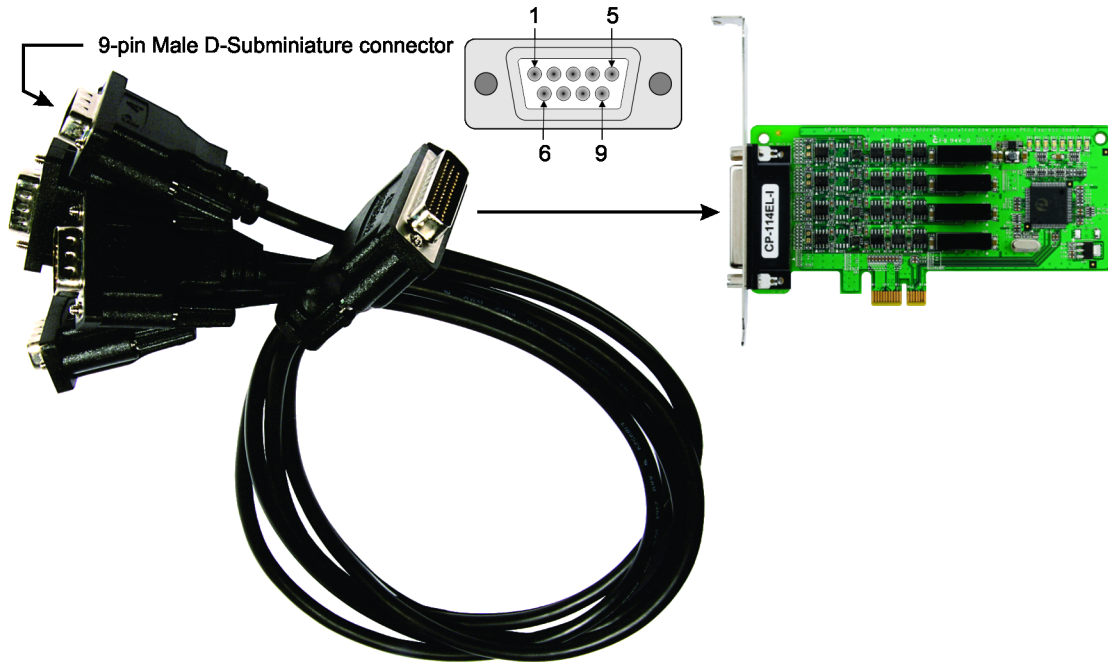

The Moxa CP114EL-I serial adapter supports RS-232, RS-422 and RS-485 (both 2 and 4-wire). The connections to the board are made using a converter cable with four 9-pin male D-subminiature connectors. The converter cable is supplied with the Processor Unit.

- **Manufacturer:** Moxa
- **Manufacturer's website:** <https://www.moxa.com>



Unless otherwise specified, this cable must be provided by the installation shipyard. If you wish to use RS-422 or RS-485 serial communication, use a cable with twisted pairs.

### Note

*Observe that long runs of unshielded cable will pick up noise easily. This is because the RS-232 signals are not balanced.*

Maximum length for an RS-232 serial cable is typically 60 meters with 2400 bps data rate, however this depends on the cable quality. Always check the cable manufacturers specifications for the actual "shunt capacitance". A common figure is 47.5 pF/m, which gives a maximum cable length of about 50 meters.

Even though a standard exist for RS-232 pin configuration, certain manufacturer may still choose their own connector pins for the various signals used. In order to make the

RS-232 connection to your peripheral device work properly, you must always consult the relevant instructions provided by the device manufacturer.

### Pin configuration

Moxa CP114EL-I connectors / Adapter cable				
Pin	RS-232	RS-422	RS-485 (4-wire)	RS-485 (2-wire)
1	DCD	TXD-(A)	TXD-(A)	
2	RxD	TXD+(B)	TXD+(B)	
3	TxD	RXD+(B)	RXD+(B)	Data-(B)
4	DTR	RXD-(A)	RXD-(A)	Data-(A)
5	Ground	Ground	Ground	Ground
6	DSR			
7	RTS			
8	CTS			
9				

### Minimum cable requirements

- **Conductors:** 2 x 5 x 0.5 mm<sup>2</sup>
- **Screen:** Overall braided
- **Voltage:** 60 V
- **Maximum outer diameter:** Defined by the plugs and/or the cable gland

If you wish to use RS-422 or RS-485 serial communication, use a cable with twisted pairs. If you need to install a very long cable, increase the cross section.

### Related topics

[Cable drawings and specifications, page 136](#)

[About serial lines, page 164](#)

[Cable layout and interconnections, page 85](#)

## RJ45 High speed Ethernet cable (1000Base-t)

Most high speed data connections between the EK80 system units are made using Ethernet cables. These cables may also be used between the EK80 and peripheral equipment.



A *Local Ethernet connection*

B *Connection on external network device*

Ethernet cables are available commercially in different lengths, colours and categories. Normally, CAT-5E and CAT-6 cables are used in local area networks with bandwidths exceeding 100 Mbit.

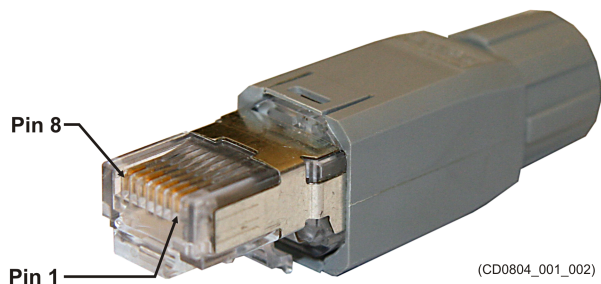

### Minimum cable requirements

It is very important that high-quality Ethernet cables are used. You must use CAT-5E quality or better. If you use cables with lower bandwidth capacity you will reduce the EK80 performance.

### Related topics

[Cable drawings and specifications, page 136](#)

[Cable layout and interconnections, page 85](#)

## Battery power cable

A suitable cable must be provided if you wish to power the Wide Band Transceiver (WBT) from a battery.

The power socket is mounted on the rear panel of the transceiver. The socket fits a Conxall 4-pin Mini-Con-X® shielded plug. One spare plug is included with the EK80 delivery. You can use this plug if you wish to operate the transceiver from a battery. The plug can be ordered from the manufacturer or purchased from Kongsberg Maritime. Use part number 390616.

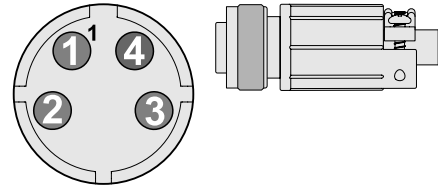

- **Manufacturer:** Switchcraft Conxall
- **Manufacturer's website:** <http://www.conxall.com>
- **True manufacturer's part number:** SF6382-4SG-520

### Pin configuration

Pin number	1	2	3	4
Voltage	+12 VDC	0 VDC	0 VDC	+12 VDC

### Minimum cable requirements

- **Conductors:** 2 x 1.5 mm<sup>2</sup>
- **Screen:** None
- **Voltage:** 60 V
- **Maximum outer diameter:** Not applicable

### Related topics

[Cable drawings and specifications, page 136](#)

[Cable layout and interconnections, page 85](#)

## K-Sync interface to generic RS-232 synchronization input

For transmission synchronization purposes, the K-Sync will interface a generic RS-232 serial line communication port using the CTS (Clear To Send) and RTS (Request To Send) signals.

The synchronized product is connected to the IO Module inside the K-Sync Synchronizing Unit. Each IO Module in the K-Sync Synchronizing Unit provides six connectors and a configuration board for physical adjustments of the communication parameters.

Pin number	Signal	Signal description
1	Trigger Out	This signal is transmitted to the system that needs to be synchronized. Trigger Out allows the system to transmit ("ping").
2	Ground	Mandatory! This ground is connected to pin 5 inside the IO Module.
3	RTT	Ready to Transmit: Ready to Transmit (RTT) is a return signal from the hydroacoustic system that is synchronized. The Ready to Transmit (RTT) signal means that the hydroacoustic system is ready for the next trigger.
4	Trigger In	This signal is received from the system that needs to be synchronized. Trigger In is "active" while the system is transmitting.
5	Ground	Mandatory! This ground is connected to pin 2 inside the IO Module.
6	Not used	

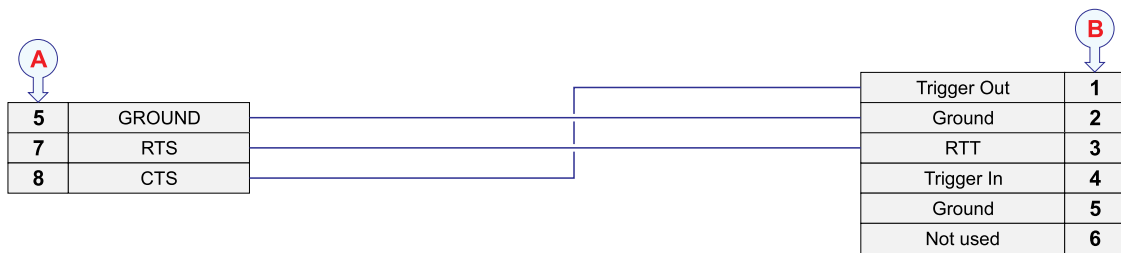

**A** Local connection on the Processor Unit

**B** Connections on the K-Sync IO Module

**A** *Connectors 1 through 6 as indicated by the arrows.*

Note that each of the two connector elements can be pulled out of the IO Module for easy access.

**B** *Configuration board*

Unless otherwise specified, this cable must be provided by the installation shipyard.

**Minimum cable requirements**

- **Conductors:** 2 x 5 x 0.5 mm<sup>2</sup>
- **Screen:** Overall braided
- **Voltage:** 60 V
- **Maximum outer diameter:** Defined by the plugs and/or the cable gland

If you need to install a very long cable, increase the cross section.

**Related topics**

[Cable drawings and specifications, page 136](#)

[Cable layout and interconnections, page 85](#)

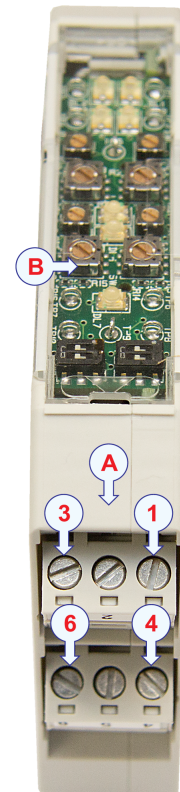



## Simrad TU40 interface to generic RS-232 synchronization input

For transmission synchronization purposes, the Simrad TU40 will interface a generic RS-232 serial line communication port using the CTS (Clear To Send) and RTS (Request To Send) signals.

The NotUsed provides one output and one input for each hydroacoustic system that needs to be synchronized. Each system is connected to the IO Module inside the NotUsed. Each IO Module in the NotUsed comprises an analog input module, a digital output module and a solid state relay module.

Pin	Signal	Trigger Unit	Signal description
Screen(Green)	Screen	A	Cable screen
Input	RTT	B	Ready to Transmit: Ready to Transmit (RTT) is a return signal from the hydroacoustic system that is synchronized. The Ready to Transmit (RTT) signal means that the hydroacoustic system is ready for the next trigger.
Ground	Ground	C	Signal ground
Output	Trigger Out	D	This signal is transmitted to the system that needs to be synchronized. Trigger Out allows the system to transmit ("ping").

Trigger Unit = Connections on the terminal block in the Trigger Unit

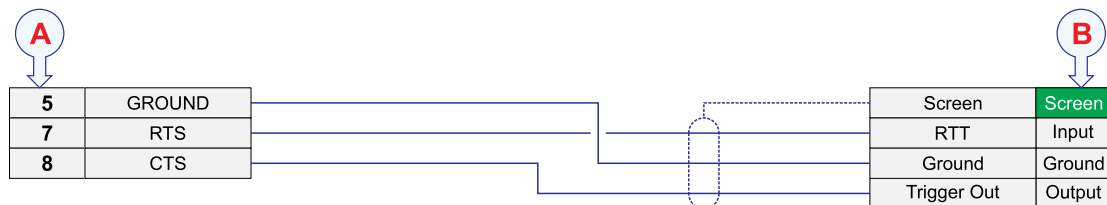

**A** Local connection on the Processor Unit

**B** Connections on the terminal block in the Trigger Unit (From left)

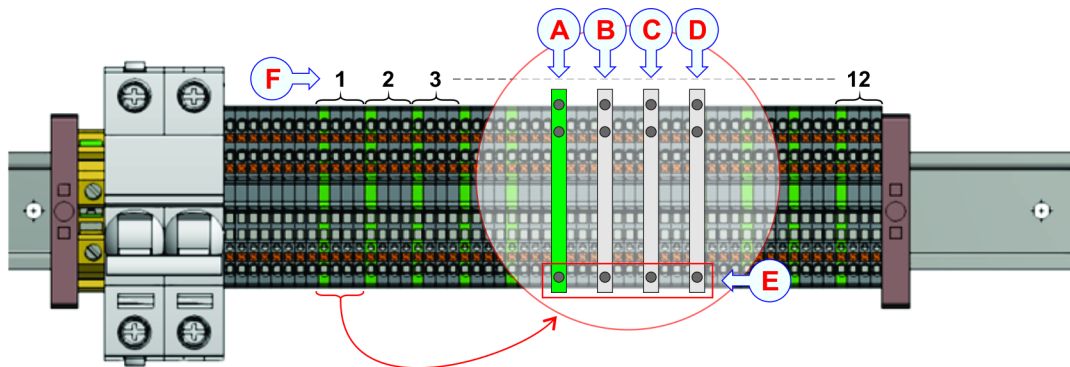

- A *Screen (Cable screen) (Green)*
- B *Input (Ready to Transmit (RTT))*
- C *Ground (Signal ground)*
- D *Output (Trigger Out)*
- E *Make the connections here.*
- F *Channels (From left)*

### **Minimum cable requirements**

Unless otherwise specified, this cable must be provided by the installation shipyard. If you need to install a very long cable, increase the cross section.

- **Conductors:** 2 x 2 x 0.5 mm<sup>2</sup>
- **Screen:** Overall braided
- **Voltage:** 60 V
- **Maximum outer diameter:** Defined by the plugs and/or the cable gland

### **Related topics**

[Cable drawings and specifications, page 136](#)

[Cable layout and interconnections, page 85](#)

## Auxiliary connector for synchronization

The Wide Band Transceiver (WBT) is fitted with a dedicated socket for auxiliary interfaces.

The AUXILIARY socket on the Wide Band Transceiver (WBT) can be used to interface an external synchronization system.

The socket fits a Conxall 7-pin Mini-Con-X® shielded plug. The connections are made on pins 2, 3 and 5. The plug can be ordered from the manufacturer or purchased from Kongsberg Maritime. Use part number 387563.

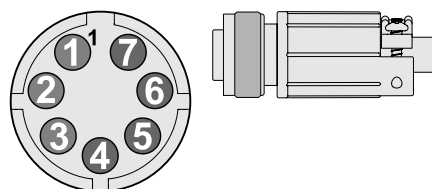

- **Manufacturer:** Switchcraft Conxall
- **Manufacturer's website:** <http://www.conxall.com>
- **True manufacturer's part number:** SF6282-7SG-520

Pin number	1	2	3	4
Signal	Future use	Synchronization Output	Synchronization Input	Future use
Pin number	5	6	7	
Signal	Digital ground	Not used	Not used	

### Minimum cable requirements

- **Conductors:** 4 x 0.5 mm<sup>2</sup>
- **Screen:** Overall braided
- **Voltage:** 60 V
- **Maximum outer diameter:** Defined by the plugs and/or the cable gland

If you need to install a very long cable, increase the cross section.

### Related topics

[Cable drawings and specifications, page 136](#)

[Cable layout and interconnections, page 85](#)

## Single beam low power transducer connection to a circular transducer socket

Maximum four single beam low power transducers can be connected to terminals A through J on the circular 12-pin Amphenol transducer socket (Type 97-12-19S). This socket is used on the General Purpose Transceiver (GPT), and on several versions of the Wide Band Transceiver (WBT).

The other end of the cable is permanently fixed to the transducer.

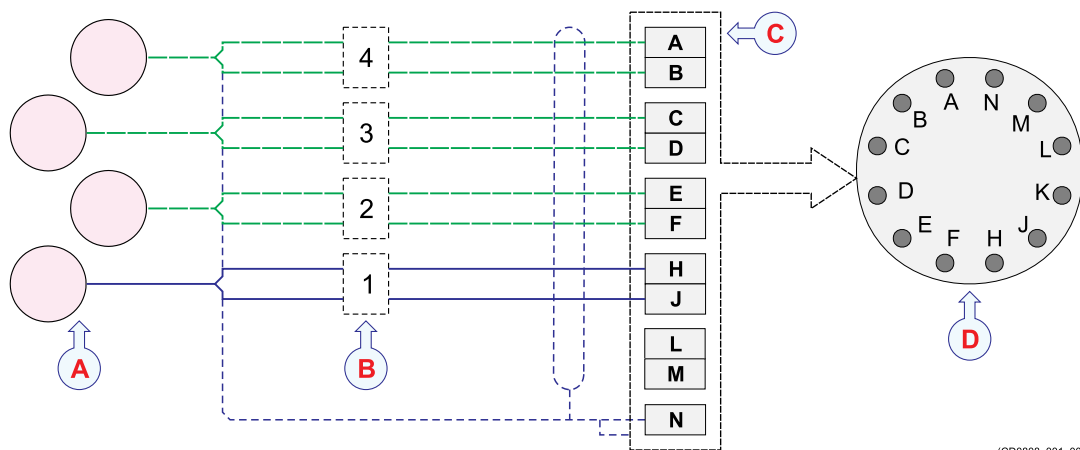

(CD0808\_001\_008)

- A** Transducers
- B** License identification
- C** Connectors on the 12-pin Amphenol socket
- D** Circular 12-pin Amphenol socket (As seen towards the socket (face view))

The cable screen must be connected to the housing on the transducer plug.

### Note

*The black wires in the transducer cable are not for grounding. You must never connect these together. You must never connect any of them to vessel ground.*

If you need to extend the transducer cable, you must splice it correctly. This is very important, as any splice is very vulnerable for noise. Cable can be spliced using two different methods:

- Splicing using a grounded junction box
- Splicing using a junction box that is isolated from vessel's ground

Refer to the dedicated procedures.

We strongly recommend that you install the transducer cable in a steel conduit.

**Cable connections versus software licenses**

When more than one transducer shall be connected to the Wide Band Transceiver (WBT), your software license must support this. If necessary, additional licenses must be purchased. If you have only one license, connect your transducer to sockets H and J on the 12-pin Amphenol socket. For additional licenses, connect as follows:

License 1		License 2		License 3		License 4	
H	J	E	F	C	D	A	B

**Minimum cable requirements**

Not applicable. If you need an extension cable, contact your dealer (or Kongsberg Maritime) for support.

**Related topics**

[Cable drawings and specifications, page 136](#)

[Cable layout and interconnections, page 85](#)

[201575 Transducer connector assembly and wiring, page 318](#)

## Split beam transducer connection to an Amphenol socket

A split beam transducer is connected to terminals A through J on the circular 12-pin Amphenol transducer socket (Type 97-12-19S). This socket is used on the General Purpose Transceiver (GPT), and on several versions of the Wide Band Transceiver (WBT).

The other end of the cable is permanently fixed to the transducer.

The transducer is designed with the individual elements organized in four separate sectors. It is very important that the transducer is correctly installed with the sectors positioned as shown in the illustration (seen from above).

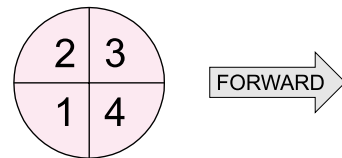

Each sector is connected to a dedicated transceiver channel. In this context, the phrase *transceiver channel* is used to describe one single pathway through the transceiver. This pathway contains one transmitter, one preamplifier and the necessary transmit/receive switching circuitry.

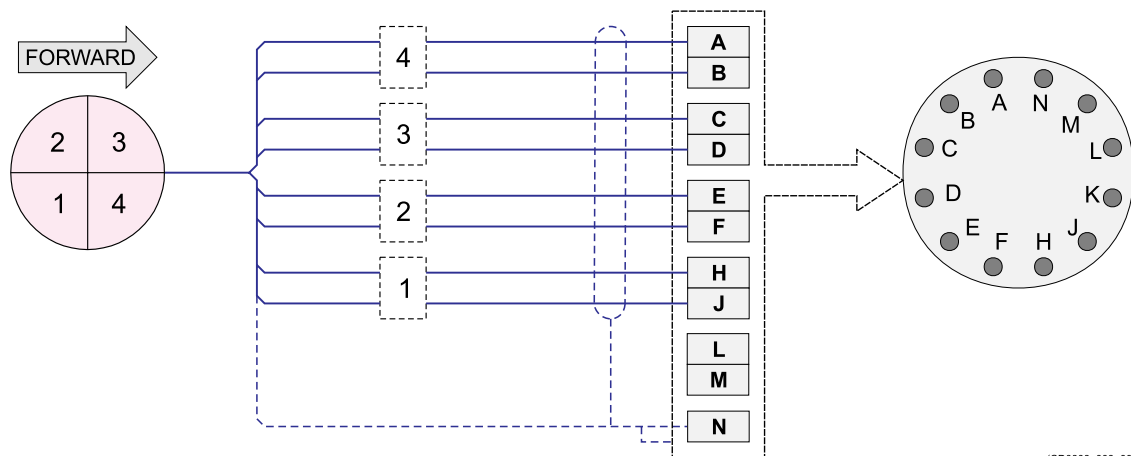

(CD0808\_003\_008)

### Note

*We strongly recommend that you install the transducer cable in a steel conduit.*

Depending on production date, the transducer can be delivered with two different cable types. On older transducers the cable contains black and white conductors. On new transducers the cable contains colour coded conductors.

**Cable with colour coded conductors**

Cable with colour coded conductors			
Sector	Cable colours	Terminal on socket	Transceiver channel
1	White	H	1
	Black	J	
2	Green	E	2
	Black	F	
3	Yellow	C	3
	Black	D	
4	Blue	A	4
	Black	B	
Digital output	Red	L	
Digital ground	Black	M	
Cable screen	Screen	N	

**Cable with only black and white conductors**

The cable has four pairs of white and black conductors. The different sectors are defined by small numbers marked with white text on each black conductor. These are numbered 1 to 4 to identify the transducer sectors. The numbers on the black conductors are the same as four sectors as seen in the illustration and table. The different numbers are quite small and you may need a magnifying glass to see them.

**Note**

*Since the white conductors are not numbered, it is very important to find the pairs that are twisted together.*

Cable with only black and white conductors			
Sector	Cable colours	Terminal on socket	Transceiver channel
1	White	H	1
	Black	J	
2	White	E	2
	Black	F	
3	White	C	3
	Black	D	
4	White	A	4
	Black	B	
Cable screen	Screen	N	

### Connecting to the Amphenol socket

The cable screen must be connected to the housing on the transducer plug.

#### Note

*The black wires in the transducer cable are not for grounding. You must never connect these together. You must never connect any of them to vessel ground.*

---

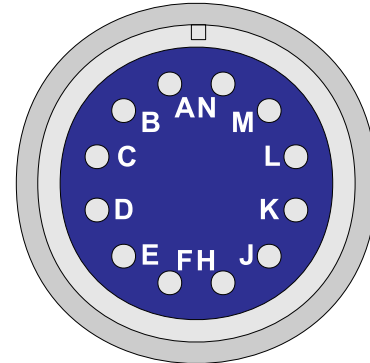

(CD019501\_011\_005)

The software license controls how the transducer is connected to the Wide Band Transceiver (WBT).

The **License Details** text box explains which transceiver channels that are used. Each channel available is listed with the relevant operational frequency and power capacity. For more information, refer to the context-sensitive on-line help.

*Illustration: The connector is seen from the solder side.*

### Splicing the transducer cable

If you need to extend the transducer cable, you must splice it correctly. This is very important, as any splice is very vulnerable for noise. Cable can be spliced using two different methods:

- Splicing using a grounded junction box
- Splicing using a junction box that is isolated from vessel's ground

Refer to the dedicated procedures.

### Minimum cable requirements

Not applicable. If you need an extension cable, contact your dealer (or Kongsberg Maritime) for support.

#### Note

*The software license controls how the transducer is connected to the Wide Band Transceiver (WBT). The **License Details** text box explains which transceiver channels that are used. Each channel available is listed with the relevant operational frequency and power capacity. For more information, refer to the context-sensitive on-line help.*

---

### Related topics

[Cable drawings and specifications, page 136](#)

[Cable layout and interconnections, page 85](#)

[201575 Transducer connector assembly and wiring, page 318](#)



## Split beam transducer connection for single beam use on an Amphenol socket

A split beam transducer can be connected to sockets A and D on a circular 12-pin Amphenol transducer socket (Type 97-12-19S). This allows you to use the transducer as a single beam unit.

The other end of the cable is permanently fixed to the transducer.

The transducer is designed with the individual elements organized in four separate sectors. It is very important that the transducer is correctly installed with the sectors positioned as shown in the illustration (seen from above). Each sector is connected to a dedicated transceiver channel. In this context, the phrase *transceiver channel* is used to describe one single pathway through the transceiver. This pathway contains one transmitter, one preamplifier and the necessary transmit/receive switching circuitry.

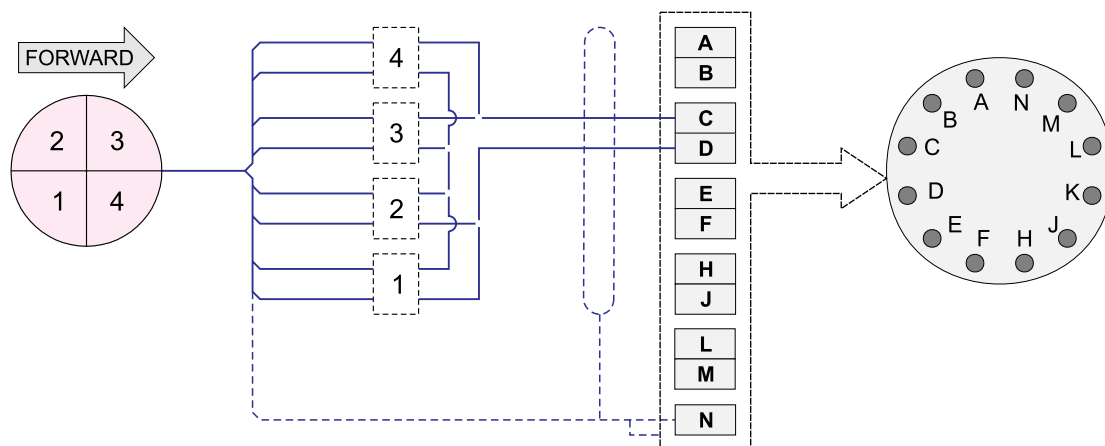
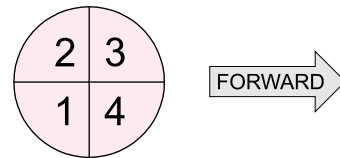

### Note

*We strongly recommend that you install the transducer cable in a steel conduit.*

Depending on production date, the transducer can be delivered with two different cable types. On older transducers the cable contains black and white conductors. On new transducers the cable contains colour coded conductors.

**Cable with colour coded conductors**

Cable with colour coded conductors			
Sector	Cable colours	Terminal on socket	Transceiver channel
1	White	H	1
	Black	J	
2	Green	E	2
	Black	F	
3	Yellow	C	3
	Black	D	
4	Blue	A	4
	Black	B	
Digital output	Red		
Digital ground	Black		
Cable screen	Screen	N	
Do not connect <i>Digital output</i> and <i>Digital ground</i> to the transceiver socket.			

**Cable with only black and white conductors**

The cable has four pairs of white and black conductors. The different sectors are defined by small numbers marked with white text on each black conductor. These are numbered 1 to 4 to identify the transducer sectors. The numbers on the black conductors are the same as four sectors as seen in the illustration and table. The different numbers are quite small and you may need a magnifying glass to see them.

**Note**

*Since the white conductors are not numbered, it is very important to find the pairs that are twisted together.*

Cable with only black and white conductors			
Sector	Cable colours	Terminal on socket	Transceiver channel
1	White	H	1
	Black	J	
2	White	E	2
	Black	F	
3	White	C	3
	Black	D	
4	White	A	4
	Black	B	
Cable screen	Screen	N	

### Connecting to the Amphenol socket

The cable screen must be connected to the housing on the transducer plug.

#### Note

*The black wires in the transducer cable are not for grounding. You must never connect these together. You must never connect any of them to vessel ground.*

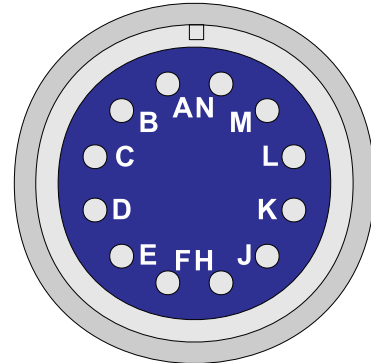

(CD019501\_011\_005)

The software license controls how the transducer is connected to the Wide Band Transceiver (WBT).

The **License Details** text box explains which transceiver channels that are used. Each channel available is listed with the relevant operational frequency and power capacity. For more information, refer to the context-sensitive on-line help.

*Illustration: The connector is seen from the solder side.*

### Splicing the transducer cable

If you need to extend the transducer cable, you must splice it correctly. This is very important, as any splice is very vulnerable for noise. Cable can be spliced using two different methods:

- Splicing using a grounded junction box
- Splicing using a junction box that is isolated from vessel's ground

Refer to the dedicated procedures.

### Minimum cable requirements

Not applicable. If you need an extension cable, contact your dealer (or Kongsberg Maritime) for support.

### Related topics

[Cable drawings and specifications, page 136](#)

[Cable layout and interconnections, page 85](#)

[201575 Transducer connector assembly and wiring, page 318](#)

## Burton underwater connectors on split beam transducers for deep water

A selection of the Simrad transducers have been designed to operate in deep water. These are intended for installation in subsea constructions, with autonomous transceivers, or inside a towed body. Several of the Simrad transducers for deep water operation have been fitted with subsea connectors from Burton.

Deep water transducers are fitted with only a short cable, and this is terminated in a female underwater connector.

When the transducer is installed, the design of the subsea device must include a watertight junction box with the matched male panel socket. The transducer cable must then be fed from the junction box to the vessel or land station, or to a transceiver built into the subsea unit. Without a local transceiver, adequate protection must be provided to support the transducer cable.

### Burton connector

The Burton connector used on the cable is an 8-pin Series 55.

The 5500 Series is an extremely rugged and reliable underwater electrical connector. It is the standard Burton connector series with pins in the receptacles and sockets in the plugs. The pin and socket relationship is due to the fact that in most applications, power runs from the plug into the receptacle. For safety reasons, it is desirable never to have power available on the pin side.

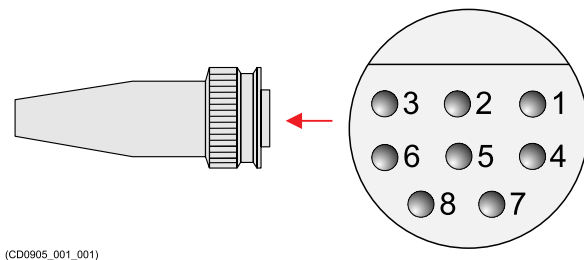

*Burton subsea connectors, #CI-Subsea 102010, 2014*

For more information about the connectors, refer to the manufacturer's website:

<http://www.cooperinterconnect.com>

### Subsea female connector used on the cable

Burton subsea female 8-pin connector (Series 55): **370-076837**

True manufacturer's part number: **5501-2008-0005**

### Suggested panel male connector

Burton male panel 8-pin connector (with flange mount): **370-084169**

True manufacturer's part number: **5506-2008-0004**

**Pin configuration**

Pin on connector	Sectors	Pin on GPT connector	Sector position
1	Sector 1 (+)	H	Aft starboard
4	Sector 1 (-)	J	
2	Sector 2 (+)	E	Aft port
5	Sector 2 (-)	F	
3	Sector 3 (+)	C	Fore port
6	Sector 3 (-)	D	
7	Sector 4 (+)	A	Fore starboard
8	Sector 4 (-)	B	

**Related topics**

[Cable drawings and specifications, page 136](#)

[Cable layout and interconnections, page 85](#)

## About serial lines

A preferred method to establish communication between the EK80 and peripheral devices, is by means of serial lines. Several serial line standards are available, each with different qualities.

Unless otherwise specified, these cables must be provided by the installation shipyard.

### RS-232 serial communication

An RS-232 serial port was once a standard feature of a personal computer, used for connections to modems, printers, mice, data storage, uninterruptible power supplies, and other peripheral devices. However, RS-232 is hampered by low transmission speed, large voltage swing, and large standard connectors. [...] Nevertheless, RS-232 devices are still used, especially in industrial machines, networking equipment and scientific instruments.

*<https://en.wikipedia.org/wiki/RS-232> (September 2015)*

Maximum length for an RS-232 serial cable is typically 60 meters with 2400 bps data rate, however this depends on the cable quality. Always check the cable manufacturers specifications for the actual "shunt capacitance". A common figure is 47.5 pF/m, which gives a maximum cable length of about 50 meters.

#### Note

---

*Most RS-232 cables do not support all the signals in the standard RS-232 specification. Observe that long runs of unshielded cable will pick up noise easily. This is because the RS-232 signals are not balanced.*

---

Even though a standard exist for RS-232 pin configuration, certain manufacturer may still choose their own connector pins for the various signals used. In order to make the RS-232 connection to your peripheral device work properly, you must always consult the relevant instructions provided by the device manufacturer.

For more information about the RS-232 serial communication standard, see (for example):

- <https://en.wikipedia.org/wiki/RS-232>

### RS-422 serial communication

While RS-232 is the most common serial interface for communicating with external devices using the NMEA standard, it only allows for one transmitter and one receiver on each line.

RS-422 provides a mechanism for transmitting data up to 10 Mbits/s. This interface format uses a balanced signal on two wires. This increases both the maximum baud rate and the physical length of the cable, and it reduces the noise. With a high quality cable, you can use RS-422 on distances up to 1500 meters even in noisy environments. RS-422 is also specified for multi-drop applications. This means that one transmitter can send data to up to 10 receivers.

**Note**

---

*There are no common standard for RS-422 pin configuration. Any manufacturer may choose their own connector pins for the various signals used. In order to make the RS-422 connection to your peripheral device work properly, you must always consult the relevant instructions provided by the device manufacturer.*

---

Use a cable with twisted pairs.

For more information about the RS-422 serial communication standard, see (for example):

- <https://en.wikipedia.org/wiki/RS-422>

**RS-485 serial communication**

RS-485 (also known as TIA-485-A) is a standard defining the electrical characteristics of drivers and receivers for use in balanced digital multipoint systems. The standard is published by the Telecommunications Industry Association/Electronic Industries Alliance (TIA/EIA). Digital communications networks implementing the RS-485 standard can be used effectively over long distances and in electrically noisy environments. Multiple receivers may be connected to such a network in a linear, multi-drop configuration.

RS-485 offers data transmission speeds of 35 Mbit/s up to 10 m and 100 kbit/s at 1200 m. Since it uses a differential balanced line over twisted pair (like RS-422), it can span relatively large distances (typically up maximum 1200 m). In contrast to RS-422, which has a single driver circuit which cannot be switched off, RS-485 drivers need to be put in transmit mode explicitly by asserting a signal to the driver. This allows RS-485 to implement linear bus topologies using only two wires. The equipment located along a set of RS-485 wires are interchangeably called nodes, stations or devices.

RS-485, like RS-422, can be made full-duplex by using four wires. Since RS-485 is a multi-point specification, however, this is not necessary in many cases.

**Note**

---

*There are no common standard for RS-485 pin configuration. Any manufacturer may choose their own connector pins for the various signals used. In order to make the RS-485 connection to your peripheral device work properly, you must always consult the relevant instructions provided by the device manufacturer.*

---

Use a cable with twisted pairs.

For more information about the RS-485 serial communication standard, see (for example):

- <https://en.wikipedia.org/wiki/RS-485>

**Related topics**

[Cable drawings and specifications, page 136](#)

[RS-232 serial line connection using five wires, page 141](#)

[RS-422 serial line connection using five wires, page 142](#)

[RS-232 used as synchronization trigger \(input or output\), page 143](#)

[RS-485 serial line connection using two or four wires, page 144](#)

[Moxa CP114EL-I Serial line adapter, page 145](#)

[Cable layout and interconnections, page 85](#)



## Basic cable requirements

It is very important that all systems cables are installed correctly. All cables must be properly supported and protected, and all relevant precautions must be made to prevent unwanted noise.

### Topics

[Cable trays, page 167](#)

[Radio frequency interference, page 168](#)

[Physical protection of cables, page 168](#)

[Grounding of system cables, page 169](#)

[Cable connections and terminations, page 169](#)

[Cable identification, page 170](#)

[Cable glands and termination procedures, page 170](#)

### Cable trays

All permanently installed cables associated with the system must be supported and protected along their entire lengths using conduits and/or cable trays.

The only exception to this rule is over the final short distance (maximum. 0.5 meters) as the cables run into the cabinets/units to which they are connected. These short service loops are to allow the cabinets to move on their shock mounts, and to allow maintenance and repair.

- 1 Wherever possible, cable trays must be straight, accessible and placed so as to avoid possible contamination by condensation and dripping liquids (oil, etc.). They must be installed away from sources of heat, and must be protected against physical damage. Suitable shields must be provided where cables are installed in the vicinity of heat sources.
- 2 Unless it is absolutely unavoidable, cables should not be installed across the vessel's expansion joints. If the situation is unavoidable, a loop of cable having a length proportional to the possible expansion of the joint must be provided. The minimum internal radius of the loop must be at least twelve times the external diameter of the cable.
- 3 Where a service requires duplicate supply lines, the cables must follow separate paths through the vessel whenever possible.
- 4 Signal cables must not be installed in the same cable tray or conduit as high-power cables.
- 5 Cables containing insulation materials with different maximum-rated conductor temperatures should not be bunched together (that is, in a common clip, gland,

conduit or duct). When this is impractical, the cables must be carefully arranged such that the maximum temperature expected in any cable in the group is within the specifications of the lowest-rated cable.

- 6 Cables with protective coverings which may damage other cables should not be grouped with other cables.
- 7 Cables having a copper sheath or braiding must be installed in such a way that galvanic corrosion by contact with other metals is prevented.
- 8 To allow for future expansion of the system, all cables should be allocated spare conductor pairs. Also, space within the vessel should be set aside for the installation of extra cables.

### **Related topics**

[Basic cable requirements, page 167](#)

[Cable layout and interconnections, page 85](#)

## **Radio frequency interference**

All cables that are to be permanently installed within 9 m (30 ft) of any source of Radio Frequency (RF) interference such as a transmitter aerial system or radio transmitters, must, unless shielded by a metal deck or bulkhead, be adequately screened

Suitable screening can be established using sheathing, braiding or other suitable material. In such a situation flexible cables should be screened wherever possible.

It is important that cables, other than those supplying services to the equipment installed in a radio room, are not installed through a radio room, high power switch gear or other potential sources of interference. Cables which must pass through a radio room must be screened by a continuous metal conduit which must be bonded to the screening of the radio room at its points of entry and exit.

### **Related topics**

[Basic cable requirements, page 167](#)

[Cable layout and interconnections, page 85](#)

## **Physical protection of cables**

Cables exposed to the risk of physical damage must be enclosed in a steel conduit or protected by a metal casing unless the cable's covering (for example armour or sheath) is sufficient to protect it from the damage risk.

Cables exposed to an exceptional risk of mechanical damage (for example in holds, storage-spaces and cargo-spaces) must be protected by a suitable casing or conduit, even when armoured, if the cable covering does not guarantee sufficient protection for the cables.

Metallic materials used for the physical protection of cables must be suitably protected against corrosion.

**Related topics**

[Basic cable requirements, page 167](#)

[Cable layout and interconnections, page 85](#)

## Grounding of system cables

All metallic cable coverings (armour, metallic sheathing and other protection) must be electrically connected to the vessel's hull at both ends except in the case of final sub-circuits where they should be connected at the supply end only.

Grounding connections should be made using a conductor which has a cross-sectional area appropriate for the current rating of the cable, or with a metal clamp which grips the metallic covering of the cable and is bonded to the hull of the vessel. These cable coverings may also be grounded by means of glands specially intended for this purpose and designed to ensure a good ground connection. The glands used must be firmly attached to, and in good electrical contact with, a metal structure grounded in accordance with these recommendations.

Electrical continuity must be ensured along the entire length of all cable coverings, particularly at joints and splices. In no case should the shielding of cables be used as the only means of grounding cables or units.

Metallic casings, pipes and conduits must be grounded, and when fitted with joints these must be mechanically and electrically grounded locally.

**Related topics**

[Basic cable requirements, page 167](#)

[Cable layout and interconnections, page 85](#)

## Cable connections and terminations

All cable connections are shown on the applicable cable plan and/or interconnection diagrams.

Where the cable plan shows cable connections outside an equipment box outline, the connections are to be made to a plug or socket which matches the plug or socket on that particular item of equipment.

Where two cables are connected in series via a junction box or terminal block, the screens of both cables must be connected together, but not grounded.

Care must be taken to ensure that the correct terminations are used for all cable conductors, especially those that are to be connected to terminal blocks. In this case, crimped sleeve-terminations must be fitted to prevent the conductor core from fraying and making a bad connection with the terminal block. It is also of the utmost importance

that where crimped terminations are used, the correct size of crimp and crimping tool are used. In addition, each cable conductor must have a minimum of 15 cm slack (service loop) left before its termination is fitted.

**Related topics**

[Basic cable requirements, page 167](#)

[Cable layout and interconnections, page 85](#)

## Cable identification

Cable identification codes corresponding to the cable number shown in the cable plan must be attached to each of the external cables.

The identification codes should be positioned on the cable in such a way that they are readily visible after all panels have been fitted.

In addition, each cable conductor should be marked with the terminal board number or socket to which it is connected.

**Related topics**

[Basic cable requirements, page 167](#)

[Cable layout and interconnections, page 85](#)

## Cable glands and termination procedures

Cable glands are used to attach and secure the end of a cable to the equipment. Cable glands may also be used for sealing cables passing through bulkheads or gland plates.

**Related topics**

[Basic cable requirements, page 167](#)

[Cable layout and interconnections, page 85](#)

## About cable glands

Cable glands are used whenever a cable passes through a watertight bulkhead or into a cabinet, to seal the opening through which the cable passes and to protect the cable from abrasion on the edges of the hole.

There are many different types of cable gland on the market. The cable glands are not supplied with the system.

**Note**

---

*Even though the cabinets from Kongsberg Maritime may be prepared for specific types of cable glands, the installation shipyard will be responsible for selecting cable gland types and installing them.*

---

A cable gland (in the U.S. more often known as a cable connector or fitting) is a device designed to attach and secure the end of a cable to the equipment. A cable gland provides strain-relief and connects by a means suitable for the type and description of cable for which it is designed—including provision for making electrical connection to the armour or braid and lead or aluminium sheath of the cable, if any. Cable glands may also be used for sealing cables passing through bulkheads or gland plates.

Cable glands are mechanical cable entry devices and can be constructed from metallic or non-metallic materials. They are used throughout a number of industries in conjunction with cable and wiring used in electrical instrumentation and automation systems.

Cable glands may be used on all types of electrical power, control, instrumentation, data and telecommunications cables. They are used as a sealing and termination device to ensure that the characteristics of the enclosure which the cable enters can be maintained adequately.

*[http://en.wikipedia.org/wiki/Cable\\_gland](http://en.wikipedia.org/wiki/Cable_gland) (February 2014)*

### **Related topics**

[Basic cable requirements, page 167](#)

[Cable glands and termination procedures, page 170](#)

[Cable layout and interconnections, page 85](#)

### **Preparing cables for termination**

Whenever a cable shall penetrate a cabinet or a bulkhead using a cable gland, the termination of the cable must be prepared.

### **Prerequisites**

Electrical installations can only be done by certified electricians. All necessary tools and instruments required must be available. The installation shipyard must prepare detailed drawings of the electrical system, and identify each cable.

### **Context**

Cable glands are used whenever a cable passes through a watertight bulkhead or into a cabinet, to seal the opening through which the cable passes and to protect the cable from abrasion on the edges of the hole. The cable glands are not supplied with the EK80.

### **Note**

---

*There are many different types of cable gland on the market. This procedure describes the types used (now and previously) as standard in the units manufactured by Kongsberg Maritime. Even though the cabinets from Kongsberg Maritime may be prepared for specific types, the installation shipyard will be responsible for selecting cable gland types and installing them.*

---

## Procedure

- 1 Ensure all the cables to be connected are completely isolated from any power sources.

For safety reasons, switch off and remove the power supply fuses from any units or systems into which the cables are already connected.

- 2 Select the cable to be connected into the cabinet, and select the cable gland through which the cable is to pass.

### Note

---

*A minimum of 5 cm (recommended 5 to 10 cm) of cable slack must be allowed, both inside and outside the unity or cabinet, when you install cables. This is to allow for vibration damping, maintenance and measurement errors. Always double-check your measurements before taking any irreversible actions.*

---

- 3 Measure the maximum length of cable.
  - a If the cable has already been installed in conduits: Measure the maximum length of cable required to reach from the final cable clip outside the cabinet to the terminal block(s) inside the cabinet. Add 20 cm, and remove the excess cable.
  - b If the cable has not been installed in conduits: Measure the maximum length of wire required to reach from the cable gland to the terminal block(s) inside the cabinet. Add 20 cm, and mark the cable.

### Note

---

*The outer insulation on the cable will extend into the cable gland to a point approximately 5 mm outside the outer surface of the cabinet wall.*

---

- 4 Carefully remove the outer insulation from the required cable length.  
Be careful! Do not damage the screen!
- 5 Leaving an appropriate length of the screen exposed from the insulation, cut off the remainder.

## Related topics

[Basic cable requirements, page 167](#)

[Cable glands and termination procedures, page 170](#)

[Cable layout and interconnections, page 85](#)

## **Securing and terminating cables**

Once a cable has been prepared for termination, it must be connected to a unit or cabinet.

### **Prerequisites**

Electrical installations can only be done by certified electricians. All necessary tools and instruments required must be available. The installation shipyard must prepare detailed drawings of the electrical system, and identify each cable.

### **Context**

Observe the relevant cable plans, cable lists and/or interconnection drawings for the EK80.

### **Procedure**

- 1 Referring to the wiring diagram and ensuring that there is 5 to 10 cm slack cable inside the cabinet, prepare and connect the cable cores to the appropriate terminals and/or plugs within or onto the cabinet.
- 2 Secure the cable using cable clips.
- 3 Check the terminal connections against the wiring diagram to ensure they are correct. Follow the same procedure for all the cables and cable glands.
- 4 Check the cabinet to ensure all tools and rubbish are removed, then close the cabinet door.
- 5 Take the appropriate safety measures, then replace the fuses and apply power to the system.
- 6 Perform a relevant system test to ensure the installation has been made successfully.

### **Related topics**

[Basic cable requirements, page 167](#)

[Cable glands and termination procedures, page 170](#)

[Cable layout and interconnections, page 85](#)

## Using multi-diameter cable sealing

Cable sealing systems are available from several manufacturers, and multi-diameter types are becoming increasingly popular due to their ease of use.

### Prerequisites

Electrical installations can only be done by certified electricians. All necessary tools and instruments required must be available. The installation shipyard must prepare detailed drawings of the electrical system, and identify each cable.

*Illustration:*

*Sealing system example; the finished assembly*



### Context

Only a brief description of the sealing system will be presented here. Further information with relevant technical specifications and installation descriptions must be obtained from the manufacturer.



*Roxtec modules (Image from Roxtec website)*

The illustrations and examples here are provided by the following manufacturer:

Roxtec International AB  
Box 540  
S-371 23 Karlskrona, SWEDEN

- <http://www.roxtec.com>



*Illustration:*

*Roxtec steps (Image from Roxtec website)*

The Roxtec system is available with a large number of various modules and compression units. The system complies with current screening and EMC requirements.

**Procedure**

- 1 Cut an opening in the structure (bulkhead, cabinet etc) you wish to penetrate.

The hole must be large enough to fit one of the standard rectangular or circular frames provided by the sealing system manufacturer.

**Note**

*The chosen solution must comply with the fire and/or pressure demands for the vessel. If the sealing is to be used under water, both pressure and material requirements must be taken into consideration.*

- 2 Mount the frame.
- 3 Pull the cable(s) through the frame.  
In most cases the opening will be large enough to accept the plugs on the cables.
- 4 Secure each cable with a square sealing module.
- 5 Adjust the module to fit the cable's outer diameter.
- 6 When the required number of modules are installed, tighten the assembly with a compression unit.

**Further requirements**

For a complete installation procedure, refer to the relevant documentation provided by the manufacturer.

**Related topics**

- [Basic cable requirements, page 167](#)
- [Cable glands and termination procedures, page 170](#)
- [Cable layout and interconnections, page 85](#)

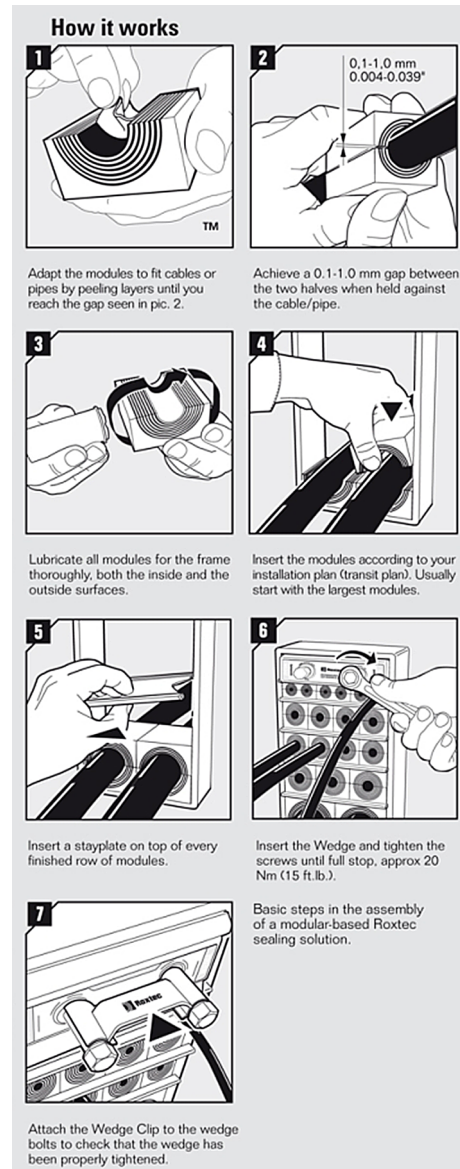

# Dimensional surveying

The Simrad EK80 Wide band scientific echo sounder is a precision instrument. In order to provide data that are both detailed and correct you must align, position and calibrate the sensors and each transducer on your vessel.

## Topics

[Quality assurance of EK80 data, page 177](#)

[Surveying the transducer and the navigation sensors, page 179](#)

[Dimensional survey accuracy requirements for ADCP operations, page 181](#)

[Dimensional survey accuracy requirements for echo sounding operations, page 182](#)

[Vessel coordinate system, page 182](#)

## Quality assurance of EK80 data

The Simrad EK80 Wide band scientific echo sounder is a precision instrument for scientific measurements.

The EK80 has been designed for target strength measurements of objects in the water column. In order to obtain precision data that are both detailed and correct, it is necessary to align the transducer, measure the location and offset of each sensor in relation to the vessel's coordinate system, and calibrate the complete EK80 prior to use.

### Note

---

*Modest accuracy requirements apply when your EK80 system is only used to investigate objects in the water column. When used for acoustic Doppler current profiler (ADCP) measurements the accuracy requirements are increased.*

---

The quality assurance tasks required for EK80 include:

- Aligning the transducer during installation
- Dimensional surveying
- Calibration

The alignment and dimensional surveying must be done during the EK80 installation with the vessel in dry dock. The first calibration is normally done at sea during the Sea Acceptance Test. We strongly recommend that calibration is repeated before and after each survey. This is important for achieving high-quality measurement results.

### Alignment

The alignment tasks required for EK80 include:

- Measure and adjust the transducer to ensure that it has been mounted horizontally within the given tolerances.
- Measure and adjust the transducer to ensure correct orientation.

### Note

---

*Modest accuracy requirements apply when your EK80 system is only used to investigate objects in the water column. If this is the case the alignment of the transducer can be omitted.*

*When used for acoustic Doppler current profiler (ADCP) measurements the accuracy requirements are increased. Aligning the transducer for correct installation within the given tolerances requires professional skills. The installation engineers from Kongsberg Maritime are neither equipped nor trained to align a transducer, and they have no means of verifying the results until calibration at sea has been done.*

---

### Dimensional surveying

The dimensional surveying tasks recommended for EK80 include:

- Define the vessel coordinate system.

The vessel coordinate system is established to define the relative physical locations of systems and sensors. When you have several different sensors and transducers on your vessel, and you wish each of them to provide accurate data, you need to know their relative physical positions.

- Define the location of the *origin* in the coordinate system.

The *origin* is the common reference point where all three axis in the vessel coordinate system meet. All physical locations of the vessel's sensors (radar and positioning system antennas, echo sounder and sonar transducers, motion reference units, etc.) are referenced to the origin.

- Define the vessel's centre line.
- Measure the physical location of each sensor (or sensor antenna). Place it in the coordinate system.

By means of the vessel coordinate system, the physical location of every sensor can be defined using three numerical values for X, Y and Z. These values must define the vertical and horizontal distances from a single reference point; the origin. The accuracy of the three numerical values for X, Y and Z defines the accuracy of the sensor data.

- Measure the physical location and orientation of the transducer. Place it in the coordinate system.

#### Note

---

*Determining the relative positions and orientations of the sensors and the transducer with high accuracy is important. This requires professional surveying done by qualified and trained personnel using proven equipment and methods for maritime dimensional surveying. We recommend that you use third-party consultants with well proven experience with vessel dimensional control. Sufficient time and satisfactory work conditions must be given to the survey work. The installation engineers from Kongsberg Maritime are neither equipped nor trained to do dimensional surveying.*

---

The information provided by the dimensional survey is entered into the EK80 software as installation parameters.

#### **Calibration**

During the sea trials, calibration surveys are required as described in the EK80 end user documentation.

In order to check and verify the performance of the EK80 system, we strongly recommend that calibration surveys are done at regular intervals, or prior to any large survey. If an existing sensors have been replaced, or a new sensor has been added to the vessel, a new calibration is required. A new calibration may also be required after an update of the EK80 software. Refer to the software release note.

The information provided by the calibration is entered into the EK80 software as operational parameters. This is done automatically.

**Note**

---

*Calibration must be taken seriously. The final verification of correct installation can only be done during calibration at sea. Installation and operational parameters that do not meet the accuracy requirements may lead to a malfunctioning EK80 system. To achieve the best results, the calibration must be planned and done carefully. If the accuracy requirements are not met, and this is found to be the reason for a malfunctioning system, the vessel will most likely need to be dry docked in order to repeat the dimensional survey.*

---

**Related topics**

[Dimensional surveying, page 176](#)

## Surveying the transducer and the navigation sensors

An overall procedure specifying the main tasks is provided. The detailed knowledge about how to do the measurements is offered by the consultants doing the work.

**Prerequisites**

Determining the relative positions and orientations of the sensors and the transducer with high accuracy is important. This requires professional surveying done by qualified and trained personnel using proven equipment and methods for maritime dimensional surveying. We recommend that you use third-party consultants with well proven experience with vessel dimensional control. Sufficient time and satisfactory work conditions must be given to the survey work. The installation engineers from Kongsberg Maritime are neither equipped nor trained to do dimensional surveying.

We strongly recommend that you make the dimensional survey measurements when the vessel is in dry dock.

**Context**

All measurements must be made after the installation of the transducer and the navigation sensors. The following measurements must be made for each sensor:

- Physical position with reference to the vessel coordinate system (X, Y and Z) and the chosen origin.
- Angular values (pitch and roll)
- Heading with reference to the centre line

## Note

---

*Modest accuracy requirements apply when your EK80 system is only used to investigate objects in the water column. When used for acoustic Doppler current profiler (ADCP) measurements the accuracy requirements are increased.*

*For all measurements, observe the relevant accuracy requirements.*

---

## Procedure

- 1 Define the vessel coordinate system.
- 2 Define the location of the *origin* in the coordinate system. If required, identify the location with a physical marking.
- 3 Set out the required coordinate reference points throughout the vessel.
- 4 Define the vessel's centre line. If required, identify the line with physical markings.
- 5 Measure the physical location and orientation of the transducer.
- 6 Measure the physical location and rotation angles of the motion reference unit (MRU).
- 7 Measure the physical location and rotation angles of the heading sensor.
- 8 Measure the physical location and rotation angles of the global positioning system (GPS) antenna.
- 9 Measure the physical location and rotation angles of other relevant sensors (or sensor antennas).

## Result

All results from the dimensional survey measurements must be summarized in a report by the consultants doing the work.

## Further requirements

In order to check and verify the performance of the EK80 system, we strongly recommend that calibration surveys are done at regular intervals, or prior to any large survey. If an existing sensors have been replaced, or a new sensor has been added to the vessel, a new calibration is required. A new calibration may also be required after an update of the EK80 software. Refer to the software release note.

## Related topics

[Dimensional surveying, page 176](#)

## Dimensional survey accuracy requirements for ADCP operations

Minimum accuracy requirements are defined for the dimensional survey. Higher accuracy will provide better survey results.

Modest accuracy requirements apply when your EK80 system is only used to investigate objects in the water column. When used for acoustic Doppler current profiler (ADCP) measurements the accuracy requirements are increased. The accuracy requirements provided have been determined from considerations on how they contribute to the total EK80 accuracy. Any errors in these measurements should not contribute significantly to depth or position errors in the soundings.

### Note

---

*The given accuracies are maximum values. If easily achievable, better accuracies should be obtained.*

---

### Transducer

- **Position (x,y):**  $\pm 0.05$  m
- **Position (z):**  $\pm 0.02$  m
- **Pitch:**  $\pm 0.10^\circ$
- **Roll:**  $\pm 0.025^\circ$
- **Heading:**  $\pm 0.1^\circ$

### Motion Reference Unit (MRU)

- **Position (x,y):**  $\pm 0.05$  m
- **Position (z):**  $\pm 0.05$  m
- **Pitch:**  $\pm 0.05^\circ$
- **Roll:**  $\pm 0.02^\circ$
- **Heading:**  $\pm 0.05^\circ$

### Heading sensor

- **Heading:**  $\pm 0.1^\circ$

### Global positioning system (GPS) (Antenna)

- **Horizontal position (x,y):**  $\pm 0.05$  m
- **Vertical position (z):**  $\pm 0.005$  m

### Waterline reference mark

- **Position (z):**  $\pm 0.005$  m

**Related topics**

[Dimensional surveying, page 176](#)

## Dimensional survey accuracy requirements for echo sounding operations

No specific requirements have been defined for the dimensional survey.

**Related topics**

[Dimensional surveying, page 176](#)

## Vessel coordinate system

The vessel coordinate system is established to define the relative physical locations of systems and sensors.

When you have several different sensors and transducers on your vessel, and you wish each of them to provide accurate data, you need to know their relative physical positions. The antenna of a position sensor is typically mounted high above the superstructure, while a motion sensor is located close to the vessel's centre of gravity. Both of these are physically positioned far away from the transducer on a depth sensor, which may be located closer to the bow. Very often, the information from one sensor depends on data from another. It is then important that the relevant measurements are compensated for these relative distances.

*Example*

If you wish to measure the actual water depth, you will need to know the vertical distance from the echo sounder transducer to the water line. Since the vessel's displacement changes with the amount of cargo, fuel etc, the physical location of the water line on the hull must either be measured at a regular basis, or measured with a second sensor.



In order to establish a system to measure the relative distance between sensors, a virtual coordinate system is established. This coordinate system uses three vectors; X, Y and Z.

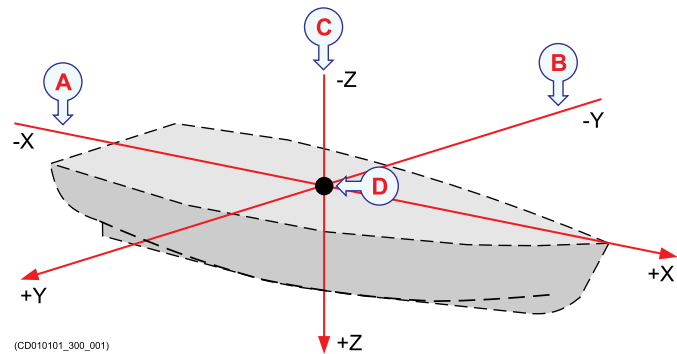

- A** *The X-axis is the longitudinal direction of the vessel, and in parallel with the deck. A positive value for X means that a sensor or a reference point is located ahead of the reference point (origin).*
- B** *The Y-axis is the transverse direction of the vessel, and in parallel with the deck. A positive value for Y means that a sensor or a reference point is located on the starboard side of the reference point (origin).*
- C** *The Z-axis is vertical, and in parallel with the mast. A positive value for Z means that a sensor or a new reference point is located under the reference point (origin).*
- D** *Reference point (Ship Origin)*

### Coordinate system origin

The *origin* is the common reference point where all three axis in the vessel coordinate system meet. All physical locations of the vessel's sensors (radar and positioning system antennas, echo sounder and sonar transducers, motion reference units, etc.) are referenced to the origin. In most cases, the location of the vessel's "official" origin has been defined by the designer or shipyard. This origin is normally identified with a physical marking, and also shown on the vessel drawings.

Frequently used locations are:

- Aft immediately over the rudder (frame 0)
- Vessel's centre of gravity
- The physical location of the motion reference unit (MRU)

### Coordinate system alternative origins

If necessary, other origin locations may be defined for specific products or purposes. One example is the *Navigation Reference Point* that is frequently used. Whenever a vessel is surveyed to establish accurate offset information, the surveyor may also establish an alternative origin location. Whenever relevant, any such alternative locations must be defined using offset values to the "official" origin established by the designer or shipyard. A commonly used alternative origin is the physical location of the vessel's motion reference unit (MRU).

## Defining the physical location of each sensor

By means of the vessel coordinate system, the physical location of every sensor can be defined using three numerical values for X, Y and Z. These values must define the vertical and horizontal distances from a single reference point; the origin. The physical location of the motion reference unit (MRU) is often the most important sensor to define. For many systems, the vessel heading is also a critical measurement.

*Illustration:*

*In this example, a second reference point has been established. It is defined with three positive offset values for X, Y and Z. All values are positive because the new reference point is in front of and below the origin, and on the starboard side.*

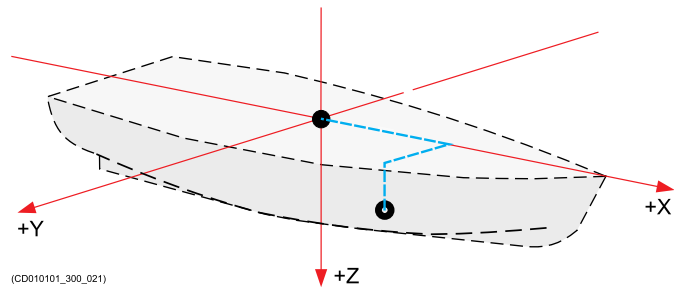

The accuracy of the three numerical values for X, Y and Z defines the accuracy of the sensor data. If you require a high accuracy, for example for underwater positioning, underwater mapping or scientific measurements, you must have each sensor positioned using professional land surveying. For such use, a good alignment survey is critical for high quality results. Surveys are normally done by qualified and trained surveyors using proven survey equipment and methods.

## Related topics

[Preparations, page 43](#)

[Dimensional surveying, page 176](#)

# Setting to work

## Topics

[Setting to work summary, page 186](#)

[Making sure that the EK80 is ready for operational use, page 188](#)

[Turning on the EK80 for the first time, page 199](#)

[Installing and troubleshooting Network Time Protocol \(NTP\), page 214](#)

[Configuring the EK80 for normal operation, page 224](#)

[Interfacing peripheral equipment, page 228](#)

[Test procedures, page 256](#)

[Turning off the EK80, page 276](#)

[Installation remarks, page 278](#)

## Setting to work summary

Once all the hardware units have been installed, and all the cables have been connected, the EK80 can be turned on for the first time, and set to work.

### Prerequisites

Before you can set the EK80 to work, the following work must be finalized.

- All EK80 hardware units have been installed according to the relevant instructions.
- All system cables have been installed.
- All connections have been made.
- All operating power is available.
- All peripheral devices that shall communicate with the EK80 are available and operational.
- All relevant personnel and tools are available.

### Context

This information describes several sequential tasks. Start with the first procedure, proceed with the next until all tasks have been done. Make sure that you only do the specific tasks described, and in the given order. Many tasks here are explained in more detail in separate procedures.

### Note

---

*The installation shipyard must provide all necessary design and installation drawings, as well as the relevant work standards and mounting procedures.*

---

### Procedure

- 1 Do a thorough visual inspection to verify that the EK80 is ready for operational use.
  - a Verify that all hardware have been installed correctly.
  - b Verify that all cables have been connected correctly.
    - [Making sure that the EK80 is ready for operational use, page 188](#)
- 2 Turn on the EK80 for the first time.
  - a Install the EK80 software and the relevant software licenses.
  - b Define the IP address on the Processor Unit Ethernet adapter.
  - c Optional: Install the NTP (Network Time Protocol).

These tasks are only applicable for a EK80 system fitted with relevant hardware for acoustic Doppler current profiler (ADCP) functionality.
  - d On the **Transducer** page, install each transducer.

- e On the **Transceiver Installation** page, connect the transducer(s) to the transceiver(s).
  - [Turning on the EK80 for the first time, page 199](#)
  - [Installing and troubleshooting Network Time Protocol \(NTP\), page 214](#)
  - [Configuring the EK80 for normal operation, page 224](#)
- 3 Set up the interfaces with the external devices (navigation sensors and other peripherals).

To provide correct information, the EK80 needs to communicate with external devices. All these interfaces must be set up in the EK80 user interface.

  - [Interfacing peripheral equipment, page 228](#)
- 4 Make sure that the EK80 is fully operational.

To make sure that the EK80 fulfils all operational and functional requirements, specific tests are provided.

  - [Test procedures, page 256](#)
- 5 Fill in and sign the *Installation Remarks* form, and return it to Simrad.

## Making sure that the EK80 is ready for operational use

### Topics

[Making sure that the AC mains supply voltage is correct, page 188](#)

[Making sure that all EK80 cables are properly connected, page 189](#)

[Visual inspection of the display, page 190](#)

[Visual inspection of the Processor Unit, page 192](#)

[Visual inspection of the Wide Band Transceiver \(WBT\), page 193](#)

[Visual inspection of the WBT Cabinet, page 195](#)

[Visual inspection of the EC150-3C Power Supply Unit, page 197](#)

### Making sure that the AC mains supply voltage is correct

The EK80 operates on AC power from the vessel's mains supply. Before you apply AC power to any EK80 unit, you must verify that the voltage is correct.

#### Prerequisites

The EK80 hardware units are installed as specified in this manual. The EK80 is turned off. You need the following equipment:

- Multimeter

#### Procedure

For each EK80 unit that operates on AC mains:

- 1 Make sure that the unit is connected to AC mains.
- 2 Make sure that the relevant EK80 unit can operate on the power provided.
- 3 If necessary, measure the voltage in the mains outlet.
- 4 Make sure that the circuit breaker on the power circuit can handle the load when the EK80 is turned on.

#### Result

Requirements	Results
Each EK80 unit can operate on the AC mains voltage available.	
Date and signature:	

**Related topics**

[Making sure that the EK80 is ready for operational use, page 188](#)

**Making sure that all EK80 cables are properly connected**

The EK80 relies on communication between each system unit, and between the EK80 and external devices. It is very important that all cables are correctly installed, that the proper cable types have been used, and that all cables are connected correctly.

**Prerequisites**

The EK80 hardware units are installed as specified in this manual.

- The EK80 is turned off.
- All system cables are installed.
- All cable connections are made.

You need the following equipment:

- Cable tester
- Multimeter

**Context**

All cabling is described in the *Cable layout and interconnections* chapter. Refer to the cable plan, the cable list and the basic cable requirements.

**Procedure**

- 1 For each cable in use on the EK80:
  - a Make sure that the cable is installed as specified in the *Cable layout and interconnections* chapter.  
Pay special attention to signal cables. These must not be installed too close to power cables.
  - b Make sure that the terminations at each end of the cable are correct.
  - c Make sure that the cable is properly identified.
- 2 If possible, use a multimeter or a dedicated cable tester to check the continuity in each cable.
- 3 Use a qualification tester to make sure that each Ethernet cable is correctly wired, and meets the specifications related to quality and bandwidth.
- 4 If irregularities are found, write these down in the in the *Installation remarks* table.

## Result

Requirements	Results
All cables are properly connected.	
All cables are properly identified with labels or other types of markings.	
Each Ethernet cable in use is correctly wired.	
Each Ethernet cable in use meets the quality requirements.	
Date and signature:	

## Related topics

[Making sure that the EK80 is ready for operational use, page 188](#)

## Visual inspection of the display

A visual inspection of the EK80 display is required to verify that the unit has not been physically damaged during the installation.

## Prerequisites

The EK80 hardware units are installed as specified in this manual. The EK80 is turned off. You need the following equipment:

- Multimeter

## Context

This test procedure is only applicable when the display is provided by Kongsberg Maritime as a part of the EK80 delivery.

## Procedure

- 1 Make sure that the display is installed in the correct location, and that it is suitably orientated with respect to ambient light conditions and reflections.
- 2 Make sure that the physical installation of the unit has been completed.
  - a Make sure that the structure to which the display is fastened is substantial enough to hold the unit securely under all operating conditions.
  - b If applicable, make sure that the display (or the display mounting bracket) is bolted or welded securely to the deck and/or bulkhead.
  - c If applicable: Make sure that ample ventilation is provided to avoid overheating.
  - d Make sure that ample space is provided around the unit to allow for maintenance and replacement of parts.
  - e Make sure that the bolts, screws or studs that have been used are all of the correct size.



- f Make sure that the correct flat and shake-proof washers have been used.
  - g Make sure that all the nuts have been tightened properly.
  - h Make sure that all welds and brackets have been painted with the correct preservation medium to prevent corrosion.
- 3 Make sure that the unit is not physically damaged, and that the surfaces and paint-work are clean without dents or scratches.
- The physical handling during the installation may have caused some minor scratches to the surfaces or paint-work. This can be accepted. However, if rough handling has caused serious damage, this must be recorded with a written statement and necessary photos, so that corrective actions can be made.
- 4 Make sure that the unit is firmly connected to ship's ground.
- a The unit must be connected to the ship's ground with an earthing strap. The strap must be in addition to any incidental electrical contact made by the mounting lugs on the unit.
  - b Use a standard multimeter to check that the resistance between the unit and the ship's ground is approximately 0 (zero)  $\Omega$ .
- 5 Make sure that cable installation has been completed.
- a Make sure that all cables leading to and from the unit have been properly mounted and secured.
  - b Make sure that enough slack has been provided on each cable to allow for maintenance and replacement.
- 6 Make sure that the unit has been identified with the relevant product label(s), and that one label includes the part and serial numbers.

## Result

Requirements	Results
The display is correctly installed with easy access for maintenance and replacement of parts.	
The display is free from scratches, dents or other physical damage.	
Free access to all the connectors on the display is provided. All cables are properly mounted with enough slack.	
The display is properly grounded.	
Date and signature:	

## Related topics

[Making sure that the EK80 is ready for operational use, page 188](#)

## Visual inspection of the Processor Unit

A visual inspection of the EK80 Processor Unit is required to verify that the unit has not been physically damaged during the installation.

### Prerequisites

The EK80 hardware units are installed as specified in this manual. The EK80 is turned off. You need the following equipment:

- Multimeter

### Context

This test procedure is only applicable when the Processor Unit is provided by Kongsberg Maritime as a part of the EK80 delivery.

### Procedure

- 1 Make sure that the computer is installed in the correct location, and that it is suitably oriented for replacement and cabling.
- 2 Make sure that the physical installation of the unit has been completed.
  - a Make sure that you have free access to rear and front side connectors on the computer for maintenance purposes.
  - b Make sure that ample space is provided to open/close DVD and/or CD lids (if relevant), and to insert and remove USB flash drives.
  - c If applicable: Make sure that ample ventilation is provided to avoid overheating.
  - d Make sure that ample space is provided around the unit to allow for maintenance and replacement of parts.
  - e Make sure that the bolts, screws or studs that have been used are all of the correct size.
  - f Make sure that the correct flat and shake-proof washers have been used.
  - g Make sure that all the nuts have been tightened properly.
  - h Make sure that all welds and brackets have been painted with the correct preservation medium to prevent corrosion.
- 3 Make sure that the unit is not physically damaged, and that the surfaces and paint-work are clean without dents or scratches.

The physical handling during the installation may have caused some minor scratches to the surfaces or paint-work. This can be accepted. However, if rough handling has caused serious damage, this must be recorded with a written statement and necessary photos, so that corrective actions can be made.

- 4 Make sure that the unit is firmly connected to ship's ground.

- a Make sure that the unit is securely connected to the ship's ground with an earthing strap. The strap must be in addition to any incidental electrical contact made by the mounting lugs on the unit.
  - b Use a standard multimeter to check that the resistance between the unit and the ship's ground is approximately 0 (zero)  $\Omega$ .
- 5 Make sure that cable installation has been completed.
- a Make sure that all cables leading to and from the unit have been properly mounted and secured.
  - b Make sure that enough slack has been provided on each cable to allow for maintenance and replacement.
- 6 Make sure that the unit has been identified with the relevant product label(s), and that one label includes the part and serial numbers.

## Result

Requirements	Results
The Processor Unit is correctly installed with easy access for maintenance and replacement of parts.	
The Processor Unit is free from scratches, dents or other physical damage.	
Free access to all the connectors on the Processor Unit is provided. All cables are properly mounted with enough slack.	
The Processor Unit can be fully opened for access to the internal parts.	
The Processor Unit is properly earthed.	
Date and signature:	

## Related topics

[Making sure that the EK80 is ready for operational use, page 188](#)

## Visual inspection of the Wide Band Transceiver (WBT)

A visual inspection of the Wide Band Transceiver (WBT) is required to verify that the unit has not been physically damaged during the installation. If more than one Wide Band Transceiver (WBT) is used, each must be inspected separately.

## Prerequisites

The EK80 hardware units are installed as specified in this manual. The EK80 is turned off. You need the following equipment:

- Multimeter

## Context

The steps in this procedure must be repeated for each Wide Band Transceiver (WBT) that is installed.

## Procedure

- 1 Make sure that the Wide Band Transceiver (WBT) is installed in the correct location, and that it is suitably oriented for easy maintenance and replacement of parts.
- 2 Make sure that the physical installation of the unit has been completed.
  - a Make sure that the compartment ("sonar room") is provided with ample ventilation to prevent system units from overheating.
  - b Make sure that the compartment ("sonar room") is clean and dry.
  - c Make sure that the bulkhead structure to which the Wide Band Transceiver (WBT) is fastened is substantial enough to hold the unit securely under all operating conditions.
  - d Make sure that ample ventilation is provided to avoid overheating.
  - e Make sure that you have free access to all the connectors on the Wide Band Transceiver (WBT) for maintenance purposes.
  - f Make sure that the bolts, screws or studs that have been used are all of the correct size.
  - g Make sure that the correct flat and shake-proof washers have been used.
  - h Make sure that all the nuts have been tightened properly.
  - i Make sure that all welds and brackets have been painted with the correct preservation medium to prevent corrosion.
- 3 Make sure that the unit is not physically damaged, and that the surfaces and paint-work are clean without dents or scratches.

The physical handling during the installation may have caused some minor scratches to the surfaces or paint-work. This can be accepted. However, if rough handling has caused serious damage, this must be recorded with a written statement and necessary photos, so that corrective actions can be made.
- 4 Make sure that the unit is firmly connected to ship's ground.
  - a Make sure that the unit is securely connected to the ship's ground with an earthing strap. The strap must be in addition to any incidental electrical contact made by the mounting lugs on the unit.
  - b Use a standard multimeter to check that the resistance between the unit and the ship's ground is approximately 0 (zero)  $\Omega$ .
- 5 Make sure that cable installation has been completed.
  - a Make sure that all cables leading to and from the unit have been properly mounted and secured.
  - b Make sure that enough slack has been provided on each cable to allow for maintenance and replacement.
- 6 Make sure that the unit has been identified with the relevant product label(s), and that one label includes the part and serial numbers.

## Result

Requirements	Results
The Wide Band Transceiver (WBT) is correctly installed with easy access for maintenance and replacement of parts.	
The Wide Band Transceiver (WBT) is free from scratches, dents or other physical damage.	
Free access to all the connectors on the Wide Band Transceiver (WBT) are provided. All cables connected to the Wide Band Transceiver (WBT) are properly mounted with enough slack.	
The welds and brackets that support the Wide Band Transceiver (WBT) are strong enough to hold the unit securely in place under all operating conditions. The welds and brackets have been painted with the correct preservation medium to prevent corrosion.	
The Wide Band Transceiver (WBT) is properly grounded.	
Date and signature:	

## Related topics

[Making sure that the EK80 is ready for operational use, page 188](#)

## Visual inspection of the WBT Cabinet

A visual inspection of the WBT Cabinet is required to verify that it has not been physically damaged during the installation.

### Prerequisites

The EK80 hardware units are installed as specified in this manual. The EK80 is turned off. You need the following equipment:

- Multimeter

### Procedure

- 1 Make sure that the WBT Cabinet is installed in the correct location, and that it is suitably oriented for easy maintenance and replacement of parts.
- 2 Make sure that the physical installation of the cabinet has been completed.
  - a Make sure that the compartment ("sonar room") is provided with ample ventilation to prevent system units from overheating.
  - b Make sure that the compartment ("sonar room") is clean and dry.
  - c If applicable: Make sure that the bulkhead structure to which the cabinet is fastened is substantial enough to hold it securely in place under all operating conditions.
  - d If applicable: Make sure that all welds and brackets have been painted with the correct preservation medium to prevent corrosion.

- e Make sure that the bolts, screws or studs that have been used are all of the correct size.
  - f Make sure that the correct flat and shake-proof washers have been used.
  - g Make sure that all the nuts have been tightened properly.
- 3 If the Wide Band Transceiver (WBT) units have been installed during the EK80 system installation:
- a Make sure that each drawer label has been positioned correctly and reflects the relevant transceiver.
  - b Make sure that all the power supplies have been installed on the dedicated bottom drawer(s).
  - c Make sure that all the power cables are fastened to the front vertical rail on the left side.
  - d Make sure that all the transducer cables are installed on the same side of the WBT Cabinet, and the opposite side of the power cables.
  - e Make sure that the entire installation allows for maintenance and replacements.

How to install the cables in the WBT Cabinet is described on drawing 444425. The drawing can be downloaded from our website. The drawing is also included on the EK80 USB.

- 4 Make sure that the cabinet is not physically damaged, and that the paint-work is clean without dents or scratches.
- The physical handling during the installation may have caused some minor scratches to the surfaces or paint-work. This can be accepted. However, if rough handling has caused serious damage, this must be recorded with a written statement and necessary photos, so that corrective actions can be made.
- 5 Make sure that the cabinet is firmly connected to ship's ground.
- a Make sure that the cabinet is securely connected to the ship's ground with an earthing strap. The strap must be in addition to any incidental electrical contact made by the mounting lugs on the cabinet.
  - b Use a standard multimeter to check that the resistance between the cabinet and the ship's ground is approximately 0 (zero)  $\Omega$ .
- 6 Make sure that the cabinet has been identified with the relevant product label(s).

## Result

Requirements	Results
The cabinet is correctly installed with easy access for maintenance and replacement of parts.	
The cabinet is clean and free from scratches, dents or other physical damage.	
All transceivers, power supplies and cables have been installed according to the drawing.	

Requirements	Results
The welds and brackets that support the cabinet are strong enough to hold the unit securely in place under all operating conditions. The welds and brackets have been painted with the correct preservation medium to prevent corrosion.	
The cabinet is properly grounded.	
Date and signature:	

### Related topics

[Making sure that the EK80 is ready for operational use, page 188](#)

## Visual inspection of the EC150-3C Power Supply Unit

A visual inspection of the Power Supply Unit is required to verify that the unit has not been physically damaged during the installation.

### Prerequisites

The EK80 hardware units are installed as specified in this manual. The EK80 is turned off. You need the following equipment:

- Multimeter

### Context

The purpose of the Power Supply Unit is to provide the EK80 with the necessary power for operation. The Power Supply Unit also controls the Ethernet communication between the transducer and the Processor Unit, as well as the synchronization with peripheral devices.

### Procedure

- 1 Verify that the Power Supply Unit is installed in the correct location, and that it is suitably oriented for easy maintenance and replacement of parts.
- 2 Make sure that the physical installation of the unit has been completed.
  - a Make sure that ample space is provided around the unit to allow for maintenance and replacement of parts.
  - b Make sure that the cabinet door can be fully opened for unrestricted access.
  - c Make sure that the bolts, screws or studs that have been used are all of the correct size.
  - d Make sure that the correct flat and shake-proof washers have been used.
  - e Make sure that all the nuts have been tightened properly.
  - f Make sure that all welds and brackets have been painted with the correct preservation medium to prevent corrosion.

- 3 Make sure that the unit is not physically damaged, and that the surfaces and paint-work are clean without dents or scratches.  
 The physical handling during the installation may have caused some minor scratches to the surfaces or paint-work. This can be accepted. However, if rough handling has caused serious damage, this must be recorded with a written statement and necessary photos, so that corrective actions can be made.
- 4 Make sure that the unit has been identified with the relevant product label(s), and that one label includes the part and serial numbers.
- 5 Make sure that the unit is firmly connected to ship's ground.
  - a Make sure that the unit is securely connected to the ship's ground with an earthing strap. The strap must be in addition to any incidental electrical contact made by the mounting lugs on the unit.
  - b Use a standard multimeter to check that the resistance between the unit and the ship's ground is approximately 0 (zero)  $\Omega$ .
- 6 Make sure that cable installation has been completed.
  - a Make sure that all cables leading to and from the unit have been properly mounted and secured.
  - b Make sure that enough slack has been provided on each cable to allow for maintenance and replacement.
- 7 Make sure that the unit is fitted with the correct fuse. (Rating: 6.3 A/230 VAC)

## Result

Requirements	Results
The Power Supply Unit is correctly installed with easy access for maintenance and replacement of parts.	
The Power Supply Unit is free from scratches, dents or other physical damage.	
Free access to all the connectors on the Power Supply Unit is provided. All cables connected to the Power Supply Unit are properly mounted with enough slack.	
The Power Supply Unit can be fully opened, and you have full access to the circuit boards and modules inside the unit.	
The welds and brackets that support the Power Supply Unit are strong enough to hold the unit securely in place under all operating conditions. The welds and brackets have been painted with the correct preservation medium to prevent corrosion.	
The Power Supply Unit is properly grounded.	
This unit is fitted with the correct fuse. (Rating: 6.3 A/230 VAC)	
Date and signature:	

## Related topics

[Making sure that the EK80 is ready for operational use, page 188](#)



# Turning on the EK80 for the first time

## Topics

[Setting up summary, page 199](#)

[Installing the EK80 operational software, page 201](#)

[Turning on the EK80 to \*Passive\* mode, page 202](#)

[Obtaining and installing the software license, page 203](#)

[Defining the IP address on the Processor Unit network adapter for communication with the transceiver, page 205](#)

[Installing one or more transducers, page 206](#)

[Installing transceiver channels, page 210](#)

[Adjusting the screen resolution, page 212](#)

## Setting up summary

Before a new EK80 Wide band scientific echo sounder can be put to use, it must be set up for operation.

### Prerequisites

- The EK80 Wide band scientific echo sounder system units have all been installed according to the instructions provided.
- All cables have been connected and verified.
- All system units have been inspected.
- The EK80 operational software is available.
- The EK80 software license is available.

### Caution

---

*You must never set the EK80 to "ping" unless the transducer is submerged in water. Most transducers are damaged beyond repair if they transmit in open air. Prevent inadvertent use of the EK80 whenever a transducer is not submerged.*

---

### Procedure

- 1 Do the following preparations.
  - a Turn on the Processor Unit.
  - b Make sure that you have administrative rights.
  - c Switch off any firewall applications.

- d Open the operating systems's *Network and Sharing Center*, and set the IP address for the network adapter used to communicate with the transceiver.
  - **IP Address:** 157.237.15.12  
Any address can be used, but 157.237.15.12 is recommended for legacy reasons. This is particularly important if your system contains old GPT transceivers.
  - **Subnet mask:** 255.255.255.0  
You can leave **Subnet mask** blank and select **OK**. When you see an error message saying that the message subnet mask is missing, select **OK** again. A default subnet mask is then automatically generated.
- 2 Install the EK80 operational software.
- 3 Turn on the transceiver(s).
- 4 Make sure that the Processor Unit is connected to the transceiver(s) using the Ethernet cable specified in the EK80 *Installation manual*.  
If you use more than one transceiver, a high performance Ethernet switch must be used.

**Note**

---

*It is very important that high-quality Ethernet cables are used. You must use CAT-5E STP (Shielded Twisted Pair) quality or better. If you use cables with lower bandwidth capacity you will reduce the EK80 performance.*

---

- 5 Start the EK80.
- 6 On the **Software License** page, install the software license(s).
- 7 On the **Transducer** page, install each transducer.
- 8 On the **Transceiver Installation** page, connect the transducer(s) to the transceiver(s).
- 9 On the **Sensor Installation** page, set up the interfaces to the navigation sensors.
- 10 In the **Environment** dialog box, select correct water temperature and salinity.
- 11 Start normal operation.
  - a On the **File Setup** page, define the recording parameters.
  - b Set **Operation** to *Normal*.
  - c In the **Normal Operation** dialog box, set the operating parameters.
  - d Set **Ping Mode** to *Interval*.
  - e With the **Ping Interval** function, specify the ping rate that has been defined for the survey.
  - f Set **Ping** to *On*.

### Further requirements

To obtain quantitative data, the EK80 must be calibrated.

Observe the summary procedure, and the complete description, in the EK80 *Reference manual* and on-line help.

### Related topics

[Turning on the EK80 for the first time, page 199](#)

[Setting to work, page 185](#)

## Installing the EK80 operational software

If your EK80 Wide band scientific echo sounder is provided with a Processor Unit, the EK80 software has already been installed. If you intend to use your own computer, you must install the software yourself.

### Context

One or more valid software licenses are required to operate the EK80. The software licenses are installed after the EK80 software installation. The **Software License** page is provided for this purpose.

### Note

---

*Make sure that you have administrative rights on the Processor Unit. You need this to install the software. If you purchased your own computer, you must verify that it meets the technical requirements for use with the EK80. Do this before you install the software.*

---

### Procedure

- 1 Turn on the Processor Unit.
- 2 Switch off any firewall applications.
- 3 Insert the EK80 software media.
- 4 Use a file manager application on the Processor Unit to access the software files.
- 5 Double-click `Setup.exe` to start the installation.

### Note

---

*If the operating system on your computer is not supported, the installation will stop with an error message. You must then upgrade your computer - or use a different one - to complete the software installation.*

---

- 6 Allow the installation wizard to run. Follow the instructions provided.

We recommend that you install the software in the default folder suggested by the wizard. In the last dialog box you are permitted to remove old settings. Since this is your first installation of the software, you can disregard this option.

- 7 Once the software installation has been completed, double-click the icon on the desktop to start the program.
- 8 Depending on your operating system parameters, certain dialog boxes may open.
  - a The Windows® Firewall may open a dialog box requesting information about the network. Select **Public**, and then select **Allow access**.
  - b The operating system may also open other dialog boxes to verify that the EK80 software can run on the computer. You must permit this.

### Further requirements

Observe the dedicated procedures for obtaining and installing the software licence(s).

### Related topics

[Turning on the EK80 for the first time, page 199](#)

[Setting to work, page 185](#)

## Turning on the EK80 to *Passive* mode

In order to use the EK80, you must first turn it on. In this situation we do not want the EK80 to transmit, so we will leave it in *Passive* mode.

### Prerequisites

This procedure assumes that the entire EK80 installation has been inspected. All power sources have been measured and verified. All system cables and connectors have been checked and tested. The EK80 has been installed on the Processor Unit.

### Context

The program is not automatically started when the Processor Unit is turned on. Once the operating system has started, select the program icon on the desktop.

When the EK80 is turned on and set to *Normal* operating mode, it will use the transducer to transmit acoustic pulses into the water.

### Caution

---

*You must never set the EK80 to "ping" unless the transducer is submerged in water. Most transducers are damaged beyond repair if they transmit in open air. Prevent inadvertent use of the EK80 whenever a transducer is not submerged.*

---

### Procedure

- 1 Make sure that each transceiver is turned on.
- 2 Turn on the display.

If required, refer to the instructions provided by the display manufacturer.

- 3 Turn on the Processor Unit.  
Wait while the operating system loads.
- 4 On the Processor Unit desktop, double-click the EK80 icon to start the program.
- 5 Select user settings.  
During the program load, a dialog box appears to let you choose from the current user settings available on the EK80. The dialog box is only visible a few seconds. You do not need to make a choice here. You can select your predefined user setting at any time by means of the **User Settings** dialog box on the **Main** menu.
- 6 Once the EK80 program has started, observe that the presentation fills the entire screen.

### Related topics

[Turning on the EK80 for the first time, page 199](#)

[Setting to work, page 185](#)

## Obtaining and installing the software license

To operate the EK80 with a transceiver you need a valid software license. Before you can use the EK80 you must obtain a "license string" and install it on your Processor Unit. Without a license you will not be able to communicate with the transceiver.

### Prerequisites

This procedure assumes that the EK80 operating software has been successfully installed on the Processor Unit.

### Context

The software license is a 32 character hexadecimal string based on the transceiver's serial number. It defines several key parameters that control the functionality and behaviour of the transceiver(s) you use. Each software license code "unlocks" one transceiver for operational use with a set of predefined properties.

The software license is not linked to the physical Processor Unit. You can therefore easily move the software from one computer to another, just remember to make a copy of the license string.

### Note

---

*Once you receive your software license string(s), do not lose them. We suggest that you copy the information into a text file (for example Notepad), and add relevant information. Place the text file on the Processor Unit desktop, and make sure that backup copies are made.*

---

In order to obtain a software license you must contact a Simrad dealer or distributor. You can also use the request form on <https://www.simrad.com/support>, or contact our support department directly.

Note

---

*This information is only valid if your EK80 is meant to operate with one (or more) of the following transceivers:*

- *Wide Band Transceiver (WBT)*
  - *WBT Tube*
  - *WBT Mini*
  - *EC150-3C*
- 

**Procedure**

- 1 Obtain the necessary information about your transceiver(s) and transducer(s). Write down:
  - a The serial number for each transceiver.
  - b The beam type.
  - c Which transducers you have connected to each transceiver.
- 2 Send the necessary information to one of Simrad's dealers or distributors. You can also use the request form on <https://www.simrad.com/support>, or contact our support department directly.

You can use the following e-mail address:

- [purchase.order@simrad.com](mailto:purchase.order@simrad.com)

Once the software license string(s) have been returned to you (most likely by e-mail), you can install the licenses into the software.

- 3 On the **Setup** menu, select **Installation**.

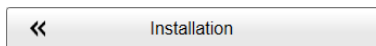

Observe that the **Installation** dialog box opens. This dialog box contains a number of pages selected from the menu on the left side.

- 4 On the left side of the **Installation** dialog box, select **Software License**.

Observe that the **Software License** page opens.

- 5 Select **Type License String**, and type the license string into the dialog box.

If you do not have a computer keyboard connected to your EK80 system, select the **Keyboard** button to open an on-screen keyboard. If you have received the license string on an electronic format (e-mail or text file), you can copy the string from the source document and paste it into the **Type License String** dialog box.

- 6 Select **OK** to save the license string and close the **Type License String** dialog box.
- 7 Verify that the license string is placed in the **Currently active licenses** list.  
If necessary, select the license string on the left side, and click the arrow button [ > ] to move it to the **Currently active licenses** list.
- 8 Select **Apply** and then **Close** to save all the parameters and close the **Installation** dialog box.

### Related topics

[Turning on the EK80 for the first time, page 199](#)

[Setting to work, page 185](#)

## Defining the IP address on the Processor Unit network adapter for communication with the transceiver

The Processor Unit and the transceiver(s) communicate on a high capacity Ethernet cable. If more than one transceiver is used, an Ethernet switch is added. On the Processor Unit, define the IP address and Subnet mask for the Ethernet port used to communicate with the transceiver(s). The EK80 automatically assigns an IP address to each transceiver when they are turned off and on.

### Prerequisites

This procedure is made for the Microsoft® Windows® 10 operating system. It is assumed that you are familiar with this operating system.

### Context

As long as you do not change the Processor Unit to another computer, or replace the network adapter in your Processor Unit, you will only need to do this once.

### Procedure

- 1 On the Processor Unit, close the EK80 program.
- 2 Open the **Network Connections** dialog box.
  - a In the bottom-left corner of your desktop, select the Windows® search function.
  - b In the search box, type "Network Connections", and open the **Network Connections** dialog box.
- 3 Right-click the network adapter you are going to use and select **Properties** on the shortcut menu.
- 4 On the list of connections, select **Internet Protocol 4 (TCP/IPv4)**, and then **Properties**.
- 5 Select **Use the following IP address**, and type the IP address and network mask.
  - **IP Address:** 157.237.15.12

Any address can be used, but 157.237.15.12 is recommended for legacy reasons. This is particularly important if your system contains old GPT transceivers.

- **Subnet mask:** 255.255.255.0

You can leave **Subnet mask** blank and select **OK**. When you see an error message saying that the message subnet mask is missing, select **OK** again. A default subnet mask is then automatically generated.

- 6 Select **OK** to save the selected settings, and then close all the dialog boxes.
- 7 Start the EK80 program.
- 8 Open the **Transceiver Installation** page.
  - a Open the **Setup** menu.
  - b On the **Setup** menu, select **Installation**.
  - c On the left side of the **Installation** dialog box, select **Transceiver**.
- 9 Under **Transceiver Browsing** insert the IP Address that you just specified for the Ethernet adapter.
- 10 At the bottom of the page, select **Apply** to save your settings.
- 11 Turn each transceiver off and on.

This forces the EK80 to assign new IP addresses within the selected IP range.

### Related topics

[Turning on the EK80 for the first time, page 199](#)

[Setting to work, page 185](#)

## Installing one or more transducers

The transducers you wish to use with the EK80 must be "installed" as a part of the software configuration. Which transducers to use depends on the number of transceivers in your system, and the licenses you have for these. Unless you replace a broken transducer, or add a new, you only need to do this once.

### Prerequisites

It is assumed that the EK80 software has been installed, and that all relevant license strings have been applied. You need to know the type and serial number of each transducer that you wish to install.

### Context

Each transducer is added using the **Transducer Installation** page. The **Transducer Installation** page is located in the **Installation** dialog box.

You can only choose a transducer from the **Model** list. The list is generated from a system file on your Processor Unit. It contains all the transducers that are compatible with the transceiver(s) you have. The list also includes technical specifications for each



transducer. You can not see this information, but it is used by the EK80 to set up the operational parameters. This allows each transceiver to optimise its performance for the individual transducer models.

If you cannot find your transducer in the list, contact you dealer, agent or Kongsberg Maritime to upgrade the relevant software component in the EK80.

#### Note

---

*Just making changes and selecting **OK** at the bottom of the page will not install anything. Select what to install, define the relevant parameters, and then select **Add**.*

---

If your EK80 shall only be used with an ADCP transceiver for current profiling, you do not need to install other transducers.

#### Procedure

- 1 Open the **Setup** menu.
- 2 On the **Setup** menu, select **Installation**.

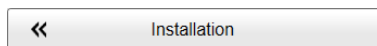

Observe that the **Installation** dialog box opens. This dialog box contains a number of pages selected from the menu on the left side.

- 3 On the left side of the **Installation** dialog box, select **Transducer Installation**.
- 4 Select the transducer you wish to install from the **Model** list.

#### Note

---

*Make sure that you select a transducer that is supported by your current license.*

---

- 5 Insert the serial number.

This serial number is very important, because you will need it as a reference identification when the EK80 is calibrated. Some new Simrad transducers with built-in "intelligence" will automatically provide this serial number.

- 6 Type the name you wish to use into the **Custom Name** box.

Type any name that you wish to use to identify the transducer. The name you select will only be used to identify the transducer in other dialog boxes. It is not used in the echo data that you export. If you do not have a computer keyboard connected to your EK80 system, select the **Keyboard** button to open an on-screen keyboard.

- 7 Select mounting method.
- 8 Specify the orientation of the transducer beam.
- 9 If relevant for your transducer installation, provide the accurate physical location of the transducer with reference to the vessel's coordinate system.

Note

---

*These settings are intended for the installation of an ADCP transceiver for current profiling. The information is not used to adjust for installation misalignments, but will be included in the RAW files for post-processing purposes.*

---

Use the centre of the transducer face as reference, and define the offset values related to the *Ship Origin*.

- a Select the offset value on the X axis (fore-and-aft direction) from the *Ship Origin*. Adjust with a positive value for X if the transducer is located ahead of the ship origin.
  - b Select the offset value on the Y axis (athwartship) from the *Ship Origin*. Adjust with a positive value for Y if the transducer is located on the starboard side of the ship origin.
  - c Select the offset value on the Z axis (vertical) from the *Ship Origin*. Adjust with a positive value for Z if the transducer is located under the ship origin.
- 10 If relevant for your transducer installation, provide the rotation angles.

Note

---

*These settings are intended for the installation of an ADCP transceiver for current profiling. The information is not used to adjust for installation misalignments, but will be included in the RAW files for post-processing purposes.*

---

- a Obtain the rotation (angle) information from the personnel that installed the transducer.
- b Insert the values.
  - Specify an angle (in degrees) to compensate for any deviation from the X axis (fore-and-aft direction) in the coordinate system.
  - Specify an angle (in degrees) to compensate for any deviation from the y-axis (athwartship direction) in the coordinate system.
  - Specify an angle (in degrees) to compensate for any deviation from the Z axis (vertical direction) in the coordinate system.

Keep in mind that in its default position (all axis set to 0 (zero)) the transducer points straight down with the orientation mark (arrow) pointing forward. This default position must always be used as reference for rotation adjustments. To set the angles correctly, observe this exercise.

- 1 Start with the transducer in its default position: The transducer face is horizontal facing down, and the indicator arrow is pointing straight forward.
- 2 If the transducer is properly installed without unintentional skew, the **Rotation around X** can also be set to 0 (zero).

3 Lift the front end of the transducer up, so that the indicator arrow moves up. This is a **Rotation around Y**.

4 Proceed until the requested angle has been reached.

*Example:* If a 30-degree Y angle is requested, the **Rotation around Y** must be set to 60 degrees (that is the angle from the default position). Since the transducer is pointing straight forward, the **Rotation around Z** value is 0 (zero).

5 From this raised position, turn the transducer towards starboard. The indicator arrow is still pointing up. This is a **Rotation around Z**.

6 Proceed until the requested angle has been reached.

*Example:* If a 90-degree Z angle is requested, the **Rotation around Z** must be set to 90 degrees (that is the angle from the forward position).

11 Select **Add** to save the information you have provided.

The transducer is added to the list in the **Installed Transducers** box.

12 Repeat for each transducer that you wish to install.

13 Continue your work in the **Installation** dialog box, or select **OK** to close it.

## Result

Once a transducer has been installed, it is listed in the **Installed Transducers** box. To see the information you have collected about the transducer, select the relevant transducer in the list.

The **Edit** functionality on the **Transducer Installation** page makes it possible to change the information you have provided for the transducer. You cannot change the model identification and the serial number. The custom name is used several places in the user interface, and it can be changed.

The **Remove** functionality on the **Transducer Installation** page makes it possible to delete the information you have provided for the transducer. There is no "undo" functionality.

## Related topics

[Turning on the EK80 for the first time, page 199](#)

[Setting to work, page 185](#)

## Installing transceiver channels

In order to use the EK80, the Processor Unit must be connected to one or more transceivers, and each of them must in turn be connected to one or more transducers. Each channel must be installed before it can be put to use. In this context, the phrase *channel* is used as a common term to identify the combination of transceiver, transducer and operating frequency.

### Prerequisites

The EK80 is installed as specified in the EK80 *Installation manual*. All units are turned on.

- All cables are connected and tested.
- The software license for each transceiver is installed and activated.
- The Ethernet adapter in the Processor Unit is set up with a unique IP address.
- All relevant transducers are installed using the **Transducer Installation** page.

### Context

The **Transceiver Installation** parameters control the installation and disconnection of transceivers. Every time the page is opened, the EK80 software automatically performs a search on the Ethernet network for transceivers.

The list in the upper part on the **Transceiver Installation** page shows you an overview of the transceivers and channels that are currently available. In this context, the phrase *channel* is used as a common term to identify the combination of transceiver, transducer and operating frequency. Each channel is identified by the transceiver type and serial number and the transducer(s) in use. The current status for each channel is also provided.

- **Busy:** The channel is already in use, probably by another echo sounder on the same network. You cannot connect to this channel.
- **Installed:** This channel is connected to your EK80 system.
- **Lost:** This channel cannot be used.
- **Available:** This channel is vacant and ready for use.

### Note

---

*When you work in the **Installation** dialog box, you must always select **Apply** to save the changes made on a page. You must do this before you continue working on a different page.*

---

### Procedure

- 1 On the **Setup** menu, select **Installation**.



Observe that the **Installation** dialog box opens. This dialog box contains a number of pages selected from the menu on the left side.

- 2 On the left side of the **Installation** dialog box, select **Transceiver**.
- 3 Install the channel(s).
  - a Observe that the transceiver(s) you have connected to the Processor Unit are listed.

Each transceiver is identified with type and serial number. The available channels on each transceiver are listed separately.

- b For each channel, choose which transducer to connect to.

The list of transducers available for installation is defined by those you installed on the **Transducer** page.

**Note** \_\_\_\_\_

*This is a critical task. Make sure that the correct transducer is selected.*

---

- c At the bottom of the page, select **Apply** to save your settings.
  - d Observe that the status for the relevant frequency channels change to *Installed*.

**Tip** \_\_\_\_\_

*If no transceivers are listed:*

- 1 Select **Browse** in the **Transceiver Browsing** box, and open the **Local IP Address** box.

- 2 Select the correct address for the Ethernet adapter you are using. Select **Apply**.

*This will make the EK80 search the network for available transceivers.*

- 3 Turn each transceiver off and on.

*The EK80 automatically assigns an IP address to each transceiver when they are turned off and on.*

*Select **Browse**.*

- 4 Verify that the Ethernet communication between the units is operational.

- 5 If you are using an Ethernet switch, make sure that it works.

- 6 If you have changed the network settings, turn each transceiver off and on.

*The EK80 automatically assigns an IP address to each transceiver when they are turned off and on.*

---

- 4 At the bottom of the page, select **Apply** to save your settings.

- 5 Repeat until all the channels have been installed.

- 6 Continue your work in the **Installation** dialog box, or select **OK** to close it.

## Result

When all channels have been installed, you can start normal operation.

### Caution

---

*You must never set the EK80 to "ping" unless the transducer is submerged in water. Most transducers are damaged beyond repair if they transmit in open air. Prevent inadvertent use of the EK80 whenever a transducer is not submerged.*

---

## Related topics

[Turning on the EK80 for the first time, page 199](#)

[Setting to work, page 185](#)

## Adjusting the screen resolution

Some computers have graphic adapters that are not able to detect the resolution of the current display. This limitation can also be caused by the display cable, or by imperfections in a display matrix system. In such cases, you must use the functionality of the operating system to adjust the screen resolution.

### Prerequisites

This procedure is made for the Microsoft® Windows® 7 and 10 operating systems. It is assumed that you are familiar with these operating systems.

### Context

As a general recommendation, you should set the screen resolution as high as possible. This will allow you more "space" in the EK80 presentation to offer more detailed information. The physical width of your top bar will also be extended, and free space for icons and navigational information.

Unless you change the hardware (computer, graphic adapter or display), you will only need to do this once.

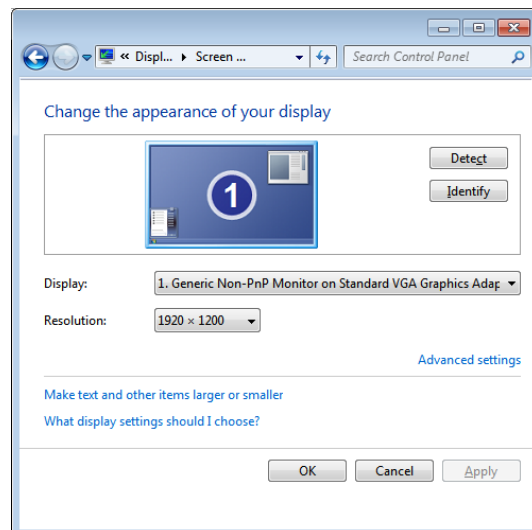

### Procedure

- 1 On the Processor Unit, close the EK80 program.
- 2 This procedure is made for the Microsoft® Windows® 7 operating system.
  - a In the bottom-left corner of your desktop, select the Windows® **Start** button.
  - b On the right-hand side of the **Start** menu, select **Control Panel**.

- c Observe that the Control Panel opens.
  - d In the **Control Panel** dialog box, under **Appearance and Personalization**, select **Adjust screen resolution**.
  - e Change the display settings.
    - 1 Make sure that the correct display is shown.
    - 2 Change the resolution to maximum permitted resolution for the display.
    - 3 Select **OK**.
    - 4 Observe that the screen resolution changes.
    - 5 If you are satisfied with the new resolution, select **Keep changes** in the acknowledge dialog box.
  - f Click the [**X**] in the top right corner to close the Control Panel.
- 3 This procedure is made for the Microsoft® Windows® 10 operating system.
- a In the bottom-left corner of your desktop, select the Windows® **Start** button.
  - b On the menu, select **Settings**.
  - c Observe that the **Windows Settings** dialog box opens.
  - d Select **System** in the top left corner of the **Windows Settings** dialog box.
  - e On the left side of the dialog box, select **Display**.
  - f Change the display settings.
    - 1 Make sure that the correct display is shown.
    - 2 Change the resolution to maximum permitted resolution for the display.
    - 3 Select **OK**.
    - 4 Observe that the screen resolution changes.
    - 5 If you are satisfied with the new resolution, select **Keep changes** in the acknowledge dialog box.
  - g Select [**X**] in the top right corner to close the **Windows Settings** dialog box.

**Related topics**

[Turning on the EK80 for the first time, page 199](#)

[Setting to work, page 185](#)

# Installing and troubleshooting Network Time Protocol (NTP)

NTP (Network Time Protocol) is a network protocol that enables you to synchronize the clocks on devices over a network. It uses one or more *NTP servers* to maintain a highly accurate time, and allows clients to query for this time. When clients query the server they automatically adjust their own internal clocks to mirror the NTP server. These tasks are only applicable for a EK80 system fitted with relevant hardware for acoustic Doppler current profiler (ADCP) functionality.

## Topics

[Installing Network Time Protocol \(NTP\), page 214](#)

[Installing Network Time Protocol \(NTP\) monitor, page 218](#)

[Troubleshooting the Network Time Protocol \(NTP\) service, page 222](#)

## Installing Network Time Protocol (NTP)

NTP (Network Time Protocol) is a network protocol that enables you to synchronize the clocks on devices over a network. It uses one or more *NTP servers* to maintain a highly accurate time, and allows clients to query for this time. When clients query the server they automatically adjust their own internal clocks to mirror the NTP server. The Network Time Protocol (NTP) application must be installed on the EK80 Processor Unit.

## Prerequisites

To download the software you need a computer connected to the Internet.

## Context

Installing an Network Time Protocol (NTP) application is a requirement if your EK80 Processor Unit is connected to acoustic Doppler current profiling (ADCP) hardware. The EK80 requires synchronized reception of the KM Binary datagram. The NTP application ensures that the EK80 and the ADCP hardware are synchronized to the vessel's master clock.

## Note

---

*The screen captures are taken from software version 4.2.8. The manufacturer may change these in later releases.*

---

## Procedure

- 1 Open a web browser.



- 2 Type the following URL in the address field:  
<https://www.meinbergglobal.com/english/sw/ntp.htm>
- 3 Download and install the latest release of the NTP application.  
"NTP for Windows XP and newer, with IPv6 support"  
Example: ntp-4.2.8p14-win32-setup.exe
- 4 Select **I agree** for license agreement.

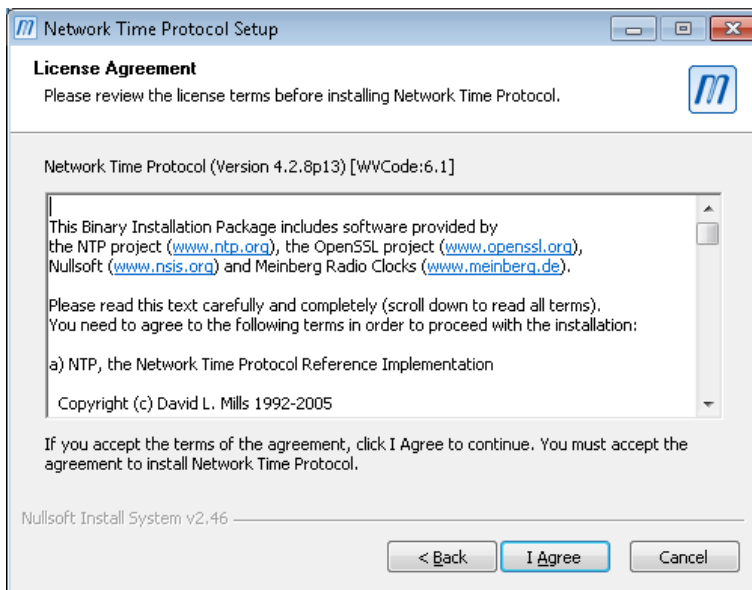

- 5 Keep the suggested **Destination Folder** for **Installation Location**.

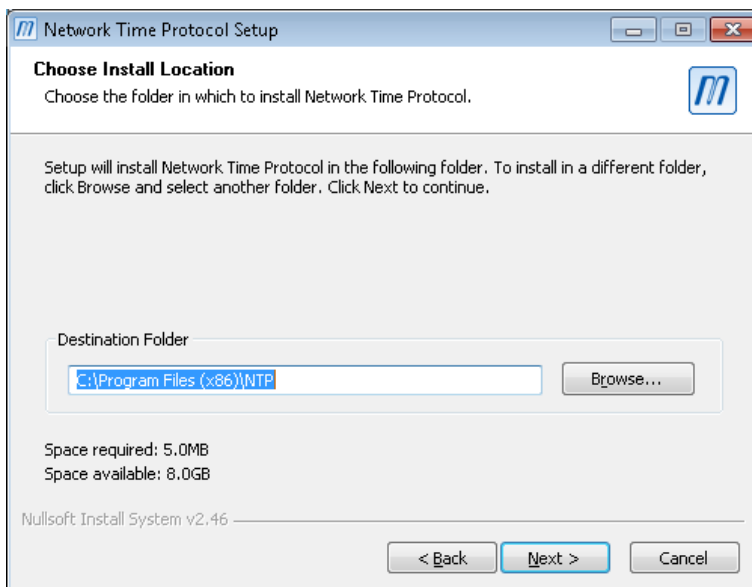

Select **Next** to continue.

- 6 Select **Installation Components**.

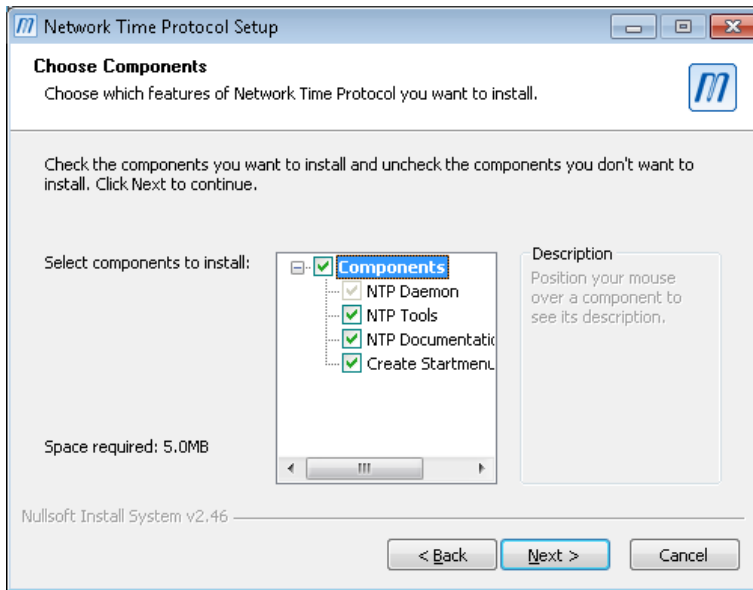

Select the following options by checking the check boxes:

- **NTP Dameon**
- **NTP Tools**
- **NTP Documentation**
- **Create Start menu**

Select **Next** to continue.

7 Select configuration file settings.

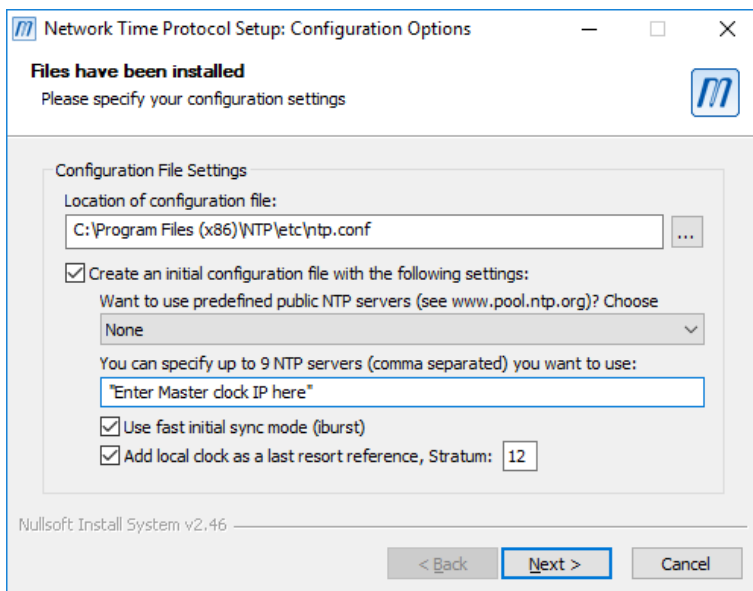

Select the following options by checking the check boxes:

- **Location of configuration file:** C:\Program Files (x86)\NTP\etc\ntp.conf

- **Create an initial configuration file with the following settings**
- **Predefined public NTP servers: None.**
- **Specify the NTP server IP address: 10.124.24.200** (Use the IP address of your Master clock, this is an example)
- **Use fast initial sync mode (iburst)**
- **Add local clock as a last resort reference, Stratum: 12**

Select **Next** to continue.

- 8 Select **No** for not reviewing the generated config file.

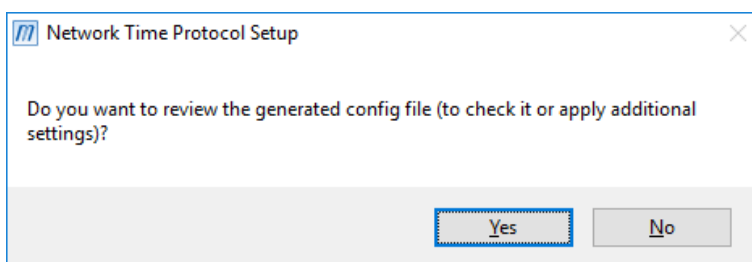

- 9 Select service settings in the **Setting up NTP service** page.

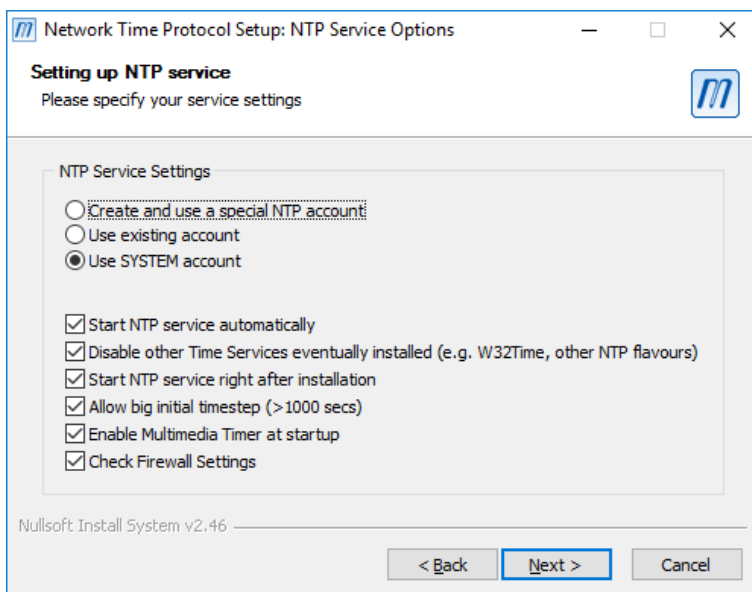

Select the following options by checking the check boxes:

- **SYSTEM account**
- **Start NTP service automatically**
- **Disable other Time Services eventually installed (e.g. W32Time, other NTP flavours)**
- **Start NTP service right after installation**
- **Allow big initial timestep (<1000 s)**
- **Enable Multimedia Timer at startup**

- **Check Firewall Settings**

Select **Next** to continue.

10 Select **Finish** to close the wizard.

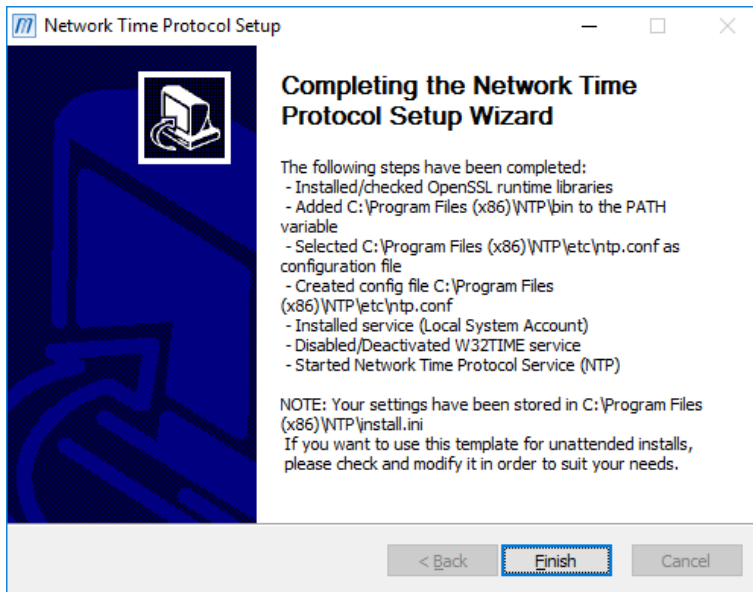

### Related topics

[Installing and troubleshooting Network Time Protocol \(NTP\), page 214](#)

## Installing Network Time Protocol (NTP) monitor

The NTP Server Monitor is a software utility that runs on any Windows platform, workstation or server. It allows any number of NTP time servers to be constantly monitored. Any servers that are operating outside the preset tolerances are highlighted in the user interface.

### Prerequisites

To download the software you need a computer connected to the Internet.

### Context

The NTP Time Server Monitor allows you to configure and control the local NTP service. The current status of the local NTP service, as well as external NTP services, are displayed.

The NTP Timer server monitor software controls and oversees the NTP Service. It further simplified the handling of the NTP service.

Here is a small list of the abilities and features this tool offers:

- Switch between different configurations (ntp.conf files).

- Change the service settings without the need to open the device manager each time.
- Extract the NTP related application log entries and display them separately in a table.
- Display the current status of the running NTP service.
- The user can configure external NTP server, which are also queried by the NTP time server displayed.
- The configuration file of the NTP service (ntp.conf) can be edited within this program.

*<https://www.meinbergglobal.com/english/sw/ntp-server-monitor.htm> (June 2020)*

---

**Note**

*The screen captures are taken from software version 1.04. The manufacturer may change these in later releases.*

---

**Procedure**

- 1 Open a web browser.
- 2 Type the following URL in the address field:  
<https://www.meinbergglobal.com/english/sw/ntp-server-monitor.htm>
- 3 Download and install the latest release of the NTP application.  
"NTP Time Server Monitor for Windows NT/2000/XP/Server 2003, Server 2008/Vista/7/8"  
Example: ntp-time-server-monitor-1.04.exe

4 Select **Destination Folder**

C:\Program Files (x86)\meinberg\ntp\_time\_server\_monitor

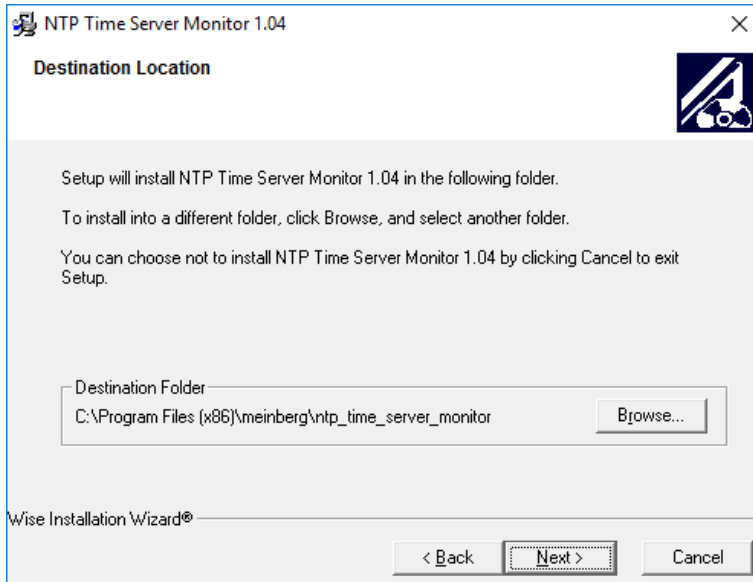

Select **Next** to continue.

5 Type the name of the **Program Manager Group**.

**Meinberg**

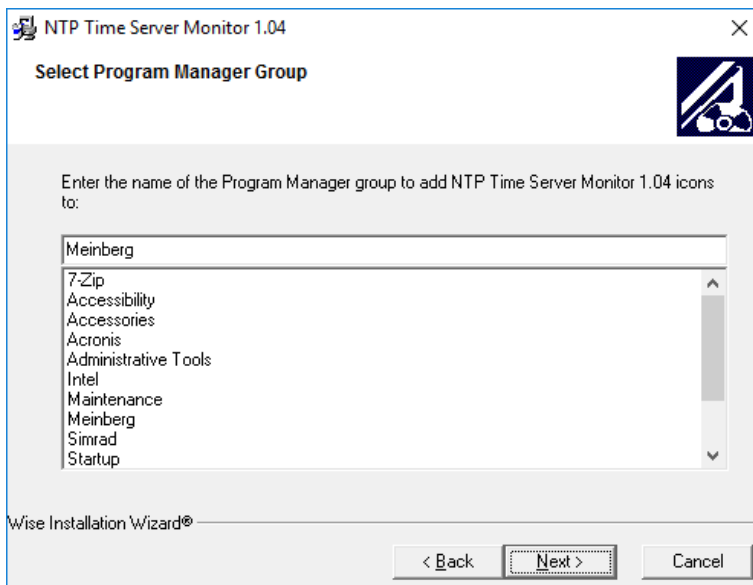

Select **Next** to continue.

- 6 Start the installation by selecting **Next**.

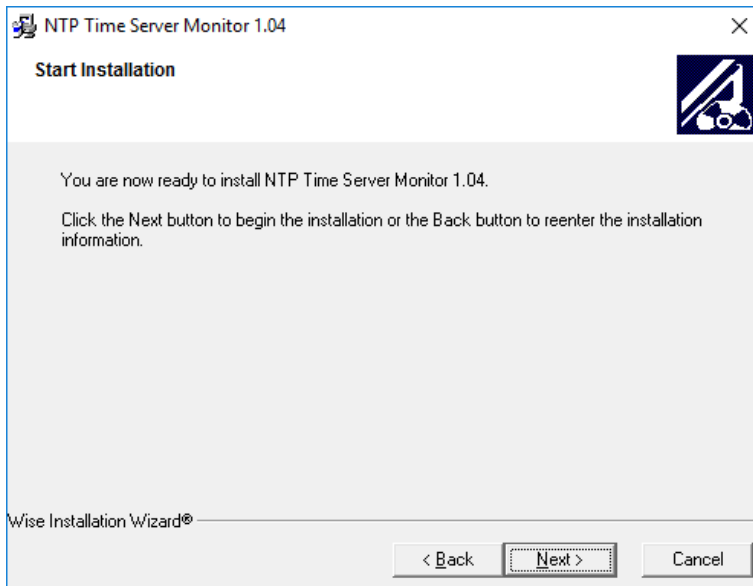

- 7 Select **Finish** to close the wizard.

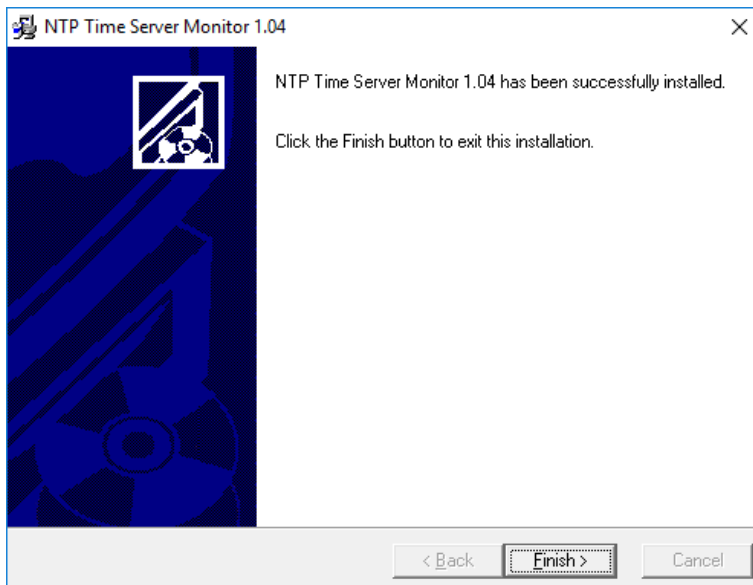

8 Start NTP Time Server Monitor from the desktop.

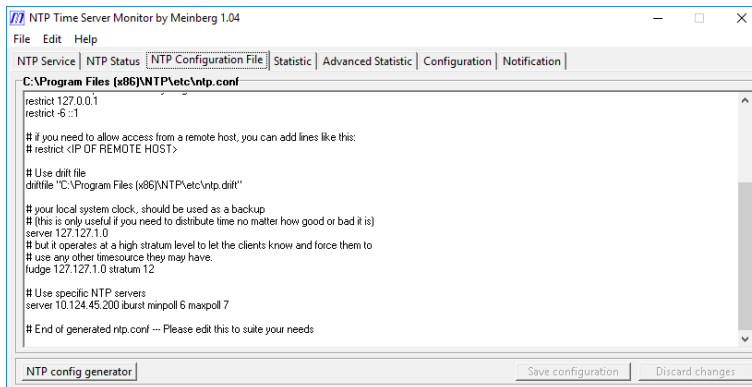

9 Verify that the NTP service operates normally.

- a Make sure that the service is in *Started* mode on the **NTP Service** tab.
- b Make sure that the IP addresses and synchronized device are in *OK* mode on the **NTP Status** tab.
- c Make sure that the NTP server provides NTP timing signals to the relevant ADCP hardware in the **NTP Configuration File** tab.
  - The master clock is found at IP address 10.124.45.200 (example).
  - The NTP server will also update the EK80 Processor Unit clock.
  - In some cases a motion reference unit (MRU) providing the KM Binary datagram does *not* act as the vessel’s master clock. You must then follow the instructions of the MRU manufacturer to synchronize the MRU to the Ship Master clock.

**Related topics**

[Installing and troubleshooting Network Time Protocol \(NTP\), page 214](#)

**Troubleshooting the Network Time Protocol (NTP) service**

The Network Time Protocol (NTP) service may in some cases malfunction, or even stop.

**Context**

The EK80 installation program adds a firewall rule to allow for NTP communication. If the EK80 issues messages related to missing time synchronization between a motion reference unit (MRU) and/or ADCP hardware synchronization, the problem is most likely related to the firewall.

**Procedure**

- 1 Check the firewall settings on the Processor Unit.

One reason for NTP synchronisation problems may be a firewall or port filter that inhibit the communication. Check the firewall settings in the Control Panel.



- 2 Adjust the firewall settings.
- 3 Check the communication between the EK80 NTP server and the client(s).

Tip

---

*You can use Wireshark (<https://www.wireshark.org>). This is a network protocol analyser. Wireshark allows you to see your network activities at a microscopic level.*

---

### **Related topics**

[Installing and troubleshooting Network Time Protocol \(NTP\), page 214](#)

# Configuring the EK80 for normal operation

## Topics

[Selecting menu language, page 224](#)

[Selecting measurement units, page 225](#)

[Defining the raw data recording parameters, page 225](#)

## Selecting menu language

You may prefer to use the EK80 with a user interface in your own language. The **Language** function allows you to select the language to be used in the EK80 presentations, menus and dialog boxes.

### Context

With a few exceptions, the chosen language will also be used for all other text on the EK80. The EK80 help may not be available for the language you choose. If your language is not supported, the English help is provided.

### Procedure

- 1 Open the **Setup** menu.
- 2 Select the middle of the **Language** button to open the list of available options.



- 3 Select the language you wish to use.

### Result

All the texts in the user interface are changed to the selected language.

The context sensitive on-line help may also be available in your language. To change the language in the on-line help, you may need to restart the EK80.

### Related topics

[Configuring the EK80 for normal operation, page 224](#)

[Setting to work, page 185](#)

## Selecting measurement units

The EK80 is prepared to work with several international standards for units of measurements. From the **Units** page you control which units of measurements that are used.

### Context

The EK80 user interface presents many measurements. These measurements are for example related to depth, range and distance. Use the **Units** options to select the units of measurements you want to work with. The EK80 uses them in all presentations. You only need to define them once.

### Note

---

*When you work in the **Installation** dialog box, you must always select **Apply** to save the changes made on a page. You must do this before you continue working on a different page.*

---

### Procedure

- 1 On the **Setup** menu, select **Installation**.

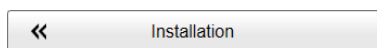

Observe that the **Installation** dialog box opens. This dialog box contains a number of pages selected from the menu on the left side.

- 2 On the left side of the **Installation** dialog box, select **Units**.

Observe that the **Units** page opens.

- 3 Adjust the setting to fit your requirements.
- 4 At the bottom of the page, select **Apply** to save your settings.
- 5 Continue your work in the **Installation** dialog box, or select **OK** to close it.

### Related topics

[Configuring the EK80 for normal operation, page 224](#)

[Setting to work, page 185](#)

## Defining the raw data recording parameters

The EK80 allows you to record both raw and processed echo data. The data are saved on the Processor Unit hard disk, or on an external data storage device, according to the preferences you have defined.

### Context

**File Setup** controls how and where the recorded files are saved on the Processor Unit hard disk, or on an external storage device. By adding a prefix to the file names you

can identify the files you have recorded during a specific mission or survey. You can also define a maximum size of the files.

Tip

---

*The data files will normally become very large. If you wish to record large amounts of EK80 data, make sure that you have enough space on your hard disk. Unless your Processor Unit is equipped with a very large disk, we recommend that you save the data to an external storage device.*

*Set up the file and folder parameters before you start the recording. If you wish to save your recorded data on an external hard disk, make sure that it is connected to the Processor Unit.*

*If the current file size gets too big during recording, select **Split File** on the **Record RAW** button. This will close the current file, and then automatically continue recording to a new file. **Record RAW** is located on the **Operation** menu.*

---

## Procedure

- 1 Open the **Operation** menu.
- 2 Select **Output**.

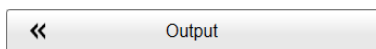

Observe that the **Output** dialog box opens. This dialog box contains a number of pages selected from the menu on the left side.

- 3 In the **Output** dialog box, select **File Setup**.
- 4 On the **File Setup** page, define the recording parameters.
  - a Define the output directory for the recorded files.

In order to change the output directory, both **Record RAW** and **Record Processed** recording must be set to *Off*. The same folder is used for both raw and processed files.

- b Define a file name prefix.

By adding a prefix to the file names you can identify the files you have recorded during a specific mission or survey.

- c Define the maximum amount of bytes to be contained in one data file.

Select **Maximum** for 1 GB file size.

The current size of the RAW data file is displayed during data recording. If the current file size gets too big during recording, select **Split File** on the **Record RAW** button. **Record RAW** is located on the **Operation** menu.

- d Specify the raw data recording parameters.

The **Range** setting defines the vertical or horizontal distance from where the echo presentation starts to the end of the search area.

- Select **Common** to use the same recording range for all your active channels.
- Select **Auto** to allow the EK80 to automatically find the required range value.
- Select **Individual** to use the different recording ranges for your active channels.

The **Stored sampled data for WBTs running CW** options can be used to reduce the amount of recorded data when you are using a Wide Band Transceiver (WBT) with CW pulses.

- Select **Complex samples** to use the default data format.
- Select **Power/Angle** to reduce the file sizes.
- Select **Reduced sampling rate Power/Angle samples** to minimize the file sizes.

**Note** \_\_\_\_\_

*Unless you choose **Complex samples** your RAW data files will contain less information.*

---

The **Motion Data Recording** function allows you to control how often the motion data are saved in the raw data file.

- 5 At the bottom of the page, select **Apply** to save your settings.
- 6 Select **OK** to close the dialog box.

**Related topics**

[Configuring the EK80 for normal operation, page 224](#)

[Setting to work, page 185](#)

## Interfacing peripheral equipment

### Topics

- [Installing navigation sensors and other sensors, page 228](#)
- [Defining the serial and Ethernet \(LAN\) port parameters, page 230](#)
- [Setting up the input from a navigation system \(GPS\), page 231](#)
- [Configuring the sensor interface, page 234](#)
- [Setting up a serial or LAN \(Ethernet\) port for annotation input, page 235](#)
- [Connecting a catch monitoring system to a serial or LAN \(Ethernet\) port, page 237](#)
- [Connecting a trawl system to a serial or LAN \(Ethernet\) port, page 239](#)
- [Setting up the input from a motion reference unit \(MRU\), page 241](#)
- [Setting up the input from a sound speed sensor, page 243](#)
- [Setting up depth output to an external system, page 245](#)
- [Exporting sensor data to a peripheral system, page 247](#)
- [Synchronizing the EK80 by means of a serial port, page 249](#)
- [Synchronizing the EK80 by means of the Auxiliary port, page 252](#)
- [Setting up the interface between the EK80 and the Simrad TD50, page 254](#)

### Installing navigation sensors and other sensors

For the EK80 to use and offer correct navigational information, one or more external sensors must be connected. Typical sensors are those providing navigational information (heading, speed or geographical position). To set up the communication parameters on the serial and LAN ports, use the **I/O Setup** page. To select which sensors to install, use the **Sensor Installation** page. The **Sensor Configuration** page allows you to define a datagram priority, so that the information from the "most reliable" sensor is used by the EK80. You can also define manual values in case a sensor is unserviceable, or not installed.

#### Prerequisites

The new sensor is physically connected to the EK80 using a serial or network cable.

#### Context

The **Sensor Installation** page allows your EK80 to communicate with external sensors and systems. However, in order to communicate with each sensor, you must first set up the relevant communication parameters. Once the communication has been established

and the sensor is connected, you must define the datagram priority and finalize the configuration.

#### Note

---

*Just making changes and selecting **OK** at the bottom of the page will not install anything. Select what to install, define the relevant parameters, and then select **Add**.*

---

#### Procedure

- 1 Open the **Setup** menu.
- 2 On the **Setup** menu, select **Install**.

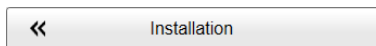

Observe that the **Installation** dialog box opens. This dialog box contains a number of pages selected from the menu on the left side.

- 3 Set up the interfaces to the navigation sensors.
  - a On the left side of the **Installation** dialog box, select **I/O Setup**.
  - b Set up the relevant serial or Ethernet (LAN) communication parameters.
  - c At the bottom of the page, select **Apply** to save your settings.
  - d On the left side of the **Installation** dialog box, select **Sensor Installation**.
  - e Select the type of sensor you want to interface, and define the relevant parameters.
  - f Select **Add** to save the new sensor interface you have defined.
  - g On the left side of the **Installation** dialog box, select **Sensor Configuration**.
  - h Define the priority of the datagrams, and set up relevant configuration parameters.
  - i At the bottom of the page, select **Apply** to save your settings.
- 4 Repeat for each sensor interface that you need to set up.
- 5 Continue your work in the **Installation** dialog box, or select **OK** to close it.

#### Related topics

[Interfacing peripheral equipment, page 228](#)

## Defining the serial and Ethernet (LAN) port parameters

For any sensor interface to work, the communication parameters must be set up correctly. The EK80 software automatically scans the Processor Unit to locate and identify the available communication ports. Once the software has established a list of valid interfaces, you can set up and control the communication parameters.

### Prerequisites

This procedure assumes that:

- You have a vacant interface port on your Processor Unit.
- You are familiar with NMEA and other relevant datagram formats.
- You know how to set up the parameters for serial and local area network (LAN) communication.
- The communication parameters required for the sensor interface are known.

### Context

The **I/O Setup** page provides two lists; one for serial ports and one for Ethernet (LAN) ports. Each list is supported with a set of functions to set up and monitor the communication ports. Select the port you want to work with and then select one of the buttons below the list.

#### Tip

---

*The **Sensors** page in the **BITE (Built-In Test Equipment)** dialog box provides an overview of all the communication lines and sensors in use. All relevant status information is provided. You open the **BITE** dialog box from the **Setup** menu.*

---

When you work in the **Installation** dialog box, you must always select **Apply** to save the changes made on a page. You must do this before you continue working on a different page.

### Procedure

- 1 Open the **Setup** menu.
- 2 On the **Setup** menu, select **Installation**.



- 3 Observe that the **Installation** dialog box opens. This dialog box contains a number of pages selected from the menu on the left side.
- 4 On the left side of the **Installation** dialog box, select **I/O Setup**.
- 5 Observe that the available serial and network interface ports on the Processor Unit are listed.
- 6 Set up the relevant serial or Ethernet (LAN) communication parameters.
  - a Select the interface port you wish to set up.



- b Select **Setup** below the list to open the **Serial Port Setup** or **LAN Port Setup** dialog box.
  - c Set up the relevant serial or Ethernet (LAN) communication parameters.  
The communication parameters defined for NMEA 0183 are:
    - **Baud rate:** 4800 bit/s
    - **Data bits:** 8
    - **Parity:** Even
    - **Stop bits:** 1Some instruments may provide other parameters and/or options. You must always check the relevant technical documentation supplied by the manufacturer.
  - d Select **OK** to save the selected settings and close the dialog box.
- 6 At the bottom of the page, select **Apply** to save your settings.
  - 7 Repeat for any other communication ports that you need to set up.
  - 8 Close the **Installation** dialog box.

### Related topics

[Interfacing peripheral equipment, page 228](#)

## Setting up the input from a navigation system (GPS)

For the EK80 to use and offer correct navigational information, one or more external sensors must be connected. Typical sensors are those providing navigational information (heading, speed or geographical position). To select which sensors to install, use the **Sensor Installation** page. Your current position is shown on the top bar if you have enabled this in the **Display Options** dialog box.

### Prerequisites

This procedure assumes that:

- You have a vacant interface port on your Processor Unit.
- You are familiar with NMEA and other relevant datagram formats.
- You know how to set up the parameters for serial and local area network (LAN) communication.
- The interface port is set up with the correct communication parameters.
- The EK80 system is turned on and operates normally.
- The new sensor is physically connected to the EK80 using a serial or network cable. The sensor is turned on and in normal operation.

Neither tools nor instruments are required.

## Context

The **Sensor Installation** page allows your EK80 to communicate with external sensors and systems. You must specify which communication port to use (LAN (Local Area Network) or serial port). You can type a custom name to identify the sensor import. In the list of valid datagram formats, select the format(s) to be accepted by the EK80. For each relevant sensor you must insert the offset values that define the its physical location relative to the vessel's coordinate system.

### Note

---

*Just making changes and selecting **OK** at the bottom of the page will not install anything. Select what to install, define the relevant parameters, and then select **Add**.*

---

## Procedure

- 1 Connect the navigation system to an available communication port on your Processor Unit.

This is described in the *Cable layout and interconnections* chapter. Observe the applicable requirements related to cabling. Make sure that the total length of the serial line cable does not exceed approximately 50 meters. If a longer cable is required, you may need to use buffer amplifiers.

If the Processor Unit is not fitted with a suitable serial line connector, use a USB-to-serial converter. Several types are commercially available. Note that most USB-to-serial converters will introduce some latency. They may also introduce be jitter in the communication. The amount of jitter depends on the quality of the converter.

- 2 Open the **Setup** menu.
- 3 On the **Setup** menu, select **Installation**.



Observe that the **Installation** dialog box opens. This dialog box contains a number of pages selected from the menu on the left side.

- 4 On the left side of the **Installation** dialog box, select **Sensor Installation**.
- 5 For **Type**, select the *GPS* sensor to import information from a global positioning system.
- 6 Select which port you want to import the sensor information on.
- 7 If you want to check the communication parameters, select **Inspect Port**.

### Note

---

*You cannot make any changes here. To change the communication parameters, use the **I/O Setup** page.*

---

- 8 If you want to check that the peripheral system is transmitting data to the EK80, select **Monitor**.

The **Port Monitor** dialog box provides one text box for incoming messages (**Rx Data**), and one for outgoing messages (**Tx Data**). Use these boxes and your knowledge of the data communication to investigate the datagrams. The **Port Monitor** dialog box is a tool for debugging purposes. It is neither required nor intended for normal operation of the EK80.

- 9 Type a custom name to identify the interface in other dialog boxes.
- 10 Select which datagram(s) you want to import from the sensor.
- 11 If relevant, specify a dedicated talker ID.
- 12 Provide the accurate physical location of the sensor (or its antenna) with reference to the vessel's coordinate system.

The position of certain sensors must be defined as an *offset* to the *Ship Origin* in the coordinate system to maximize performance. These offset values are all required to allow the EK80 to give you as accurate information as possible. The degree of accuracy offered by the EK80 is directly related to the accuracy of the information you enter on the **Sensor Installation** page.

- a Select the offset value on the X axis (fore-and-aft direction) from the *Ship Origin*. Adjust with a positive value for X if the sensor is located ahead of the ship origin.
- b Select the offset value on the Y axis (athwartship) from the *Ship Origin*. Adjust with a positive value for Y if the sensor is located on the starboard side of the ship origin.
- c Select the offset value on the Z axis (vertical) from the *Ship Origin*. Adjust with a positive value for Z if the sensor is located under the ship origin.
- 13 Select **Add** to save the new sensor interface you have defined.
- The sensor interface is added to the **Installed Sensors** list on the **Sensor Installation** page.
- 14 At the bottom of the dialog box, select **Apply** to save your settings.
- 15 Repeat for each sensor interface that you need to set up.
- 16 Continue your work in the **Installation** dialog box, or select **OK** to close it.

### **Further requirements**

On the left side of the **Installation** dialog box, select **Sensor Configuration**. Define the priority of the datagrams, and set up relevant configuration parameters.

### **Related topics**

[Interfacing peripheral equipment, page 228](#)

## Configuring the sensor interface

With several sensors connected to the EK80, many of them will provide the same datagrams. We cannot expect that the datagrams provide the same information. The **Sensor Configuration** page allows you to define a datagram priority, so that the information from the "most reliable" sensor is used by the EK80. You can also define manual values in case a sensor is unserviceable, or not installed.

### Prerequisites

This procedure assumes that:

- The new sensor is physically connected to the EK80 using a serial or network cable.
- The interface port is set up with the correct communication parameters.
- The navigation sensor is installed into the EK80 software. The relevant interface parameters and physical location properties are defined.

### Context

Any information in a datagram, for example the current depth, may be provided in different datagrams from several sensors. Due to a number of reasons (environmental conditions, installation, configuration, accuracy, etc.), the numerical values provided can be different from one sensor to another.

Several sensor are provided on the **Sensor Configuration** page, one for each type of information. Select the sensor you wish to configure in the **Sensor** list. For each type, you can define a priority sensor by rearranging the datagrams in a list. You can also define manual values in case a sensor is unserviceable, or not installed.

The EK80 can communicate with several different sensor types. Use the **Sensor Installation** page to define which external sensors your EK80 will import information from. You must also specify which datagram formats to use.

### Note

---

*When you work in the **Installation** dialog box, you must always select **Apply** to save the changes made on a page. You must do this before you continue working on a different page.*

---

### Procedure

- 1 Open the **Setup** menu.
- 2 On the **Setup** menu, select **Installation**.



Observe that the **Installation** dialog box opens. This dialog box contains a number of pages selected from the menu on the left side.

- 3 On the left side of the **Installation** dialog box, select **Sensor Configuration**.

Observe that the **Sensor Configuration** page opens.

- 4 Select the sensor you wish to configure in the **Sensor** list.
- 5 If you wish to use the built-in datagram priority, select **Auto**.
  - With **Auto enabled**, the priority list is used. Information is imported from the sensor at the top of the list. If the sensor fails to provide information for more than 20 seconds, data from the next sensor is used.
  - With **Auto disabled**, the priority list is not used. Information is imported from the sensor at the top of the list. All other sensors are ignored.
- 6 If you wish to control the datagram priority manually, *do not* select **Auto**.

To change the priority for a given datagram, select it, and change its location on the list using the arrow buttons.
- 7 If relevant, add a manual value for the sensor input.
- 8 At the bottom of the dialog box, select **Apply** to save your settings.
- 9 Repeat for each sensor interface that you need to set up.
- 10 Continue your work in the **Installation** dialog box, or select **OK** to close it.

### Related topics

[Interfacing peripheral equipment, page 228](#)

## Setting up a serial or LAN (Ethernet) port for annotation input

Several different annotation types may be added to the echograms or other views. They are displayed on the views if this annotation feature is enabled. You can add annotations manually, or import information as datagrams using a serial or LAN (Ethernet) communication port.

### Prerequisites

This procedure assumes that:

- You have a vacant interface port on your Processor Unit.
- You are familiar with NMEA and other relevant datagram formats.
- You know how to set up the parameters for serial and local area network (LAN) communication.
- The interface port is set up with the correct communication parameters.

### Context

The **Sensor Installation** page allows your EK80 to communicate with external sensors and systems. You must specify which communication port to use (LAN (Local Area Network) or serial port). You can type a custom name to identify the sensor import. In the list of valid datagram formats, select the format(s) to be accepted by the EK80.

Note

---

*Just making changes and selecting **OK** at the bottom of the page will not install anything. Select what to install, define the relevant parameters, and then select **Add**.*

---

**Procedure**

- 1 Connect the peripheral system providing the annotations to an available communication port on your Processor Unit.

This is described in the *Cable layout and interconnections* chapter. Observe the applicable requirements related to cabling. Make sure that the total length of the serial line cable does not exceed approximately 50 meters. If a longer cable is required, you may need to use buffer amplifiers.

If the Processor Unit is not fitted with a suitable serial line connector, use a USB-to-serial converter. Several types are commercially available. Note that most USB-to-serial converters will introduce some latency. They may also introduce jitter in the communication. The amount of jitter depends on the quality of the converter.

- 2 On the **Setup** menu, select **Installation**.

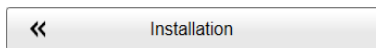

Observe that the **Installation** dialog box opens. This dialog box contains a number of pages selected from the menu on the left side.

- 3 On the left side of the **Installation** dialog box, select **Sensor Installation**.
- 4 Select *Annotations* to import information from the peripheral system.
- 5 Select the port you wish to use (serial or LAN).
- 6 If you want to check the communication parameters, select **Inspect Port**.

Note

---

*You cannot make any changes here. To change the communication parameters, use the **I/O Setup** page. The **I/O Setup** page is located in the **Installation and Output** dialog boxes.*

---

- 7 If you want to check that the peripheral system is transmitting data to the EK80, select **Monitor**.

The **Port Monitor** dialog box provides one text box for incoming messages (**Rx Data**), and one for outgoing messages (**Tx Data**). Use these boxes and your knowledge of the data communication to investigate the datagrams. The **Port Monitor** dialog box is a tool for debugging purposes. It is neither required nor intended for normal operation of the EK80.

- 8 Type a custom name to identify the interface in other dialog boxes.

- 9 Select which datagram(s) you want to import from the peripheral device.  
When you select sensor type Annotation, only one datagram can be selected.
- 10 Do not specify a dedicated Talker ID.
- 11 Select **Add** to save the new device interface you have defined.  
The device interface is added to the **Installed Sensors** list on the **Sensor Installation** page. It is not necessary to use the **Sensor Configuration** page to set up a priority list.
- 12 Select **Apply** and then **Close** to save all the parameters and close the **Installation** dialog box.

### Related topics

[Interfacing peripheral equipment, page 228](#)

## Connecting a catch monitoring system to a serial or LAN (Ethernet) port

A catch monitoring system can be connected to the EK80. The connection is made using a serial or LAN (Ethernet) port on the Processor Unit. For any sensor interface to work, the communication parameters must be set up correctly.

### Prerequisites

This procedure assumes that:

- You have a vacant interface port on your Processor Unit.
- You are familiar with NMEA and other relevant datagram formats.
- You know how to set up the parameters for serial and local area network (LAN) communication.
- The interface port is set up with the correct communication parameters.
- The EK80 system is turned on and operates normally.
- The new sensor is physically connected to the EK80 using a serial or network cable. The sensor is turned on and in normal operation.

Neither tools nor instruments are required.

### Context

The **Sensor Installation** page allows your EK80 to communicate with external sensors and systems. You must specify which communication port to use (LAN (Local Area Network) or serial port). You can type a custom name to identify the sensor import. In the list of valid datagram formats, select the format(s) to be accepted by the EK80. For each relevant sensor you must insert the offset values that define the its physical location relative to the vessel's coordinate system.

Note

---

*Just making changes and selecting **OK** at the bottom of the page will not install anything. Select what to install, define the relevant parameters, and then select **Add**.*

---

**Procedure**

- 1 Connect the peripheral catch monitoring system to an available communication port on your Processor Unit.

This is described in the *Cable layout and interconnections* chapter. Observe the applicable requirements related to cabling. Make sure that the total length of the serial line cable does not exceed approximately 50 meters. If a longer cable is required, you may need to use buffer amplifiers.

If the Processor Unit is not fitted with a suitable serial line connector, use a USB-to-serial converter. Several types are commercially available. Note that most USB-to-serial converters will introduce some latency. They may also introduce jitter in the communication. The amount of jitter depends on the quality of the converter.

- 2 Open the **Setup** menu.
- 3 On the **Setup** menu, select **Installation**.



Observe that the **Installation** dialog box opens. This dialog box contains a number of pages selected from the menu on the left side.

- 4 On the left side of the **Installation** dialog box, select **Sensor Installation**.
- 5 Select *PI50* to import information from a catch monitoring system.
- 6 Select the port you wish to use (serial or LAN).
- 7 If you want to check the communication parameters, select **Inspect Port**.

Note

---

*You cannot make any changes here. To change the communication parameters, use the **I/O Setup** page. The **I/O Setup** page is located in the **Installation and Output** dialog boxes.*

---

- 8 If you want to check that the peripheral system is transmitting data to the EK80, select **Monitor**.

The **Port Monitor** dialog box provides one text box for incoming messages (**Rx Data**), and one for outgoing messages (**Tx Data**). Use these boxes and your knowledge of the data communication to investigate the datagrams. The **Port Monitor** dialog box is a tool for debugging purposes. It is neither required nor intended for normal operation of the EK80.

- 9 Type a custom name to identify the interface in other dialog boxes.



- 10 Select which datagram(s) you want to import from the peripheral device.

When you select sensor type PI50, only one datagram can be selected; PI50 Datagrams. This is a group of datagrams that allows the EK80 to import information from catch monitoring systems.

- 11 Do not specify a dedicated Talker ID.
- 12 Select **Add** to save the new system interface you have defined.

The system interface is added to the **Installed Sensors** list on the **Sensor Installation** page. It is not necessary to use the **Sensor Configuration** page to set up a priority list.

- 13 Select **Apply** and then **Close** to save all the parameters and close the **Installation** dialog box.

### Related topics

[Interfacing peripheral equipment, page 228](#)

## Connecting a trawl system to a serial or LAN (Ethernet) port

A trawl system can be connected to the EK80. The connection is made using a serial or LAN (Ethernet) port on the Processor Unit. For any sensor interface to work, the communication parameters must be set up correctly.

### Prerequisites

This procedure assumes that:

- You have a vacant interface port on your Processor Unit.
- You are familiar with NMEA and other relevant datagram formats.
- You know how to set up the parameters for serial and local area network (LAN) communication.
- The interface port is set up with the correct communication parameters.
- The EK80 system is turned on and operates normally.
- The new sensor is physically connected to the EK80 using a serial or network cable. The sensor is turned on and in normal operation.

Neither tools nor instruments are required.

### Context

The **Sensor Installation** page allows your EK80 to communicate with external sensors and systems. You must specify which communication port to use (LAN (Local Area Network) or serial port). You can type a custom name to identify the sensor import. In the list of valid datagram formats, select the format(s) to be accepted by the EK80. For each relevant sensor you must insert the offset values that define its physical location relative to the vessel's coordinate system.

Note

---

*Just making changes and selecting **OK** at the bottom of the page will not install anything. Select what to install, define the relevant parameters, and then select **Add**.*

---

**Procedure**

- 1 Connect the peripheral trawl system to an available communication port on your Processor Unit.

This is described in the *Cable layout and interconnections* chapter. Observe the applicable requirements related to cabling. Make sure that the total length of the serial line cable does not exceed approximately 50 meters. If a longer cable is required, you may need to use buffer amplifiers.

If the Processor Unit is not fitted with a suitable serial line connector, use a USB-to-serial converter. Several types are commercially available. Note that most USB-to-serial converters will introduce some latency. They may also introduce jitter in the communication. The amount of jitter depends on the quality of the converter.

- 2 Open the **Setup** menu.
- 3 On the **Setup** menu, select **Installation**.

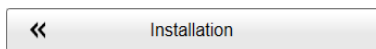

Observe that the **Installation** dialog box opens. This dialog box contains a number of pages selected from the menu on the left side.

- 4 On the left side of the **Installation** dialog box, select **Sensor Installation**.
- 5 Select *ITI-FS* to import information from a trawl system.
- 6 Select the port you wish to use (serial or LAN).
- 7 If you want to check the communication parameters, select **Inspect Port**.

Note

---

*You cannot make any changes here. To change the communication parameters, use the **I/O Setup** page. The **I/O Setup** page is located in the **Installation and Output** dialog boxes.*

---

- 8 If you want to check that the peripheral system is transmitting data to the EK80, select **Monitor**.

The **Port Monitor** dialog box provides one text box for incoming messages (**Rx Data**), and one for outgoing messages (**Tx Data**). Use these boxes and your knowledge of the data communication to investigate the datagrams. The **Port Monitor** dialog box is a tool for debugging purposes. It is neither required nor intended for normal operation of the EK80.

- 9 Type a custom name to identify the interface in other dialog boxes.

- 10 Select which datagram(s) you want to import from the peripheral device.  
When you select sensor type ITI-FS, only one datagram can be selected; ITI-FS Datagrams. This is a group of datagrams that allows the EK80 to import information from trawl systems.
- 11 Do not specify a dedicated Talker ID.
- 12 Select **Add** to save the new system interface you have defined.  
The system interface is added to the **Installed Sensors** list on the **Sensor Installation** page. It is not necessary to use the **Sensor Configuration** page to set up a priority list.
- 13 Select **Apply** and then **Close** to save all the parameters and close the **Installation** dialog box.

### Related topics

[Interfacing peripheral equipment, page 228](#)

## Setting up the input from a motion reference unit (MRU)

The information from a motion reference unit (MRU) (normally heave, roll and pitch information) is imported into the EK80 to increase the accuracy of the echo data.

### Prerequisites

This procedure assumes that:

- You have a vacant interface port on your Processor Unit.
- You are familiar with NMEA and other relevant datagram formats.
- You know how to set up the parameters for serial and local area network (LAN) communication.
- The interface port is set up with the correct communication parameters.
- The EK80 system is turned on and operates normally.
- The new sensor is physically connected to the EK80 using a serial or network cable. The sensor is turned on and in normal operation.

Neither tools nor instruments are required.

### Context

A motion reference unit (MRU) measures the vessel's pitch and roll movements in the sea. The information provided by the motion sensor is used by the EK80 to stabilize the beams and the echo presentation.

Note

---

*ADCP operations cannot take place without input from a motion reference unit (MRU). The input must be provided on the KM Binary datagram format. KM Binary is a proprietary datagram format created by Kongsberg Maritime for general use. This format has very high resolution on timing and sensor parameters.*

---

**Procedure**

- 1 Connect the motion sensor system to an available communication port on your Processor Unit.

This is described in the *Cable layout and interconnections* chapter. Observe the applicable requirements related to cabling. Make sure that the total length of the serial line cable does not exceed approximately 50 meters. If a longer cable is required, you may need to use buffer amplifiers.

If the Processor Unit is not fitted with a suitable serial line connector, use a USB-to-serial converter. Several types are commercially available. Note that most USB-to-serial converters will introduce some latency. They may also introduce jitter in the communication. The amount of jitter depends on the quality of the converter.

- 2 Open the **Setup** menu.
- 3 On the **Setup** menu, select **Installation**.

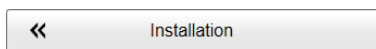

Observe that the **Installation** dialog box opens. This dialog box contains a number of pages selected from the menu on the left side.

- 4 On the left side of the **Installation** dialog box, select **Sensor Installation**.
- 5 Select the motion reference format you want to use.
- 6 Select the port you wish to use (serial or LAN).
- 7 If you want to check the communication parameters, select **Inspect Port**.

Note

---

*You cannot make any changes here. To change the communication parameters, use the **I/O Setup** page. The **I/O Setup** page is located in the **Installation and Output** dialog boxes.*

---

- 8 If you want to check that the peripheral system is transmitting data to the EK80, select **Monitor**.

The **Port Monitor** dialog box provides one text box for incoming messages (**Rx Data**), and one for outgoing messages (**Tx Data**). Use these boxes and your knowledge of the data communication to investigate the datagrams. The **Port**

**Monitor** dialog box is a tool for debugging purposes. It is neither required nor intended for normal operation of the EK80.

- 9 Type a custom name to identify the interface in other dialog boxes.
- 10 Select which datagram(s) you want to import from the sensor.
- 11 If relevant, specify a dedicated talker ID.
- 12 Provide the accurate physical location of the sensor (or its antenna) with reference to the vessel's coordinate system.

The position of certain sensors must be defined as an *offset* to the *Ship Origin* in the coordinate system to maximize performance. These offset values are all required to allow the EK80 to give you as accurate information as possible. The degree of accuracy offered by the EK80 is directly related to the accuracy of the information you enter on the **Sensor Installation** page.

- a Select the offset value on the X axis (fore-and-aft direction) from the *Ship Origin*. Adjust with a positive value for X if the sensor is located ahead of the ship origin.
  - b Select the offset value on the Y axis (athwartship) from the *Ship Origin*. Adjust with a positive value for Y if the sensor is located on the starboard side of the ship origin.
  - c Select the offset value on the Z axis (vertical) from the *Ship Origin*. Adjust with a positive value for Z if the sensor is located under the ship origin.
- 13 Select **Add** to save the new sensor interface you have defined.  
The sensor interface is added to the **Installed Sensors** list on the **Sensor Installation** page.
  - 14 Select **Apply** and then **Close** to save all the parameters and close the **Installation** dialog box.

### Related topics

[Interfacing peripheral equipment, page 228](#)

## Setting up the input from a sound speed sensor

If you have a sound speed sensor located close to the transducer face, you can import the information from this sensor. This will result in more accurate EK80 data.

### Prerequisites

This procedure assumes that:

- You have a vacant interface port on your Processor Unit.
- You are familiar with NMEA and other relevant datagram formats.
- You know how to set up the parameters for serial and local area network (LAN) communication.

- The interface port is set up with the correct communication parameters.
- The EK80 system is turned on and operates normally.
- The new sensor is physically connected to the EK80 using a serial or network cable. The sensor is turned on and in normal operation.

Neither tools nor instruments are required.

### Context

The **Sensor Installation** page allows your EK80 to communicate with external sensors and systems. You must specify which communication port to use (LAN (Local Area Network) or serial port). You can type a custom name to identify the sensor import. In the list of valid datagram formats, select the format(s) to be accepted by the EK80.

### Note

---

*Just making changes and selecting **OK** at the bottom of the page will not install anything. Select what to install, define the relevant parameters, and then select **Add**.*

---

Communication with the sound speed sensor is based on proprietary datagrams.

### Procedure

- 1 Connect the sound speed sensor to an available serial communication port on your Processor Unit.

This is described in the *Cable layout and interconnections* chapter. Observe the applicable requirements related to cabling. Make sure that the total length of the serial line cable does not exceed approximately 50 meters. If a longer cable is required, you may need to use buffer amplifiers.

If the Processor Unit is not fitted with a suitable serial line connector, use a USB-to-serial converter. Several types are commercially available. Note that most USB-to-serial converters will introduce some latency. They may also introduce jitter in the communication. The amount of jitter depends on the quality of the converter.

- 2 Open the **Setup** menu.
- 3 On the **Setup** menu, select **Installation**.

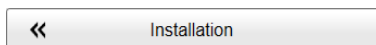

Observe that the **Installation** dialog box opens. This dialog box contains a number of pages selected from the menu on the left side.

- 4 On the left side of the **Installation** dialog box, select **Sensor Installation**.
- 5 For **Type**, select *Sound Speed* to import information from a sound speed sensor.
- 6 Select which port you want to import the sensor information on.

- 7 If you want to check the communication parameters, select **Inspect Port**.

**Note**

---

*You cannot make any changes here. To change the communication parameters, use the **I/O Setup** page.*

---

- 8 If you want to check that the peripheral system is transmitting data to the EK80, select **Monitor**.

The **Port Monitor** dialog box provides one text box for incoming messages (**Rx Data**), and one for outgoing messages (**Tx Data**). Use these boxes and your knowledge of the data communication to investigate the datagrams. The **Port Monitor** dialog box is a tool for debugging purposes. It is neither required nor intended for normal operation of the EK80.

- 9 Type a custom name to identify the interface in other dialog boxes.  
10 Select which datagram(s) you want to import from the sensor.  
11 If relevant, specify a dedicated talker ID.  
12 Select **Add** to save the new sensor interface you have defined.

The sensor interface is added to the **Installed Sensors** list on the **Sensor Installation** page.

- 13 Select **Apply** and then **Close** to save all the parameters and close the **Installation** dialog box.

### **Related topics**

[Interfacing peripheral equipment, page 228](#)

## Setting up depth output to an external system

The EK80 can export depth information on a dedicated communication port (serial or Ethernet) The **Depth Output** page is used to set up the output parameters.

### **Prerequisites**

This procedure assumes that:

- You have a vacant interface port on your Processor Unit.
- You are familiar with NMEA and other relevant datagram formats.
- You know how to set up the parameters for serial and local area network (LAN) communication.
- The interface port is set up with the correct communication parameters.
- The EK80 system is turned on and operates normally.

Neither tools nor instruments are required.

## Context

The EK80 can export the depth information on several datagram formats. You can export several depth formats simultaneously, as each of them is handled independently.

## Procedure

- 1 Connect the peripheral system to an available communication port on your Processor Unit.

This is described in the *Cable layout and interconnections* chapter. Observe the applicable requirements related to cabling. Make sure that the total length of the serial line cable does not exceed approximately 50 meters. If a longer cable is required, you may need to use buffer amplifiers.

If the Processor Unit is not fitted with a suitable serial line connector, use a USB-to-serial converter. Several types are commercially available. Note that most USB-to-serial converters will introduce some latency. They may also introduce jitter in the communication. The amount of jitter depends on the quality of the converter.

- 2 Open the **Operation** menu.
- 3 Select **Output**.

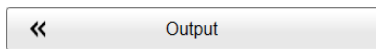

Observe that the **Output** dialog box opens. This dialog box contains a number of pages selected from the menu on the left side.

- 4 On the left side of the **Outputs** dialog box, select **I/O Setup**.  
Observe that the **I/O Setup** page opens.
- 5 Observe that the available serial and network interface ports on the Processor Unit are listed.
- 6 Set up the relevant serial or Ethernet (LAN) communication parameters.
  - a On the **I/O Setup** page, select the port you wish to set up.
  - b Select **Setup** below the list to open the **Serial Port Setup** or **LAN Port Setup** dialog box.
  - c Set up the relevant communication parameters.
- 7 On the left side of the **Output** dialog box, select **Depth Output**.  
Observe that the **Depth Output** page opens.
- 8 Select **Processed Data to Output** to open the page.
  - a Select which depth datagram to export.
  - b Select the communication port you want to use.



- c Choose which channel to use as source for the depth information.  
"Best practice" is to use the lowest frequency. In this context, the phrase *channel* is used as a common term to identify the combination of transceiver, transducer and operating frequency.
  - d Select **Add** to start export of the chosen data format.  
Once an output type has been defined, it is listed in the **Installed Outputs** box on the left side of the page.
- 9 If you want to check the communication parameters, select **Inspect Port**.
- Note** \_\_\_\_\_  
*You cannot make any changes here. To change the communication parameters, use the **I/O Setup** page. The **I/O Setup** page is located in the **Installation and Output** dialog boxes.*
- 
- 10 If you want to check the data flow on the selected port, select **Monitor**.  
Make sure that there is data traffic on the output port (shown in the **Tx Data** box).  
The **Port Monitor** dialog box provides one text box for incoming messages (**Rx Data**), and one for outgoing messages (**Tx Data**). Use these boxes and your knowledge of the data communication to investigate the datagrams. The **Port Monitor** dialog box is a tool for debugging purposes. It is neither required nor intended for normal operation of the EK80.
- 11 Select **Apply** and then **Close** to save all the parameters and close the **Output** dialog box.

### Related topics

[Interfacing peripheral equipment, page 228](#)

## Exporting sensor data to a peripheral system

The information provided to the EK80 from various sensors can also be useful for other systems on board. The EK80 allows you to export the same sensor data that was originally imported. This can "reuse" the same information on other systems. The **Relay Output** page is used to set up and control this export functionality.

### Prerequisites

This procedure assumes that:

- You have a vacant interface port on your Processor Unit.
- You are familiar with NMEA and other relevant datagram formats.
- You know how to set up the parameters for serial and local area network (LAN) communication.
- The interface port is set up with the correct communication parameters.

- The EK80 system is turned on and operates normally.

Neither tools nor instruments are required.

### Context

The information imported to the EK80 from various sensors can also be useful for other systems on board your vessel. The EK80 allows you to "re-export" this sensor information. When activated, the selected sensor information is sent out on the chosen communication port (serial or LAN) on the Processor Unit.

The following sensor data can be exported:

- Navigation
- Motion sensor

### Procedure

- 1 Connect the peripheral system to an available communication port on your Processor Unit.

This is described in the *Cable layout and interconnections* chapter. Observe the applicable requirements related to cabling. Make sure that the total length of the serial line cable does not exceed approximately 50 meters. If a longer cable is required, you may need to use buffer amplifiers.

If the Processor Unit is not fitted with a suitable serial line connector, use a USB-to-serial converter. Several types are commercially available. Note that most USB-to-serial converters will introduce some latency. They may also introduce jitter in the communication. The amount of jitter depends on the quality of the converter.

- 2 Open the **Operation** menu.
- 3 Select **Output**.

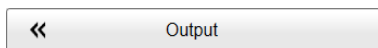

Observe that the **Output** dialog box opens. This dialog box contains a number of pages selected from the menu on the left side.

- 4 On the left side of the dialog box, select **I/O Setup**.
- 5 Observe that the available serial and network interface ports on the Processor Unit are listed.
- 6 Set up the relevant serial or Ethernet (LAN) communication parameters.
  - a On the **I/O Setup** page, select the port you wish to set up.

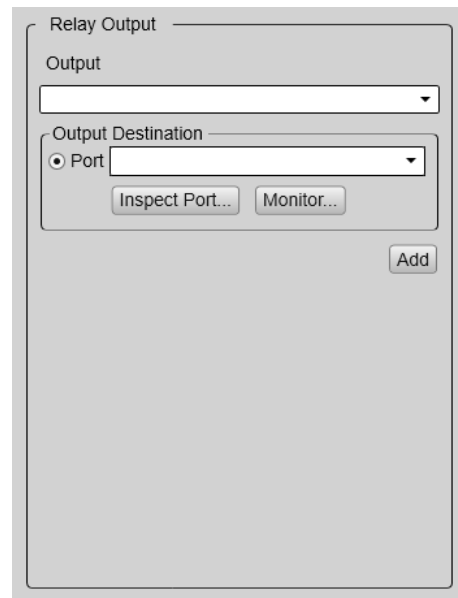

- b Select **Setup** below the list to open the **Serial Port Setup** or **LAN Port Setup** dialog box.
  - c Set up the relevant communication parameters.
  - d Select **Apply** to save your choices.
- 7 On the left side of the **Output** dialog box, select **Relay Output**.
- 8 On the **Relay Output** page, set up the data export parameters.
  - a Select which information to export.
  - b Select the communication port you want to use.
  - c Select **Add** to start export of the chosen data format.
- 9 If you want to check the communication parameters, select **Inspect Port**.

---

**Note**

*You cannot make any changes here. To change the communication parameters, use the **I/O Setup** page. The **I/O Setup** page is located in the **Installation and Output** dialog boxes.*

---

- 10 If you want to check the data flow on the selected port, select **Monitor**.

In order to see this data traffic, your EK80 must be active and transmitting information to the peripheral system.

The **Port Monitor** dialog box provides one text box for incoming messages (**Rx Data**), and one for outgoing messages (**Tx Data**). Use these boxes and your knowledge of the data communication to investigate the datagrams. The **Port Monitor** dialog box is a tool for debugging purposes. It is neither required nor intended for normal operation of the EK80.
- 11 Select **Apply** and then **Close** to save all the parameters and close the **Output** dialog box.

**Related topics**

[Interfacing peripheral equipment, page 228](#)

## Synchronizing the EK80 by means of a serial port

If you want to use the EK80 as a master or slave in a synchronized system, you must set it up for such operation. To do this, you must select which communication port to use for the synchronization interface, and you must select the requested synchronization mode.

**Prerequisites**

You have an RS2-232 interface port on your Processor Unit that allows you to use the CTS/RTS connections.

For "slave" operation, a remote system (for example *K-Sync*) must be available to provide trigger pulses. For "master" operation, a remote hydroacoustic system (sonar, echo sounder) is connected. This remote system must be set up in "slave" mode.

You must be equipped with a standard set of tools. This tool set must comprise the normal tools for electronic and electromechanical tasks. This includes different screwdriver types, pliers, spanners, a cable stripper, a soldering iron, etc. Each tool must be provided in various sizes. We recommend that all tools are demagnetized to protect your equipment.

### Context

Whenever more than one hydroacoustic system is installed on a vessel, interference may occur. To avoid interference, you have these options:

- The systems are all connected to a common synchronization system.
- One of the acoustic systems is set up as "master", and controls the transmissions on the other systems.

The EK80 offers functionality for remote transmit synchronization. It can be set up to operate in either *Master* or *Slave* mode.

### Tip

---

*The Wide Band Transceiver (WBT) offers an AUXILIARY port that can be used for synchronisation purposes. This synchronization method may be more stable than the traditional CTS/RTS connection to a serial port.*

*The Synchronization Delay functionality is unavailable if you use the AUXILIARY port on your Wide Band Transceiver (WBT) to synchronize the EK80.*

---

When you work in the **Installation** dialog box, you must always select **Apply** to save the changes made on a page. You must do this before you continue working on a different page.

### Procedure

- 1 Connect the synchronization cable from the remote system to an available communication port on your Processor Unit.

This is described in the *Cable layout and interconnections* chapter. Observe the applicable requirements related to cabling. Make sure that the total length of the serial line cable does not exceed approximately 50 meters. If a longer cable is required, you may need to use buffer amplifiers.

If the Processor Unit is not fitted with a suitable serial line connector, use a USB-to-serial converter. Several types are commercially available. Note that most USB-to-serial converters will introduce some latency. They may also introduce jitter in the communication. The amount of jitter depends on the quality of the converter.

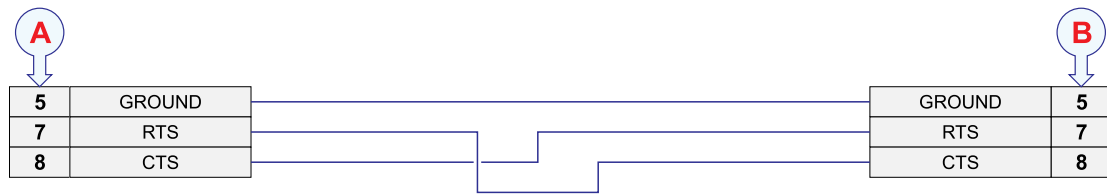

**A** *Local connection on the Processor Unit*

**B** *Connection on remote device*

- 2 Turn on the EK80, and set it to normal use.
- 3 Open the **Setup** menu.
- 4 On the **Setup** menu, select **Installation**.

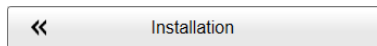

Observe that the **Installation** dialog box opens. This dialog box contains a number of pages selected from the menu on the left side.

- 5 On the left side of the **Installation** dialog box, select **Synchronization**.
- 6 Select **Synchronization Mode**.

- *Stand-alone*

Synchronization is turned off. This synchronization mode is used if the EK80 is working by itself and with no synchronization required. This is the default setting. The EK80 operates using its internal ping interval parameters, independent of any trigger signals arriving at the synchronization port.

The **Synchronization Delay** setting is not applicable when synchronization is switched off.

- *Master*

*Master* mode is used if the EK80 is going to act as the controlling unit in a synchronized system. The peripheral hydroacoustic system(s) are only permitted to transmit when enabled by the EK80. When *Master* mode is selected, the EK80 will run using its internal ping interval parameters and send trigger signals to the peripheral system(s).

This mode is unavailable if you set **Synchronization Port** to *Transceiver Auxiliary Port*.

- *Slave*

*Slave* mode is used if the EK80 is going to transmit only when permitted by a peripheral system. When *Slave* mode is selected, the EK80 does not transmit ("ping") unless an external trigger appears on the chosen synchronization port. The peripheral system may be any other hydroacoustic product (for example an echo sounder or sonar), or even a dedicated synchronization system.

- 7 Select **Synchronization Delay**.

This delay parameter is used differently depending on the chosen synchronization mode.

- *Stand-alone*

The **Synchronization Delay** setting is not applicable when synchronization is switched off.

- *Master*

In *Master* mode, the EK80 waits for the delay time after the external trigger signal has been sent to the slaves before transmitting the ping. This is often referred to as a *pre-trigger*.

**Note**

---

*This delay will only work when the synchronization is set up using a serial port.*

---

- *Slave*

In *Slave* mode, the EK80 waits for the delay time after the external trigger signal has arrived before transmitting the ping. This is often referred to as a *post-trigger*.

8 From the list of ports available, select **Synchronization Port**.

This is the interface port currently used to transmit or receive synchronization signals. It must be an RS-232 serial port. Since the synchronization function only uses the *Request To Send (RTS)* and *Clear To Send (CTS)* signals on a serial port, you can use a port that is already used for other purposes. For the same reason, you do not need to define any baud rate.

9 At the bottom of the page, select **Apply** to save your settings.

10 Continue your work in the **Installation** dialog box, or select **OK** to close it.

### Related topics

[Setting up the EK80 in a synchronized system, page 126](#)

[Cable layout and interconnections, page 85](#)

[Interfacing peripheral equipment, page 228](#)

## Synchronizing the EK80 by means of the Auxiliary port

The Wide Band Transceiver (WBT) offers an **AUXILIARY** port that can be used for synchronisation purposes. This synchronization method may be more stable than the traditional CTS/RTS connection to a serial port.

### Prerequisites

Unless the physical connections already have been made with a suitable cable, you need the following items:

- Cable
- Plug

You must be equipped with a standard set of tools. This tool set must comprise the normal tools for cable installation tasks. This includes different screwdriver types, pliers, spanners, a cable stripper, a soldering iron, etc. Each tool must be provided in various sizes. We recommend that all tools are demagnetized to protect your equipment. Depending on the tasks at hand, additional tools may be required.

## Context

The **AUXILIARY** socket on the Wide Band Transceiver (WBT) can be used to interface an external synchronization system.

The socket fits a Conxall 7-pin Mini-Con-X<sup>®</sup> shielded plug. The connections are made on pins 2, 3 and 5. The plug can be ordered from the manufacturer or purchased from Kongsberg Maritime. Use part number 387563.

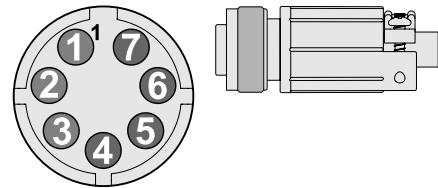

- **Manufacturer:** Switchcraft Conxall
- **Manufacturer's website:** <http://www.conxall.com>

Pin number	1	2	3	4
<b>Signal</b>	Future use	Synchronization Output	Synchronization Input	Future use
Pin number	5	6	7	
<b>Signal</b>	Digital ground	Not used	Not used	

The parameters on the **Synchronization** page allow you to choose which communication port to use for the physical connection to the external system, and which synchronization mode to use. The **Synchronization** page is located in the **Installation** dialog box on the **Setup** menu.

## Note

*If you use more than one Wide Band Transceiver (WBT) in your EK80 system, all synchronization input signals to the **AUXILIARY** ports must be provided by the same source. Individual synchronization of a single Wide Band Transceiver (WBT) is not supported.*

*If you use more than one computer in your EK80 system, the synchronization inputs to the **AUXILIARY** ports can not be used. This functionality is not supported.*

*The **Synchronization Delay** functionality is unavailable if you use the **AUXILIARY** port on your Wide Band Transceiver (WBT) to synchronize the EK80.*

## Procedure

- 1 Connect the dedicated cable from the Wide Band Transceiver (WBT) to the external synchronisation system.

This is described in the *Cable layout and interconnections* chapter. Observe the applicable requirements related to cabling.

- 2 Turn on the EK80, and set it to normal use.
- 3 Open the **Setup** menu.
- 4 On the **Setup** menu, select **Installation**.

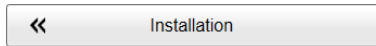

Observe that the **Installation** dialog box opens. This dialog box contains a number of pages selected from the menu on the left side.

- 5 On the left side of the **Installation** dialog box, select **Synchronization**.
- 6 From the list of ports available, select **Transceiver Auxiliary Port**.
- 7 Observe that when **Transceiver Auxiliary Port** is selected, only *Slave* synchronization mode is permitted.

*Slave* mode is used if the EK80 is going to transmit only when permitted by a peripheral system. When *Slave* mode is selected, the EK80 does not transmit ("ping") unless an external trigger appears on the chosen synchronization port. The peripheral system may be any other hydroacoustic product (for example an echo sounder or sonar), or even a dedicated synchronization system.

- 8 At the bottom of the page, select **Apply** to save your settings.
- 9 Continue your work in the **Installation** dialog box, or select **OK** to close it.

### Related topics

[Setting up the EK80 in a synchronized system, page 126](#)

[Cable layout and interconnections, page 85](#)

[Interfacing peripheral equipment, page 228](#)

## Setting up the interface between the EK80 and the Simrad TD50

The EK80 can be set up to communicate with the Simrad TD50 3D Visualization Software. In this context, the EK80 is regarded as the "source system". The interface between the EK80 and the TD50 computer uses a high-speed Ethernet connection. The relevant IP addresses must be defined on both computers.

### Prerequisites

It is assumed that you are familiar with the Windows® operating systems, computer technology, and interface principles.

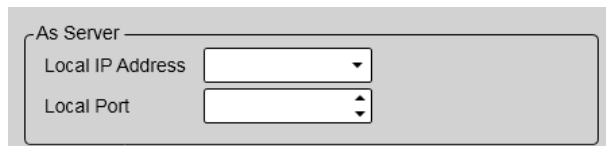

The Ethernet adapter in the EK80 Processor Unit is set up with the correct IP addresses.



## Context

All the steps in this procedure are done in the EK80 user interface.

## Procedure

- 1 Open the **Setup** menu.
- 2 On the **Setup** menu, select **Installation**.
- 3 On the left side of the **Installation** dialog box, select **Remote Control** and then **As Server** to open the page.

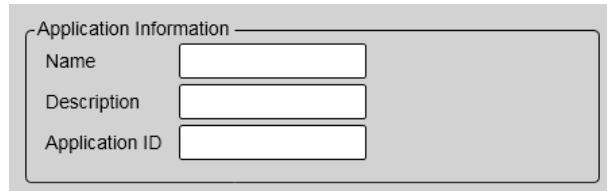

The screenshot shows a dialog box titled "Application Information". It contains three text input fields stacked vertically, labeled "Name", "Description", and "Application ID". The dialog box has a light gray background and a thin border.

- a Select the **Local IP Address**.  
This is the Internet Protocol (IP) address of the Ethernet interface adapter located in your Processor Unit.
- b Keep the present value in **Local Port**.
- 4 Select **Remote Control**, then **Application Information** to open the page.
- 5 Provide relevant application information.
- 6 At the bottom of the page, select **Apply** to save your settings.
- 7 Select **OK** to close the dialog box.

## Related topics

[Interfacing peripheral equipment, page 228](#)

## Test procedures

### Topics

[Functional test of the EK80 Wide band scientific echo sounder, page 257](#)

[Measuring noise in passive operating mode, page 259](#)

[Reading the transceiver hardware and software versions, page 261](#)

[Verifying the communication with the course gyro, page 263](#)

[Verifying the communication with a navigation system \(GPS\), page 265](#)

[Verifying the communication with speed log, page 267](#)

[Verifying the communication with the motion reference unit \(MRU\), page 269](#)

[Verifying the communication with a synchronization system, page 271](#)

[Making a noise/speed curve to determine vessel noise, page 273](#)

## Functional test of the EK80 Wide band scientific echo sounder

A brief functional test is used to verify that the EK80 is operational.

### Prerequisites

The EK80 hardware units are installed as specified in this manual.

- The EK80 is turned off.
- All relevant channels (transceiver/transducer combinations) are installed in the user interface.
- All relevant external sensors are connected to the EK80. The sensors are turned on and operate normally.
- The vessel is berthed or at sea.

Neither tools nor instruments are required.

### Caution

---

*You must never set the EK80 to "ping" unless the transducer is submerged in water. The transducer may be damaged if it transmits in open air.*

---

### Procedure

- 1 Make sure that the EK80 units have been set up to operate with the supply voltage you have available.
- 2 Make sure that the transducer cables are not installed close to power cables.
- 3 Turn all EK80 system units on.
- 4 Make sure that the power LED on the Wide Band Transceiver (WBT) is lit.
- 5 On the Processor Unit desktop, double-click the EK80 icon to start the program.
- 6 Make sure that the latest software version is installed.

Every EK80 software release is uniquely identified. The **About** dialog box identifies the current EK80 software version. If you wish to find the latest software version for the EK80, check our website.

- <https://www.kongsberg.com/ek80>
  - a Open the **Setup** menu.
  - b Select **About** to open the dialog box.
  - c Find the information that you need.
  - d Select **Close** to close the dialog box.

Note

---

*Certain software upgrades for the EK80 also include an upgrade for the transceiver. To ensure maximum operational performance, you must upgrade all transceivers with the software/firmware provided with the EK80 installation files.*

---

- 7 Make sure that each transducer has been installed with all settings defined.
  - a On the **Setup** menu, select **Installation**.
  - b On the left side of the **Installation** dialog box, select **Transducer Installation**.
  - c On the **Installed Transducers** list, select one of the transducers.
  - d Make sure that the transducer has been installed with all settings defined.
  - e Make sure that the offset values are correct.
  - f Repeat for each transducer that is installed.
- 8 Make sure that each transceiver channel is operational.

In this context, the phrase *channel* is used as a common term to identify the combination of transceiver, transducer and operating frequency.

  - a On the left side of the **Installation** dialog box, select **Transceiver**.
  - b Make sure that all applicable transceivers and transducers are connected and operational.
  - c For each transceiver, this is indicated by the green label with text "Installed".
- 9 Open the **Operation** menu.
- 10 Set **Operation** to *Normal*.
- 11 Set **Range** to *Auto*.
- 12 Make sure that you can see the seafloor in each echogram.

Locating the bottom (seafloor) is important for the EK80. The EK80 needs this *bottom lock* to locate the correct depth, and to stay on it during the operation, even if the depth changes continuously. Occasionally, difficult environmental, water or bottom conditions may inhibit a *bottom lock*.

If the EK80 is unable to find the bottom (seafloor) you may need to change the bottom detection parameters.

  - a Open the **Active** menu.
  - b Select **Bottom Detection**.
  - c Set **Minimum Depth** and **Maximum Depth** to values fit for the depth at your current location.
  - d Select **Close** to close the dialog box.
- 13 For each channel:
  - a Start raw data recording.

- b Allow the data recording to run approximately five minutes.
  - c Stop raw data recording.
  - d Use a file manager, and verify that the recorded file(s) have been saved on the chosen disk.
  - e Verify that the playback is operational.
- 14 Select **Help** on the top bar.
- a Make sure that the online help opens on its start page.
  - b Close the online help.



## Result

Requirements	Results
The latest software version is installed.	
Each transducer is installed with the correct parameters.	
Each transceiver channel is operational.	
The EK80 detects and displays a bottom echo in each echogram.	
Date and signature:	

## Related topics

[Test procedures, page 256](#)

## Measuring noise in passive operating mode

Low noise is a key factor for high quality and reliable measurements. The performance of the EK80 will always be limited by different noise sources. The noise is measured while the EK80 operates in *Passive* mode with the transmit pulses disabled.

## Prerequisites

The EK80 hardware units are installed as specified in this manual.

- The EK80 system is turned on and operates normally.

### *Caution*

*You must never set the EK80 to "ping" unless the transducer is submerged in water. The transducer may be damaged if it transmits in open air.*

- All the relevant transceivers have been set up, and they are operational with their respective transducers.
- All relevant channels (transceiver/transducer combinations) are installed in the user interface.
- All relevant external sensors are connected to the EK80. The sensors are turned on and operate normally.

- The vessel is berthed or at sea.

In order to do this test, the ship must be "silent".

- The water must be as deep as possible. Recommended minimum depth is 100 metres.
- There must be no other vessels in the vicinity.
- The vessel must lie still in the water.
- As much machinery as possible must be turned off. It is particularly important to turn off electrical motors, as well as cooling systems and hydraulic pumps that may cause electric noise.
- To prevent interference, all other hydroacoustic instruments must be turned off.

#### Note

---

*This test must be considered as indicative. With the vessel in port, the environmental conditions are not satisfactory. In the shallow waters of the port, noise from other vessels, dockyard workers or machinery will cause unreliable test results. If you do this tests in a busy harbour, or with noise sources present, the sensitive receivers will detect all the noise in the nearby waters.*

---

Neither tools nor instruments are required.

### Context

It is essential that the noise signature is as low as possible. Your EK80 must be set to *Passive* mode.

### Procedure

- 1 To select *Passive* mode, use the **Normal Operation** dialog box.
  - a Open the **Operation** menu.
  - b Select **Normal Operation**.
  - c For the relevant transceiver channel, set **Mode** to *Passive*.
  - d Set **Pulse Duration** to 1.024 ms.
  - e Select **OK** to save the selected setting and close the dialog box.

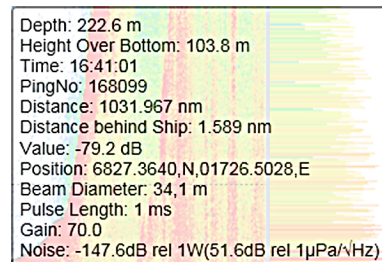

#### Note

---

*If you set **Mode** to *Passive*, your EK80 will no longer provide any information in the echogram(s).*

---

- 2 Enable the **Noise** tooltip.
  - a Open the **Display** menu.
  - b Select **Display Options** to open the dialog box.

- c Select **Tooltip** to open the page.
  - d Select **Noise** to enable the tooltip.
  - e Select **OK** to save the selected setting and close the dialog box.
- 3 For each channel:
- a Place the cursor in the approximate centre of the echogram, and observe the tooltip information.
  - b Read the noise value.
  - c Fill in the result table.

### Result

Frequency	Noise level	Frequency	Noise level
18 kHz		120 kHz	
33 kHz		200 kHz	
70 kHz		333 kHz	

Requirements	Results
The noise levels are recorded.	
Date and signature:	

### Related topics

[Test procedures, page 256](#)

## Reading the transceiver hardware and software versions

The firmware and software versions in use by each transceiver are required for a unique identification of the EK80 system at the time of the test. The **Transceiver Installation** page in the EK80 user interface contains all relevant information related to the hardware and software versions in the transceiver.

### Prerequisites

The EK80 hardware units are installed as specified in this manual.

- The EK80 system is turned on and operates normally.

*Caution*

---

*You must never set the EK80 to "ping" unless the transducer is submerged in water. The transducer may be damaged if it transmits in open air.*

---

- All the relevant transceivers have been set up, and they are operational with their respective transducers.
- All relevant channels (transceiver/transducer combinations) are installed in the user interface.
- All relevant external sensors are connected to the EK80. The sensors are turned on and operate normally.
- The vessel is berthed or at sea.

**Procedure**

- 1 Open the **Setup** menu.
- 2 On the **Setup** menu, select **Installation**.

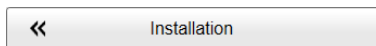

Observe that the **Installation** dialog box opens. This dialog box contains a number of pages selected from the menu on the left side.

- 3 On the left side, select **Transceiver**.
- 4 Make sure that all applicable transceivers and transducers are connected and operational.  
For each transceiver, this is indicated by the green label with text "Installed".
- 5 Repeat this cycle for each Wide Band Transceiver (WBT) in use.
  - a Click on the transceiver to select it.
  - b In the transceiver list, read the name of the transducer in use.
  - c In the *Transceiver Information* field, read the following information:
    - Identity
    - TX Firmware version
    - RX Firmware version
    - Software version
- 6 Fill in the result table.
- 7 Close the **Installation** dialog box.



## Result

Fill in the software and firmware versions for each Transceiver Unit.			
Serial number	TX Firmware version	RX Firmware version	Software version

## Related topics

[Test procedures, page 256](#)

## Verifying the communication with the course gyro

Without the input from a course gyro, the EK80 will not be able to present correct navigational information. The current heading is shown on the top bar if you have enabled this in the **Display Options** dialog box. The communication with the sensor is tested.

## Prerequisites

The EK80 hardware units are installed as specified in this manual.

- The sensor is connected to a communication port on the EK80. The sensor is turned on and in normal operation.
- The interface port is set up with the correct communication parameters.
- You are familiar with NMEA and other relevant datagram formats.
- You know how to set up the parameters for serial and local area network (LAN) communication.
- All relevant vessel drawings, installation reports and/or measurement results are available.
- The EK80 system is turned on and operates normally.
- The vessel is berthed or at sea.

Neither tools nor instruments are required. For connections and communication parameters, see the relevant end-user documentation from the sensor manufacturer.

## Context

In most cases a suitable course gyro is already installed on the vessel. A global positioning system (GPS) with a compatible output format can also be used.

The properties of each of the available communication ports are defined on the **I/O Setup** page. The **Sensor Installation** page allows your EK80 to communicate with external sensors and systems. To make sure that the information from the "most reliable" sensors are used by the EK80, use the **Sensor Configuration** page to define a datagram priorities.

The communication parameters defined for NMEA 0183 are:

- **Baud rate:** 4800 bit/s
- **Data bits:** 8
- **Parity:** Even
- **Stop bits:** 1

### Procedure

- 1 Open the **Setup** menu.
- 2 On the **Setup** menu, select **Installation**.

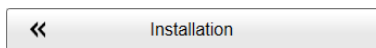

Observe that the **Installation** dialog box opens. This dialog box contains a number of pages selected from the menu on the left side.

- 3 On the left side of the **Installation** dialog box, select **Sensor Installation**.
  - a Select the relevant sensor in the **Installed Sensors** list.
  - b Make sure that the correct installation parameters are used for the sensor.
- 4 On the left side of the **Installation** dialog box, select **Sensor Configuration**.
  - a Select the relevant sensor in the **Sensor** list.
  - b Make sure that the correct parameters are used for sensor configuration.
- 5 Close the **Installation** dialog box without making any changes.
- 6 Observe the top bar.
- 7 Make sure that the information from the sensor is displayed.
 

If necessary, enable the read-out in the **Display Options** dialog box.
- 8 If possible, use another instrument to verify that the information provided by the EK80 is correct.
- 9 Fill in the result tables.

### Result

Datagram	Port	Baud rate	Talker ID

X Offset	Y Offset	Z Offset

Requirements	Results
Heading data is provided and displayed.	
The relevant communication parameters are recorded.	
Date and signature:	

### Related topics

[Test procedures, page 256](#)

## Verifying the communication with a navigation system (GPS)

For the EK80 to use and offer correct navigational information, one or more external sensors must be connected. The communication with the sensor is tested.

### Prerequisites

The EK80 hardware units are installed as specified in this manual.

- The sensor is connected to a communication port on the EK80. The sensor is turned on and in normal operation.
- The interface port is set up with the correct communication parameters.
- You are familiar with NMEA and other relevant datagram formats.
- You know how to set up the parameters for serial and local area network (LAN) communication.
- All relevant vessel drawings, installation reports and/or measurement results are available.
- The EK80 system is turned on and operates normally.
- The vessel is berthed or at sea.

Neither tools nor instruments are required. For connections and communication parameters, see the relevant end-user documentation from the sensor manufacturer.

### Context

Most global positioning system (GPS) receivers provide NMEA 0183 datagrams containing geographical latitude and longitude information, as well as current speed and sailed distance. Some GPS systems will also provide the current heading, but this information is normally taken from the gyro.

The properties of each of the available communication ports are defined on the **I/O Setup** page. The **Sensor Installation** page allows your EK80 to communicate with external

sensors and systems. To make sure that the information from the "most reliable" sensors are used by the EK80, use the **Sensor Configuration** page to define a datagram priorities.

The communication parameters defined for NMEA 0183 are:

- **Baud rate:** 4800 bit/s
- **Data bits:** 8
- **Parity:** Even
- **Stop bits:** 1

Some instruments may provide other parameters and/or options. You must always check the relevant technical documentation supplied by the manufacturer.

### Procedure

- 1 Open the **Setup** menu.
- 2 On the **Setup** menu, select **Installation**.

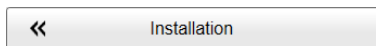

Observe that the **Installation** dialog box opens. This dialog box contains a number of pages selected from the menu on the left side.

- 3 On the left side of the **Installation** dialog box, select **Sensor Installation**.
  - a Select the relevant sensor in the **Installed Sensors** list.
  - b Make sure that the correct installation parameters are used for the sensor.
- 4 On the left side of the **Installation** dialog box, select **Sensor Configuration**.
  - a Select the relevant sensor in the **Sensor** list.
  - b Make sure that the correct parameters are used for sensor configuration.
- 5 Close the **Installation** dialog box without making any changes.
- 6 Observe the top bar.
- 7 Make sure that the information from the sensor is displayed.
 

If necessary, enable the read-out in the **Display Options** dialog box.
- 8 If possible, use another instrument to verify that the information provided by the EK80 is correct.
- 9 Fill in the result tables.

### Result

Sensor	Source sensor	Datagram	Port	Baud rate
Position				
Speed				
Distance				
Heading				

X Offset	Y Offset	Z Offset

Requirements	Results
Position data is provided.	
Speed data is provided.	
Distance data is provided.	
Heading data is provided.	
The relevant communication parameters are recorded.	
Date and signature:	

### Related topics

[Test procedures, page 256](#)

## Verifying the communication with speed log

Without the input from a speed log, the EK80 will not be able to present correct navigational information. The vessel speed is shown on the top bar if you have enabled this in the **Display Options** dialog box. The communication with the sensor is tested.

### Prerequisites

The EK80 hardware units are installed as specified in this manual.

- The sensor is connected to a communication port on the EK80. The sensor is turned on and in normal operation.
- The interface port is set up with the correct communication parameters.
- You are familiar with NMEA and other relevant datagram formats.
- You know how to set up the parameters for serial and local area network (LAN) communication.
- All relevant vessel drawings, installation reports and/or measurement results are available.
- The EK80 system is turned on and operates normally.
- The vessel is berthed or at sea.

Neither tools nor instruments are required. For connections and communication parameters, see the relevant end-user documentation from the sensor manufacturer.

### Context

In most cases a suitable sensor is already installed on the vessel. A global positioning system (GPS) with a compatible output format can also be used.

The properties of each of the available communication ports are defined on the **I/O Setup** page. The **Sensor Installation** page allows your EK80 to communicate with external sensors and systems. To make sure that the information from the "most reliable" sensors are used by the EK80, use the **Sensor Configuration** page to define a datagram priorities.

The communication parameters defined for NMEA 0183 are:

- **Baud rate:** 4800 bit/s
- **Data bits:** 8
- **Parity:** Even
- **Stop bits:** 1

### Procedure

- 1 Open the **Setup** menu.
- 2 On the **Setup** menu, select **Installation**.

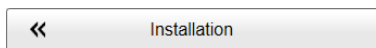

Observe that the **Installation** dialog box opens. This dialog box contains a number of pages selected from the menu on the left side.

- 3 On the left side of the **Installation** dialog box, select **Sensor Installation**.
  - a Select the relevant sensor in the **Installed Sensors** list.
  - b Make sure that the correct installation parameters are used for the sensor.
- 4 On the left side of the **Installation** dialog box, select **Sensor Configuration**.
  - a Select the relevant sensor in the **Sensor** list.
  - b Make sure that the correct parameters are used for sensor configuration.
- 5 Close the **Installation** dialog box without making any changes.
- 6 Observe the top bar.
- 7 Make sure that the information from the sensor is displayed.
 

If necessary, enable the read-out in the **Display Options** dialog box.
- 8 If possible, use another instrument to verify that the information provided by the EK80 is correct.
- 9 Fill in the result tables.

### Result

Datagram	Port	Baud rate	Talker ID

Requirements	Results
Speed data is provided and displayed.	
The relevant communication parameters are recorded.	
Date and signature:	

### Related topics

[Test procedures, page 256](#)

## Verifying the communication with the motion reference unit (MRU)

The information from a motion reference unit (MRU) (normally heave, roll and pitch information) is imported into the EK80 to increase the accuracy of the echo data. The communication with the sensor is tested. This task is only applicable if you are using an external motion reference unit on your EK80.

### Prerequisites

The EK80 hardware units are installed as specified in this manual.

- The sensor is connected to a communication port on the EK80. The sensor is turned on and in normal operation.
- The interface port is set up with the correct communication parameters.
- You are familiar with NMEA and other relevant datagram formats.
- You know how to set up the parameters for serial and local area network (LAN) communication.
- All relevant vessel drawings, installation reports and/or measurement results are available.
- The EK80 system is turned on and operates normally.
- The vessel is berthed or at sea.

Neither tools nor instruments are required. For connections and communication parameters, see the relevant end-user documentation from the sensor manufacturer.

### Context

A motion reference unit (MRU) measures the vessel's pitch and roll movements in the sea. The information provided by the motion sensor is used by the EK80 to stabilize the beams and the echo presentation.

### Procedure

- 1 Open the **Setup** menu.

- 2 On the **Setup** menu, select **Installation**.



- 3 On the left side of the **Installation** dialog box, select **Motion Reference Unit**.
  - a If you use the motion sensor in the Motor Control Unit on the hull unit, make sure that **LAN** is selected.

The sensor uses a local area network (LAN) port on your Processor Unit. A message on the page verifies that it is connected to the EK80 beamformer application.

- b If you use an external motion reference unit (MRU), make sure that a COM port is selected, and that the correct parameters are provided.
- 4 On the left side of the **Installation** dialog box, select **Installation Parameters** to open the page.
  - a Open the **MRU** (Motion Reference Unit) page.
  - b Make sure that the installation parameters for the motion sensor (offset and rotation) are correct.

The physical location of the sensor (X, Y and Z offsets) must be extracted from the detailed vessel drawings, or from the reports provided by the personnel that did the actual installation. The information about the installation angles must be extracted from the reports provided by the personnel that did or measured up the actual installation.

- 5 Close the **Installation** dialog box without making any changes.
- 6 Observe the top bar.
- 7 Make sure that the information from the sensor is displayed.  
If necessary, enable the read-out in the **Display Options** dialog box.

**Note**

---

*In order to read the motion compensation values, the EK80 must be "pinging".*

---

- 8 If possible, use another instrument to verify that the information provided by the EK80 is correct.
- 9 Fill in the result tables.

**Result**

Port	Baud rate	Protocol



X Offset	Y Offset	Z Offset

Rotation Around X	Rotation Around Y	Rotation Around Z

Requirements	Results
Motion compensation is operational.	
The compensated values are shown.	
Date and signature:	

### Related topics

[Test procedures, page 256](#)

## Verifying the communication with a synchronization system

Whenever more than one hydroacoustic system is installed on a vessel, interference may occur. The EK80 offers functionality for remote transmit synchronization. It can be set up to operate in either *Master* or *Slave* mode. Synchronization is required in order to avoid interference if the EK80 is used simultaneously with other hydroacoustic instruments within the same frequency range. You do not need to do this test if the EK80 shall only operate in *Standalone* mode.

### Prerequisites

The EK80 is installed as specified in this manual. To make sure that the the interface is functional, a relevant synchronization system must be connected to the EK80.

- The EK80 system is turned on and operates normally.
- For "slave" operation, a remote system (for example *K-Sync* or *Simrad TU40*) must be available to provide trigger pulses.
- For "master" operation, a remote hydroacoustic system (sonar, echo sounder) is connected. This remote system must be set up in "slave" mode.
- The vessel is berthed or at sea.

Neither tools nor instruments are required.

### Context

Whenever more than one hydroacoustic system is installed on a vessel, interference may occur. To avoid interference, you have these options:

- The systems are all connected to a common synchronization system.

- One of the acoustic systems is set up as "master", and controls the transmissions on the other systems.

**Procedure**

- 1 Test the synchronization when EK80 operates in *Master* mode.
  - a On the **Setup** menu, select **Installation**.
  - b Select **Synchronization**.
  - c Record the communication parameters in the result table.
  - d Select synchronization mode.
  - e Select the synchronization delay.
  - f Make sure that relevant hydroacoustic systems connected to the EK80 are synchronized.
- 2 Test the synchronization when EK80 operates in *Slave* mode.
  - a Make sure that the synchronization system is connected.
  - b On the **Setup** menu, select **Installation**.
  - c Select **Synchronization**.
  - d Record the communication parameters in the result table.
  - e Select synchronization mode.
  - f Select the synchronization delay.
  - g Make sure that the EK80 operates normally when triggered by the remote synchronization system.

**Result**

Sensor	Source system	Port
Synchronization		

Requirements	Results
The external synchronization system is connected to provide trigger pulses (if relevant).	
The EK80 operates in <i>Slave</i> mode.	
The EK80 operates in <i>Master</i> mode.	
Relevant communication parameters are recorded.	
The EK80 operates while additional hydroacoustic systems (sonars, echo sounders) are in synchronized operation.	
Date and signature:	

**Related topics**

[Test procedures, page 256](#)

## Making a noise/speed curve to determine vessel noise

The performance of the EK80 will always be limited by different noise sources. During the Installation Manual, accurate noise measurements are done for different vessel speeds. The weather and sea conditions for the noise measurements will be those at the time of the test.

### Prerequisites

The EK80 system is turned on and operates normally. All the relevant transceivers have been set up, and they are operational with their respective transducers.

You need the following equipment:

- Personal computer
- Spreadsheet program

### Context

In order to measure the noise, you must record the noise value using the tooltip in the echogram. Since the noise will vary with each ping, you must make five measurements for each vessel speed, and then calculate the average noise. You must measure the noise for each single channel, but you can do all these measurements simultaneously.

#### Tip

---

*If you record all the raw data during the noise test, you can repeat the test later using the replay file. You may then use more than five noise samples for each vessel speed to make a more accurate curve.*

---

### Procedure

- 1 To select *Passive* mode, use the **Normal Operation** dialog box.
  - a Open the **Operation** menu.
  - b Select **Normal Operation**.
  - c For each transceiver channel, set **Mode** to *Passive*.
  - d Select **OK** to save the selected settings and close the dialog box.

#### Note

---

*If you set **Mode** to *Passive*, your EK80 will no longer provide any information in the echogram(s).*

---

- 2 Enable the **Noise** tooltip.
  - a Open the **Display** menu.
  - b Select **Display Options** to open the dialog box.
  - c Select **Tooltip** to open the page.
  - d Select **Noise** to enable the tooltip.

- e Select **OK** to save the selected setting and close the dialog box.
- 3 Establish a separate communication line with the bridge to verify the vessel speed during the test.
- 4 Measure the acoustic noise versus the vessel speed.  
Start raw data recording.  
Repeat the following cycle for each vessel speed:
  - a Ask the bridge to set the speed.
  - b Once the bridge reports that the speed has been obtained, select **Event** on the toolbar.
  - c If possible, verify the vessel speed on the top bar.
  - d For each channel, place the cursor five different places on the echogram on the right side of the event marker, and record the noise values.
  - e Calculate the average noise in each channel, and record it in the table.  
(If you find it more convenient, type the data directly into the spreadsheet.)
  - f Ask the bridge to set the next speed.Stop the recording.
- 5 When all the measurements have been made, type the data (speed and noise) into a spreadsheet to create the curve.
- 6 Save the data using a unique file name that identifies context, date, time and vessel. Attach the data file to the electronic copy of the test report.
- 7 Measure the flow noise versus the vessel speed.  
For each channel:
  - a Start raw data recording.
  - b Ask the bridge to increase the vessel speed to maximum.
  - c Wait until maximum speed has been obtained.
  - d Ask the bridge to abruptly turn off all engine power and - if possible - change the pitch of the propellers to zero.
  - e Read the vessel speed on the top bar.
  - f Place the cursor in the approximate centre of the echogram, and observe the tooltip information.
  - g For every two knots the speed is reduced, read the noise.  
(If you find it more convenient, type the data directly into the spreadsheet.)
  - h Fill in the result table.
  - i Stop the recording.
- 8 When all the measurements have been made, type the data (speed and noise) into a spreadsheet to create the curve.

- 9 Save the data using a unique file name that identifies context, date, time and vessel. Attach the data file to the electronic copy of the test report.

### Result

Speed/Noise						
Speed	M1	M2	M3	M4	M5	Average
1						
2						
3						
4						
5						
6						
7						
8						
9						
10						
11						
12						
13						
14						
15						
16						
17						
18						
19						
20						
<b>Channel:</b>						
<b>Sea state:</b>						
Use this table to record the values. Alternatively, you can type the values straight into a spreadsheet. Make the necessary copies so that you have one table for each channel.						

Speed/Flow noise	
Speed	M1
20	
18	
16	
14	
12	
10	

Speed/Flow noise	
Speed	M1
8	
6	
4	
2	
0	
<b>Channel:</b>	
<b>Sea state:</b>	

Use this table to record the values. Alternatively, you can type the values straight into a spreadsheet. Make the necessary copies so that you have one table for each channel.

Test requirements	Results
A noise/speed curve is created.	
Date and signature:	

**Related topics**

[Test procedures, page 256](#)

## Turning off the EK80

You must never turn off the EK80 by means of the on/off switch on the Processor Unit. You must always close the EK80 program by selecting **Exit** on the top bar.

**Context**

When you do not use the EK80, turn off the display and the Processor Unit. If you are not using the EK80 for a long period of time, we recommend that you turn off the Wide Band Transceiver (WBT). Use the on/off switch on the power supply, or disengage the circuit breakers.

**Procedure**

- 1 Select **Exit** on the top bar.

Observe that the EK80 program closes down.

Tip \_\_\_\_\_

*If the EK80 Processor Unit is used as a server with one or more clients connected, a relevant message will appear. We recommend that you turn these clients off first. Closing down the EK80 program with clients connected will take longer time.*

---

2 If the Processor Unit does not turn itself off automatically, use the functionality provided by the operating system to turn it off manually.

3 Turn off the display.

If required, refer to the instructions provided by the display manufacturer.

4 Turn off each transceiver.

The Wide Band Transceiver (WBT) is not fitted with an on/off switch. You can leave the unit permanently turned on. If you are not using the EK80 for a long period of time, turn off or disconnect the power supply.

## Installation remarks

Use this page to write down comments and remarks related to the EK80 installation. When the installation has been fully completed, and all functional tests have been made to full satisfaction, representatives from each party must sign.

<b>Vessel/Customer</b>	
<b>Place and date</b>	
<b>Comments</b>	

### Signatures

<b>Installation done by</b>	<b>Company/Position</b>	<b>Date and signature</b>
<b>Installation accepted by</b>	<b>Company/Position</b>	<b>Date and signature</b>



# Technical specifications

## Topics

[Introduction to technical specifications, page 280](#)

[Interface specifications, page 281](#)

[Power requirements, page 292](#)

[Weights and outline dimensions, page 295](#)

[Environmental requirements, page 298](#)

[Compass safe distance, page 301](#)

[Minimum computer requirements, page 303](#)

[Minimum display requirements, page 304](#)

## Introduction to technical specifications

These technical specifications summarize the main functional and operational characteristics of the EK80 Wide band scientific echo sounder. They also provide information related to power requirements, physical properties and environmental conditions.

The EK80 software supports several different transceiver units. The information is mainly prepared for EK80 installations on a vessel. One or more Wide Band Transceiver (WBT) units are provided. For technical specifications about other transceivers supported by the EK80, see the relevant publications.

### Note

---

*At Kongsberg Maritime, we are continuously working to improve the quality and performance of our products. The technical specifications may be changed without prior notice.*

---

### Related topics

[Technical specifications, page 279](#)

## Interface specifications

The EK80 will interface with peripheral systems and sensors using standard and/or proprietary datagram formats.

For more detailed information about datagrams and file formats, refer to the dedicated EK80 *Interface Specifications* publication.

### Topics

[Supported datagram formats for annotation data, page 281](#)

[Supported datagram formats for distance information, page 282](#)

[Supported datagram formats for drop keel offset information, page 282](#)

[Supported datagram formats for external depth input, page 283](#)

[Supported datagram formats for position information, page 283](#)

[Supported datagram formats for heading and gyro information, page 284](#)

[Supported datagram formats for trawl information, page 284](#)

[Supported datagram formats for motion information, page 285](#)

[Supported datagram formats for palette control, page 286](#)

[Supported datagram formats for catch monitoring information, page 286](#)

[Supported datagram formats for sound speed sensors, page 287](#)

[Supported datagram formats for speed log information, page 288](#)

[Supported datagram formats for temperature information, page 288](#)

[Supported datagram formats for water level offset information, page 289](#)

[Supported formats for processed data to output, page 289](#)

[Supported formats for processed data to file, page 290](#)

### Supported datagram formats for annotation data

When you study an echogram, it is often useful to add personal comments to it. Comments can be used to identify specific events such as specific echoes, unusual bottom conditions, or simply for keeping track of time or distance. You can add annotations manually, or import information as datagrams using a serial or LAN (Ethernet) communication port.

The EK80 supports the following datagram format for annotations.

- **ATS Annotation**

ATS Annotation is a proprietary datagram format created by Kongsberg Maritime. It allows you to import text annotations from external devices.

### Related topics

[Interface specifications, page 281](#)

[Technical specifications, page 279](#)

## Supported datagram formats for distance information

In this maritime context, *distance* refers to the physical travelled distance the vessel has made since the sensor was last reset. A suitable external sensor must be provided. A global positioning system (GPS) with a compatible output format can also be used. When enabled, the navigational information on the top bar includes a read-out of the vessel's travelled distance.

The EK80 supports the following datagram format for vessel distance information.



- **NMEA VLW**

The NMEA VLW datagram contains the travelled distance of the vessel. Two values are provided; relative to the water and over the ground.

### Related topics

[Interface specifications, page 281](#)

[Technical specifications, page 279](#)

## Supported datagram formats for drop keel offset information

If your vessel is equipped with a drop keel, the operating depth of the transducer face will vary. This variation affects the position of the transducer in the vessel's coordinate system. To make accurate measurements, this offset must be compensated.

The EK80 supports the following datagram format for drop keel offset information.

- **OFS Drop keel**

The proprietary OFS datagram contains the current length travelled by the drop keel. The information is required to establish the offset of the transducer face relative to the vessel origin. A custom-built sensor may be required for this measurement.

### Related topics

[Interface specifications, page 281](#)

[Technical specifications, page 279](#)

## Supported datagram formats for external depth input

The EK80 can receive depth information from an external echo sounder.

The EK80 supports the following datagram format for depth information from an echo sounder:

- **NMEA DPT**

The NMEA DPT datagram provides the water depth relative to the transducer, and the offset of the measuring transducer.

### Related topics

[Interface specifications, page 281](#)

[Technical specifications, page 279](#)

## Supported datagram formats for position information

Accurate and reliable information from navigation systems are useful for the EK80 operation. When enabled, the vessel's current geographical position is shown on the top bar.

The EK80 supports the following datagram formats for position information.



59° 27.270<sub>N</sub>  
010° 27.103<sub>E</sub>

- **NMEA GLL**

The NMEA GLL datagram transfers the latitude and longitude of vessel position, the time of the position fix and the current status from a global positioning system (GPS).

- **NMEA GGA**

The NMEA GGA datagram transfers time-, position- and fix-related data from a global positioning system (GPS).

- **NMEA GGK**

The NMEA GGK datagram is used to decode the PTNL, Time, Position, Type and DOP (Dilution of Precision) string of the NMEA 0183 output.

- **PTNL GGK**

PTNL GGK is a proprietary datagram from Trimble (<https://www.trimble.com>). It is longer than the standard NMEA GGK datagram. The PTNL GGK datagram is used to decode the time, position, type and dilution of precision of the current position.

- **NMEA RMC**

The NMEA RMC datagram transfers the time, date, position, course and speed data from a global navigation satellite system (GNSS) receiver.

- **NMEA VTG**

The NMEA VTG datagram contains the actual course and speed relative to the ground.

- **NMEA ZDA**

The NMEA ZDA datagram contains the universal time code (UTC), day, month, year and local time zone.

**Related topics**

[Interface specifications, page 281](#)

[Technical specifications, page 279](#)

## Supported datagram formats for heading and gyro information

The heading sensor provides the EK80 with the vessel's current heading. When enabled, the vessel's current heading is shown on the top bar.

The EK80 supports the following datagram formats for vessel heading and/or gyro information.

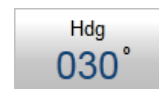

- **NMEA HDT**

The NMEA HDT datagram provides the true vessel heading. The information is normally provided by a course gyro.

- **NMEA HDM**

The NMEA HDM datagram provides vessel heading in degrees magnetic. The datagram is no longer recommended for use in new designs. It is often replaced by the NMEA HDG telegram.

- **NMEA HDG**

The NMEA HDG datagram provides heading from a magnetic sensor. If this reading is corrected for deviation, it produces the magnetic heading. If it is offset by variation, it provides the true heading.

- **NMEA THS**

The NMEA THS datagram provides the true vessel heading. The datagram includes a mode indicator field providing critical safety-related information about the heading data. The THS datagram replaces the deprecated HDT.

**Related topics**

[Interface specifications, page 281](#)

[Technical specifications, page 279](#)

## Supported datagram formats for trawl information

The data communication from an external trawl system is based on proprietary data formats.

The EK80 supports the following datagram formats from a trawl system:

- **Simrad DBS**

Simrad DBS is a proprietary datagram format created by Kongsberg Maritime to provide the current depth of the trawl sensor.

- **Simrad HFB**

Simrad HFB is a proprietary datagram format created by Kongsberg Maritime. It provides the vertical distance (height) from the headrope to the footrope, and from the headrope to the bottom. The heights are measured by an ITI TrawlEye or a height sensor. If you use two height sensors, the information from the second sensor is provided in the Simrad HB2 datagram.

- **Simrad TDS**

Simrad TDS is a proprietary datagram format created by Kongsberg Maritime to provide the door spread. That is the distance between the two trawl doors. In a dual trawl system, the distance between the second door set is provided in the Simrad TS2 datagram.

- **Simrad TPR**

Simrad TPR is a proprietary datagram format created by Kongsberg Maritime. It provides the relative bearing and water depth of the trawl sensor, as well as its distance from the vessel. The bearing resolution is 1 degree. The Simrad ITI measures the depth differently from the range and the bearing. If the ITI only knows the range and the bearing, the depth field is empty.

- **Simrad TPT**

Simrad TPT is a proprietary datagram format created by Kongsberg Maritime to provide the true bearing and water depth of the trawl sensor, as well as its distance from the vessel. The bearing resolution is 1 degree.

### Related topics

[Interface specifications, page 281](#)

[Technical specifications, page 279](#)

## Supported datagram formats for motion information

The EK80 will interface with peripheral systems and sensors using standard and/or proprietary datagram formats. When enabled, the navigational information on the top bar includes the vessel's current roll, pitch and heave movements.

The EK80 supports the following datagram formats from a motion sensor.

Heave	Pitch	Roll
3.1	3.5°	2.9°

- **KM Binary**

KM Binary is a generic datagram format defined by Kongsberg Maritime. This format has very high resolution on timing and sensor parameters.

- **Kongsberg EM Attitude 3000**

The Kongsberg EM Attitude 3000 is a proprietary datagram format created by Kongsberg Maritime for use with digital motion sensors. It holds roll, pitch, heave and heading information.

- **Furuno GPhve**

Furuno GPhve is a proprietary datagram format created by Furuno (<http://www.furuno.jp>) to contain heave information.

- **Hemisphere GNSS GPHEV**

GPHEV is a proprietary datagram format created by Hemisphere GNSS (<https://hemispheregnss.com>) to contain heave information.

- **Teledyne TSS1**

Teledyne TSS1 is a proprietary datagram format created by Teledyne TSS Navigation Systems for heave, roll and pitch compensation. When you select this protocol, the number of sensor variables is fixed, and there is no token associated with it.

#### **Related topics**

[Interface specifications, page 281](#)

[Technical specifications, page 279](#)

## Supported datagram formats for palette control

On some vessels, the EK80 is used as an integrated part of a large information system. In such cases, the host system may offer a common palette control. This allows you to select a common colour scheme ("skin") used in all the presentations.

The EK80 supports the following datagram format for palette control:

- **NMEA DDC**

The NMEA DDC (Display Dimming and Control) datagram format allows you to remotely control the colour palette and brightness of the EK80 display presentations.

#### **Related topics**

[Interface specifications, page 281](#)

[Technical specifications, page 279](#)

## Supported datagram formats for catch monitoring information

The data communication from an external catch monitoring system is based on proprietary data formats.

The EK80 supports the following datagram formats from a catch monitoring system.



- **Simrad PSIMP D**

Simrad PSIMP D is a proprietary datagram format created by Kongsberg Maritime to provide the type and configuration of PS and PI sensors used by a Simrad catch monitoring system. This datagram format is obsolete, and it is no longer in use on new designs. It has been replaced by datagram PSIMP D1.

- **Simrad PSIMP D1**

Simrad PSIMP D1 is a proprietary datagram format created by Kongsberg Maritime to provide the type and configuration of PS, PI and PX sensors used by a Simrad catch monitoring system. This datagram format replaces the PSIMP D format.

- **Simrad PSIMP F**

Simrad PSIMP F is a proprietary datagram format created by Kongsberg Maritime to provide the type and configuration of PS and PI sensors used by a Simrad catch monitoring system.

### Related topics

[Interface specifications, page 281](#)

[Technical specifications, page 279](#)

## Supported datagram formats for sound speed sensors

The **Profile** page in the **Environment** dialog box shows the current sound speed profile. You can select a new profile provided by a CTD (Conductivity, Temperature, Depth) sensor.

The EK80 supports the following datagram format from a sound speed sensor.

- **AML Sound speed**

AML is a third-party proprietary datagram format created by AML Oceanographic (<http://www.amloceanographic.com>) for use with their sound velocity probes. The sound velocity probe output is configurable. The code is searching for a value between 1300 and 1800 and uses it as the sound speed.

### Related topics

[Interface specifications, page 281](#)

[Technical specifications, page 279](#)

## Supported datagram formats for speed log information

An external speed sensor is typically a global positioning system (GPS) or a dedicated speed log. When enabled, the vessel's current speed is shown on the top bar.

The EK80 supports the following datagram formats for speed information.

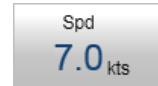

- **NMEA VTG**

The NMEA VTG datagram contains the actual course and speed relative to the ground.

- **NMEA VBW**

The NMEA VBW datagram contains water- and ground-referenced vessel speed data.

- **NMEA VHW**

The NMEA VHW datagram contains the compass heading to which the vessel points, and the speed of the vessel relative to the water.

- **NMEA CUR**

The NMEA CUR datagram contains multi-layer water current data. This includes the depth and speed of the current.

### Related topics

[Interface specifications, page 281](#)

[Technical specifications, page 279](#)

## Supported datagram formats for temperature information

The navigational information on the top bar may include a read-out of the current water temperature.

If a suitable sensor is connected to the EK80 Processor Unit, the top bar may show you the current temperature. The function is offered to allow you to monitor the water temperature, but it will display any temperature reading that is made by the sensor.

The EK80 supports the following datagram format from temperature sensors:



- **NMEA MTW**

The NMEA MTW datagram provides the current water temperature.

### Related topics

[Interface specifications, page 281](#)

[Technical specifications, page 279](#)

## Supported datagram formats for water level offset information

Many factors can cause the ship's draft to change. The amount of fuel, cargo or ballast may greatly influence the draft. Varying water temperatures and salinity will also have an effect. Draft changes will make any sensor move vertically on the X-axis when referenced to the sea surface. To keep measurements accurate, the location of the water line must therefore be monitored.

The EK80 supports the following datagram format for water level offset information:

- **DFT Water Level**

The proprietary DFT datagram contains the current water level (draft). The information is required to establish the offset of the transducer face relative to the vessel origin. A custom-built sensor may be required for this measurement.

### Related topics

[Interface specifications, page 281](#)

[Technical specifications, page 279](#)

## Supported formats for processed data to output

The EK80 can export several types of processed data to a communication port. Use **Processed Data to Output** to define which processed data formats to export, and which communication port to use. This page is located in the **Output** dialog box.

The following formats are supported:

- **XYZ file format**

This is processed and interpolated "xyz" data in ASCII format. The XYZ datagram is a navigational datagram showing the position and depth of a single channel.

- **ZMQ Beam Velocity**

ZMQ Beam Velocity identifies the datagram format used to export data to the UHDAS (University of Hawaii Data Acquisition System) processing software. The UHDAS processing software uses the ZMQ Beam Velocity (Zero Message Queue) datagram format to set up sockets and communication. For more information about the proprietary UHDAS format, visit [currents.soest.hawaii.edu/uhdas\\_home](http://currents.soest.hawaii.edu/uhdas_home).

- **NMEA DBS**

The NMEA DBS datagram provides the current depth from the surface. The datagram is no longer recommended for use in new designs. It is frequently replaced by the NMEA DPT datagram format.

- **NMEA DBT**

The NMEA DBT datagram provides the current depth under the transducer. In new designs, this datagram format is frequently used to replace the DBK and DBS formats.

- **NMEA DPT**

The NMEA DPT datagram provides the water depth relative to the transducer, and the offset of the measuring transducer.

- **Atlas Depth**

Atlas Depth is a proprietary datagram format created by Atlas Elektronik (<https://www.atlas-elektronik.com>) to provide the current depth from two channels.

- **Simrad PSIMDHB**

The proprietary Simrad PSIMDHB datagram format is created by Kongsberg Maritime to contain the calculated bottom hardness and biomass information. The bottom depth is given as DBS (depth below surface). It is assumed that correct transducer draft has been provided.

- **NMEA VBW**

The NMEA VBW datagram contains water- and ground-referenced vessel speed data.

- **NMEA VHW**

The NMEA VHW datagram contains the compass heading to which the vessel points, and the speed of the vessel relative to the water.

- **NMEA VTG**

The NMEA VTG datagram contains the actual course and speed relative to the ground.

- **CP1 Current Profile**

The CP1 Current Profile datagram is a proprietary format created by Kongsberg Maritime. The datagram exports the velocity of the water current from the seafloor and from a selection of depth layers in the water column.

### **Related topics**

[Interface specifications, page 281](#)

[Technical specifications, page 279](#)

## **Supported formats for processed data to file**

The EK80 can export several types of processed data file formats. Use **Processed Data to File** to define which processed data formats to save, and where to place the files. This page is located in the **Output** dialog box.

### **Note**

---

*The data files will normally become very large. If you wish to record large amounts of EK80 data, make sure that you have enough space on your hard disk. Unless your Processor Unit is equipped with a very large disk, we recommend that you save the data to an external storage device.*

---

The following formats are supported:

- **XYZ file format**

This is processed and interpolated "xyz" data in ASCII format. The XYZ datagram is a navigational datagram showing the position and depth of a single channel.

- **ADCP-NetCDF**

NetCDF is a proprietary data and metadata convention for storage of data from active sonars. The file format is developed and maintained by ICES (International Council for the Exploration of the Sea). EK80 uses the format NetCDF4, where the number refers to the version of the format. This version includes groups and subgroups into the format.

- **BOT**

The BOT file format is a proprietary file format designed by Kongsberg Maritime to contain configuration and depth information. The BOT data file contains a set of *datagrams*. The datagram sequence is not fixed. It depends on the number of installed frequency channels.

### **Related topics**

[Interface specifications, page 281](#)

[Technical specifications, page 279](#)

## Power requirements

These power characteristics summarize the supply power requirements for the EK80 Wide band scientific echo sounder.

### Topics

[Display power requirements, page 292](#)

[Processor Unit power requirements, page 292](#)

[Wide Band Transceiver \(WBT\) power requirements, page 293](#)

[WBT Power Supply power requirements, page 293](#)

[LBG408A-R2 Ethernet switch power requirements, page 293](#)

[WBT Cabinet power requirements, page 294](#)

### Display power requirements

Not applicable. The display is not a part of the EK80 scope of supply. It is not manufactured by Kongsberg Maritime. For more information, refer to the end-user documentation provided by the manufacturer.

### Related topics

[Power requirements, page 292](#)

[Technical specifications, page 279](#)

### Processor Unit power requirements

- **Model:** EK80 Processor Unit (Enix)
- **Voltage requirement:** 115/230 VAC (Single phase/Nominal voltage)
- **Maximum voltage deviation:** 15%
- **Maximum transient:** 20% of nominal voltage, recovery time 3 s
- **Power consumption:** 500 W @ 230 VAC (Approximately)

The technical specifications are those valid for the computer that provided by Kongsberg Maritime as a part of the EK80 delivery. For specifications related to a locally purchased computer, refer to the documentation provided with the unit.

### Related topics

[Power requirements, page 292](#)

[Technical specifications, page 279](#)

## Wide Band Transceiver (WBT) power requirements

- **Make and model:** Simrad Wide Band Transceiver (WBT)
- **Voltage requirement:** 12 – 15 VDC, 5A  
A suitable power supply is provided with the delivery.
- **Power Supply Unit:**
  - **Make and model:** WBT Power supply
  - **Voltage requirement:** 115/230 VAC, 47 to 63 Hz, single phase, nominal
  - **Maximum voltage deviation:** 15%
  - **Maximum transient:** 20% of nominal voltage, recovery time 3 s
  - **Power consumption:** 100 VA (Approximately)

### Related topics

[Power requirements, page 292](#)

[Technical specifications, page 279](#)

## WBT Power Supply power requirements

- **Make and model:** WBT Power supply
- **Voltage requirement:** 115/230 VAC, 47 to 63 Hz, single phase, nominal
- **Maximum voltage deviation:** 15%
- **Maximum transient:** 20% of nominal voltage, recovery time 3 s
- **Power consumption:** 100 VA (Approximately)

### Related topics

[Power requirements, page 292](#)

[Technical specifications, page 279](#)

## LBG408A-R2 Ethernet switch power requirements

The technical specifications are those valid for the Ethernet switch that was delivered from Kongsberg Maritime as a part of the EK80 delivery. For specifications related to a locally purchased Ethernet switch, refer to the documentation provided with the unit.

- **Manufacturer:** Black Box
- **Manufacturer's website:** <http://www.blackbox.co.uk>
- **Make and model:** Black Box LBG408A-R2
- **Voltage requirement:** 100 - 240 VAC
- **Power consumption:** 15 W (Maximum)

For additional details, refer to the technical specifications provided by the manufacturer.

**Note**

---

*This information was copied from the manufacturer's documentation. To ensure that your information is correct, always consult the manufacturer's own documents.*

---

**Related topics**

[Power requirements, page 292](#)

[Technical specifications, page 279](#)

## WBT Cabinet power requirements

- **Make and model:** Simrad WBT Cabinet
- **Power requirements:** Not applicable.

**Related topics**

[Power requirements, page 292](#)

[Technical specifications, page 279](#)



## Weights and outline dimensions

These weights and outline dimension characteristics summarize the physical properties of the EK80 Wide band scientific echo sounder.

### Topics

[Display weight and outline dimensions, page 295](#)

[Processor Unit weight and outline dimensions, page 295](#)

[Wide Band Transceiver \(WBT\) weight and outline dimensions, page 296](#)

[LBG408A-R2 Ethernet switch weight and outline dimensions, page 296](#)

[WBT Cabinet weight and outline dimensions, page 297](#)

### Display weight and outline dimensions

Not applicable. The display is not a part of the EK80 scope of supply. It is not manufactured by Kongsberg Maritime. For more information, refer to the end-user documentation provided by the manufacturer.

### Related topics

[Weights and outline dimensions, page 295](#)

[Technical specifications, page 279](#)

### Processor Unit weight and outline dimensions

- **Make and model:** EK80 Processor Unit (Enix)
- **Outline dimensions:**
  - **Depth:** 385 mm
  - **Width:** 479.6 mm (Will fit in a 19" rack)
  - **Height:** 177 mm
- **Weight:** 16 kg (Approximately)

The technical specifications are those valid for the computer that provided by Kongsberg Maritime as a part of the EK80 delivery. For specifications related to a locally purchased computer, refer to the documentation provided with the unit.

### Related topics

[Weights and outline dimensions, page 295](#)

[Technical specifications, page 279](#)

[385609 Processor Unit dimensions, page 310](#)

## Wide Band Transceiver (WBT) weight and outline dimensions

- **Make and model:** Simrad Wide Band Transceiver (WBT)
- **Outline dimensions**
  - **Depth:** 213 mm
  - **Width:** 438 mm
  - **Height:** 84 mm
- **Weight:** 5 kg (Approximately)

### Related topics

[Weights and outline dimensions, page 295](#)

[Technical specifications, page 279](#)

[388697 Wide Band Transceiver \(WBT\) outline dimensions, page 308](#)

## LBG408A-R2 Ethernet switch weight and outline dimensions

The technical specifications are those valid for the Ethernet switch that was delivered from Kongsberg Maritime as a part of the EK80 delivery. For specifications related to a locally purchased Ethernet switch, refer to the documentation provided with the unit.

- **Manufacturer:** Black Box
- **Manufacturer's website:** <http://www.blackbox.co.uk>
- **Make and model:** Black Box LBG408A-R2
- **Outline dimensions:**
  - **Depth:** 123 mm
  - **Width:** 228 mm
  - **Height:** 44 mm
- **Weight:** 0.9 kg (Approximately)

For additional details, refer to the technical specifications provided by the manufacturer.

### Note

---

*This information was copied from the manufacturer's documentation. To ensure that your information is correct, always consult the manufacturer's own documents.*

---

### Related topics

[Weights and outline dimensions, page 295](#)

[Technical specifications, page 279](#)

## WBT Cabinet weight and outline dimensions

- **Make and model:** Simrad WBT Cabinet
- **Outline dimensions:**
  - **Depth:** 757 mm (With shock absorbers)
  - **Width:** 607 mm
  - **Height:** 1350 mm (With shock absorbers)
- **Weight:**
  - **Empty:** 80 kg (Approximately)
  - **With seven WBT units:** 150 kg (Approximately)

### Related topics

[Weights and outline dimensions, page 295](#)

[Technical specifications, page 279](#)

[400930 WBT Cabinet outline dimensions, page 314](#)

## Environmental requirements

These environmental specifications summarize the temperature and humidity requirements for the EK80 Wide band scientific echo sounder.

### Topics

[Display environmental requirements, page 298](#)

[Processor Unit environmental requirements, page 298](#)

[Wide Band Transceiver \(WBT\) environmental requirements, page 299](#)

[LBG408A-R2 Ethernet switch environmental requirements, page 299](#)

[WBT Cabinet environmental requirements, page 299](#)

### Display environmental requirements

Not applicable. The display is not a part of the EK80 scope of supply. It is not manufactured by Kongsberg Maritime. For more information, refer to the end-user documentation provided by the manufacturer.

### Related topics

[Environmental requirements, page 298](#)

[Technical specifications, page 279](#)

### Processor Unit environmental requirements

- **Model:** EK80 Processor Unit (Enix)
- **Operating temperature:** -15 to 55 °C
- **Storage temperature:** -20 to 70 °C
- **Relative humidity:** 10 to 95% relative non-condensing
- **Certificates:**
  - IEC 60945
  - IACS E10

The technical specifications are those valid for the computer that provided by Kongsberg Maritime as a part of the EK80 delivery. For specifications related to a locally purchased computer, refer to the documentation provided with the unit.

### Related topics

[Environmental requirements, page 298](#)

[Technical specifications, page 279](#)

## Wide Band Transceiver (WBT) environmental requirements

- **Make and model:** Simrad Wide Band Transceiver (WBT)
- **Operating temperature:** 0 to +50 °C
- **Storage temperature:** -40 to 70 °C
- **Relative humidity:** 5 to 95% relative, non-condensing
- **Ingress protection (IP) rating:** IP52

### Related topics

[Environmental requirements, page 298](#)

[Technical specifications, page 279](#)

## LBG408A-R2 Ethernet switch environmental requirements

The technical specifications are those valid for the Ethernet switch that was delivered from Kongsberg Maritime as a part of the EK80 delivery. For specifications related to a locally purchased Ethernet switch, refer to the documentation provided with the unit.

- **Manufacturer:** Black Box
- **Manufacturer's website:** <http://www.blackbox.co.uk>
- **Make and model:** Black Box LBG408A-R2
- **Operating temperature:** 0 to +45 °C
- **Storage temperature:** -20 to 90 °C
- **Relative humidity:** 10 to 90 % relative non-condensing

For additional details, refer to the technical specifications provided by the manufacturer.

### Note

---

*This information was copied from the manufacturer's documentation. To ensure that your information is correct, always consult the manufacturer's own documents.*

---

### Related topics

[Environmental requirements, page 298](#)

[Technical specifications, page 279](#)

## WBT Cabinet environmental requirements

- **Make and model:** Simrad WBT Cabinet
- **Environmental requirements:** Not applicable.

**Related topics**

[Environmental requirements, page 298](#)

[Technical specifications, page 279](#)

## Compass safe distance

If you place any of the EK80 Wide band scientific echo sounder units on the bridge, you must observe the physical distance to the compass.

### Topics

[Display compass safe distance, page 301](#)

[Processor Unit compass safe distance, page 301](#)

[Wide Band Transceiver \(WBT\) compass safe distance, page 301](#)

[WBT Power Supply compass safe distance, page 302](#)

[LBG408A-R2 Ethernet switch compass safe distance, page 302](#)

[WBT Cabinet compass safe distance, page 302](#)

## Display compass safe distance

Not applicable. The display is not a part of the EK80 scope of supply. It is not manufactured by Kongsberg Maritime. For more information, refer to the end-user documentation provided by the manufacturer.

### Related topics

[Compass safe distance, page 301](#)

[Technical specifications, page 279](#)

## Processor Unit compass safe distance

- **Model:** EK80 Processor Unit (Enix)
- **Standard compass:** 200 cm
- **Other compass:** 140 cm

The technical specifications are those valid for the computer that provided by Kongsberg Maritime as a part of the EK80 delivery. For specifications related to a locally purchased computer, refer to the documentation provided with the unit.

### Related topics

[Compass safe distance, page 301](#)

[Technical specifications, page 279](#)

## Wide Band Transceiver (WBT) compass safe distance

- **Make and model:** Simrad Wide Band Transceiver (WBT)

- **Standard compass:** 30 cm

#### **Related topics**

[Compass safe distance, page 301](#)

[Technical specifications, page 279](#)

## WBT Power Supply compass safe distance

- **Make and model:** WBT Power supply
- **Standard compass:** 30 cm

#### **Related topics**

[Compass safe distance, page 301](#)

[Technical specifications, page 279](#)

## LBG408A-R2 Ethernet switch compass safe distance

The technical specifications are those valid for the Ethernet switch that was delivered from Kongsberg Maritime as a part of the EK80 delivery. For specifications related to a locally purchased Ethernet switch, refer to the documentation provided with the unit.

- **Manufacturer:** Black Box
- **Manufacturer's website:** <http://www.blackbox.co.uk>
- **Make and model:** Black Box LBG408A-R2
- **Standard compass:** Not specified

For additional details, refer to the technical specifications provided by the manufacturer.

#### **Note**

---

*This information was copied from the manufacturer's documentation. To ensure that your information is correct, always consult the manufacturer's own documents.*

---

#### **Related topics**

[Compass safe distance, page 301](#)

[Technical specifications, page 279](#)

## WBT Cabinet compass safe distance

- **Make and model:** Simrad WBT Cabinet
- **Standard compass:** Not applicable.



**Related topics**

[Compass safe distance, page 301](#)

[Technical specifications, page 279](#)

## Minimum computer requirements

Unless specifically ordered from Kongsberg Maritime, the EK80 is not provided with a computer. This item must be purchased locally.

If you purchase a computer locally, make sure that the chosen model meets the functional and technical requirements.

It is important to make sure that the chosen computer model is relatively new with sufficient processing power, a high performance graphic adapter, and a high speed network adapter. The computer must be able to facilitate the various interface requirements made by the EK80, and you may need to add extra Ethernet and serial adapters.

**Note**

---

*The computer design and construction must allow for maritime use, easy access to connectors, parts and cables, and a safe installation.*

---

A laptop computer may be used as long as it meets the functional and technical requirements.

The minimum technical requirements are:

- **Processor:** Intel I7 (or better)

An equivalent type from another manufacturer can also be used.

- **Memory:** minimum capacity 4 GB
- **Hard disk**

If you wish to record large amounts of EK80 data, make sure that you have enough space on your hard disk. Unless your Processor Unit is equipped with a very large disk, we recommend that you save the data to an external storage device.

- **Graphic adapter**

- Minimum resolution (pixels): 1280 x 1024
- Recommended resolution (pixels): 1920 x 1200

The graphic adapter must support DirectX9.0c, and must be compatible with Direct3d and OpenGL. A large number of commercial graphic adapters are available, and we have not tested all of them. Even adapters that meet the minimum specifications may fail with the EK80 software. We welcome any feedback with comments or experiences with graphic adapters.

- **Serial interfaces**

The number of serial lines depends on the interface requirements.

If you have connected a USB-to-serial adapter to the Processor Unit, do not remove it while the EK80 is running. Do not move the adapter to a different USB socket on the Processor Unit.

- **Operating system**

We recommend you to install all Microsoft's latest Windows 10 updates, before installing EK80.

The EK80 software has been designed for Windows 10. Operating systems older than Windows 10 are not supported.

- **Ethernet adapter**

- Type: Intel 82571 (or better)
- Minimum bandwidth: 1 Gb/s

To communicate with the Wide Band Transceiver (WBT), a high quality Ethernet adapter is required. Two adapters are required if the Processor Unit shall also be connected to a local area network (LAN).

The Ethernet adapter communicating with the Wide Band Transceiver (WBT) must offer a **Receive Buffers** function. This parameter must be set to its maximum value if more than one Wide Band Transceiver (WBT) is used.

### **Related topics**

[Technical specifications, page 279](#)

## Minimum display requirements

Unless specifically ordered, the EK80 is not provided with a display. The display must then be purchased locally.

You can use more than one display on your EK80 Processor Unit depending on personal and/or operational preferences.

### **Note**

---

*Make sure that the chosen display meets the EK80 requirements. The design and construction must allow for marine use, and the display must be able to withstand the movements and vibrations normally experienced on a vessel. Verify that you have easy access to cables and connectors, and that the display can be installed in a safe and secure way.*

---

The minimum technical requirements for the display are:

- **Resolution:**
  - **Minimum:** 1280 x 1024 pixels
  - **Recommended:** 1920 x 1200 pixels (or better)
- **Video interface:** The video interface must match the output format(s) provided by the Processor Unit.

The Processor Unit may offer video output on several formats. Investigate your options before you purchase a display.
- **Physical screen size:** The screen size depends on personal and/or operational preferences.

The EK80 software supports 16:9 displays.

Tip

---

*If you use the EK80 with many transceivers, you may find it useful with a large high resolution display.*

---

**Related topics**

[Technical specifications, page 279](#)

# Drawing file

## Topics

[About the drawings in the drawing file, page 307](#)

[388697 Wide Band Transceiver \(WBT\) outline dimensions, page 308](#)

[385609 Processor Unit dimensions, page 310](#)

[400930 WBT Cabinet outline dimensions, page 314](#)

[201575 Transducer connector assembly and wiring, page 318](#)

## About the drawings in the drawing file

Relevant drawings related to the installation and/or maintenance of the EK80 are provided for information purposes only.

### Note

---

*These drawings are provided only for information and planning purposes. Information may be omitted. Observe the source drawings for additional details.*

---

The drawings are not to scale. Unless otherwise specified, all measurements are in millimetres. The original installation drawings are available in PDF and/or AutoCad's DWG format. The original drawings can be downloaded from our website.

<https://www.kongsberg.com/simrad>

Some drawings and documents are not available from our website. These can be downloaded from the *Simrad Dealer Club*.

<https://www.kongsberg.com/sdc>

The installation shipyard must provide all necessary design and installation drawings, as well as the relevant work standards and mounting procedures.

If required, all documents provided by the shipyard for the physical installation of the EK80 must be approved by the vessel's national registry and corresponding maritime authority and/or classification society. Such approval must be obtained before the installation can begin. The shipowner and shipyard doing the installation are responsible for obtaining and paying for such approval.

### Related topics

[Drawing file, page 306](#)

[Simrad EK80, page 13](#)

[Installing the EK80 hardware units, page 64](#)

[Technical specifications, page 279](#)

# 388697 Wide Band Transceiver (WBT) outline dimensions

Download the source drawing from the EK80 pages on <https://www.kongsberg.com/simrad>.

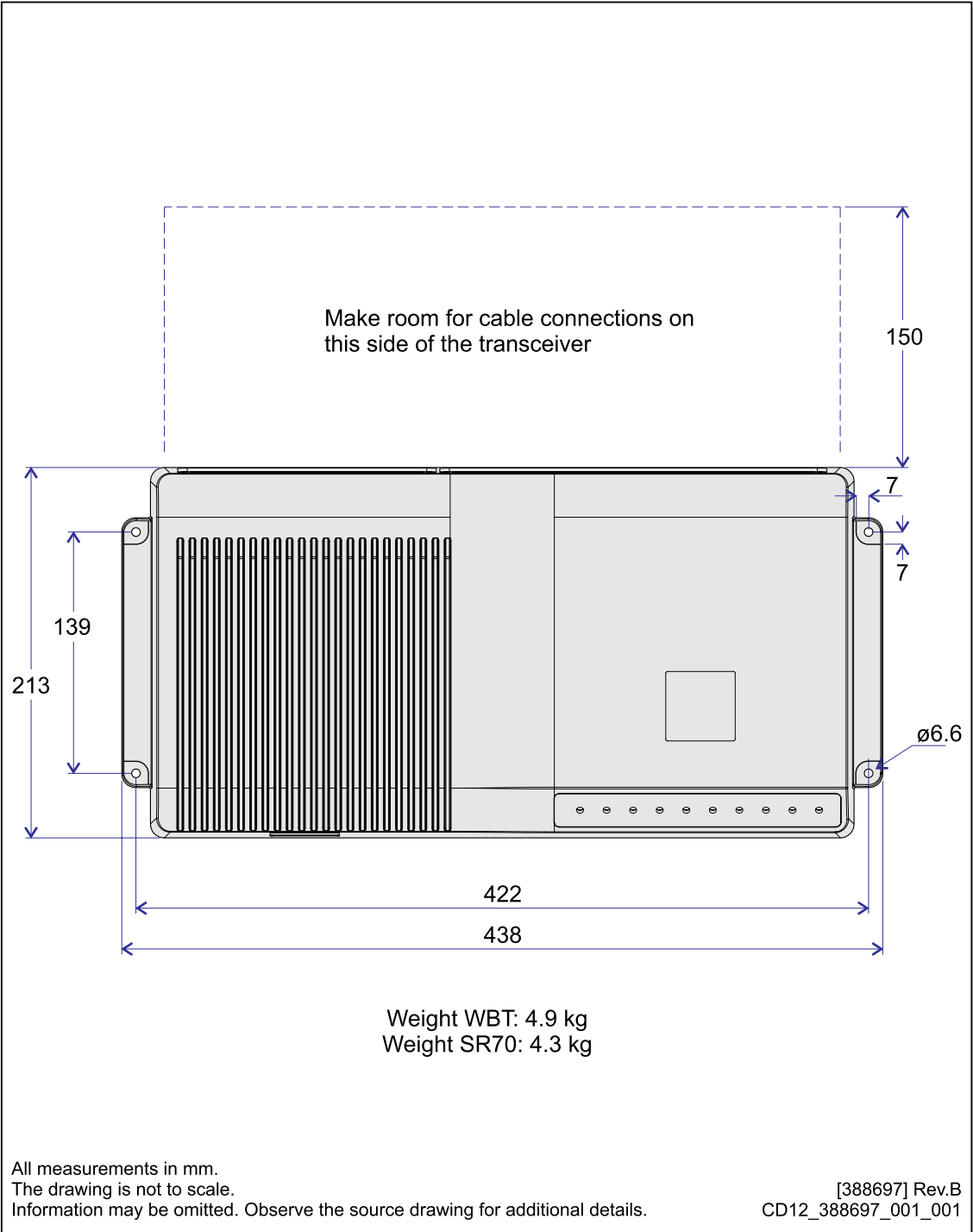

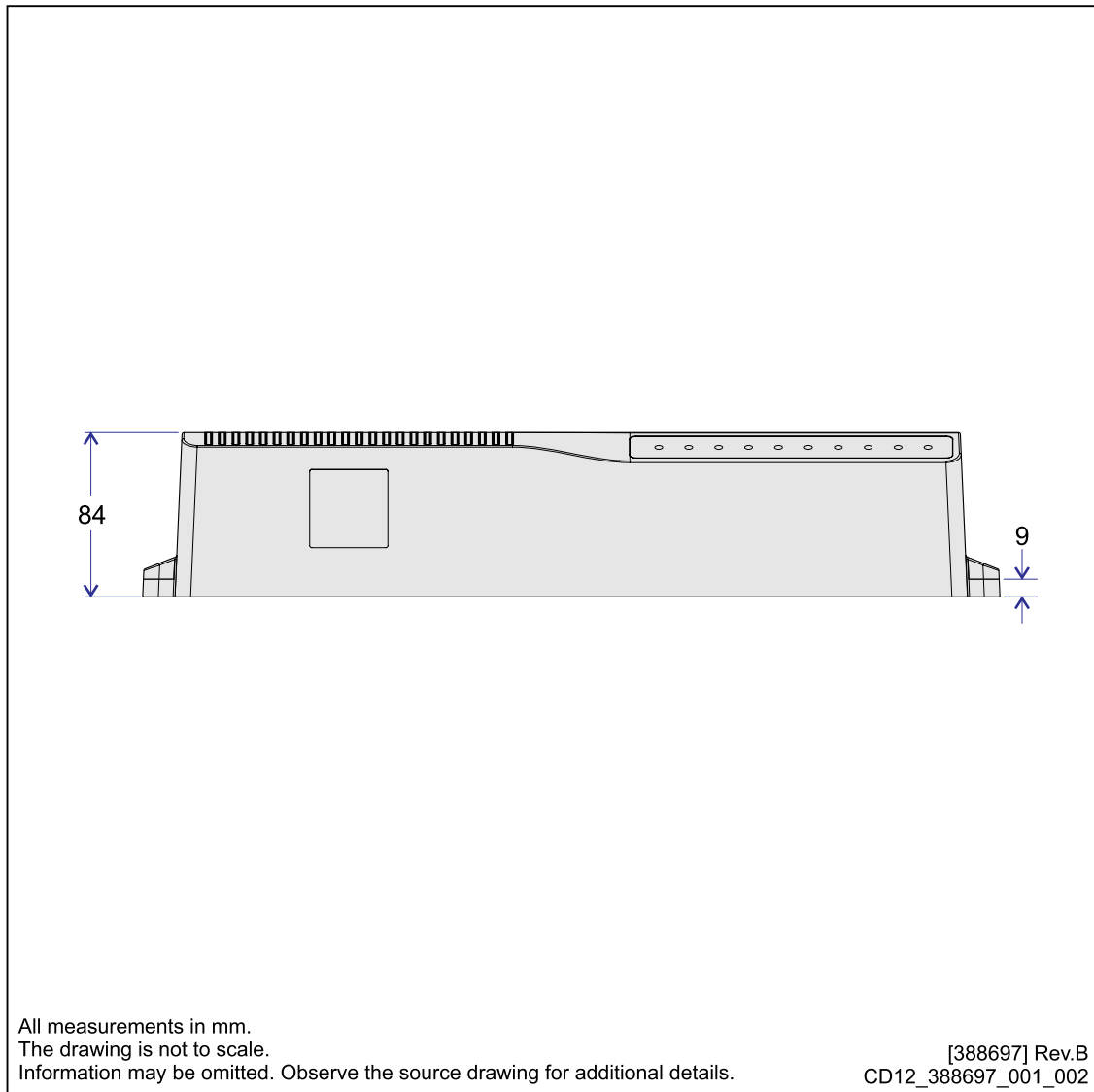

**Related topics**

[Drawing file, page 306](#)

[Simrad EK80, page 13](#)

[Installing the EK80 hardware units, page 64](#)

[Technical specifications, page 279](#)

## 385609 Processor Unit dimensions

Download the source drawing from the EK80 pages on <https://www.kongsberg.com/simrad>.

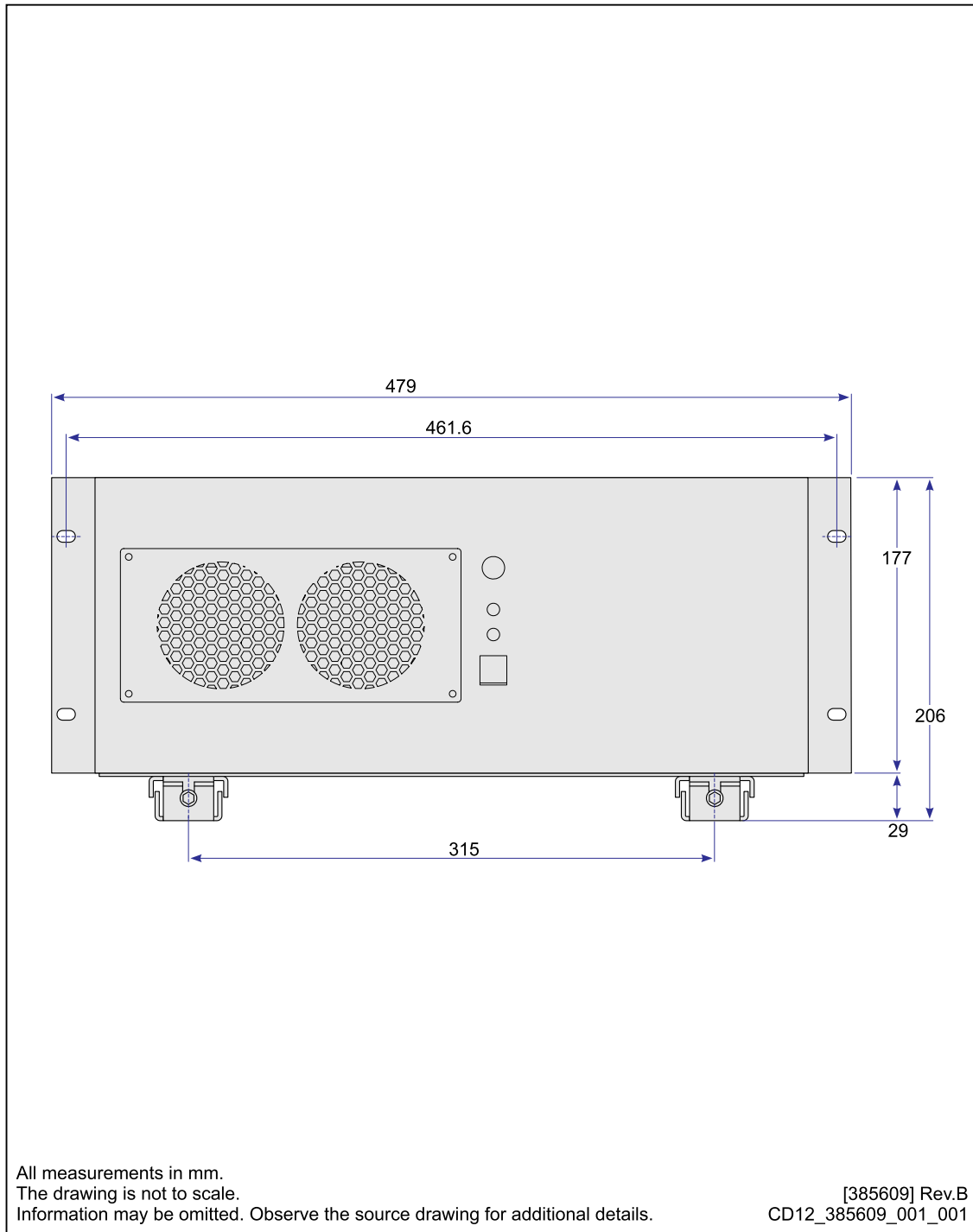



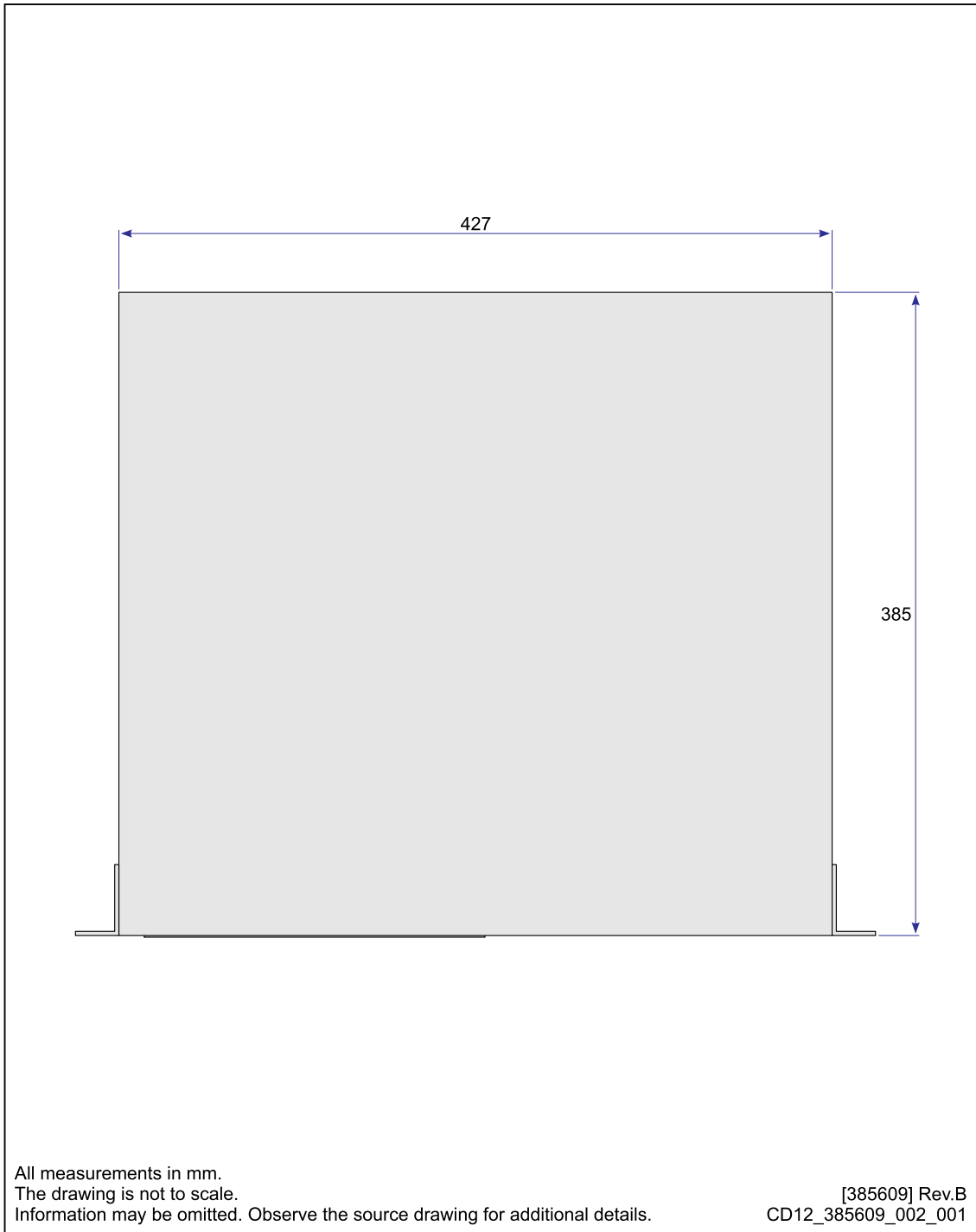

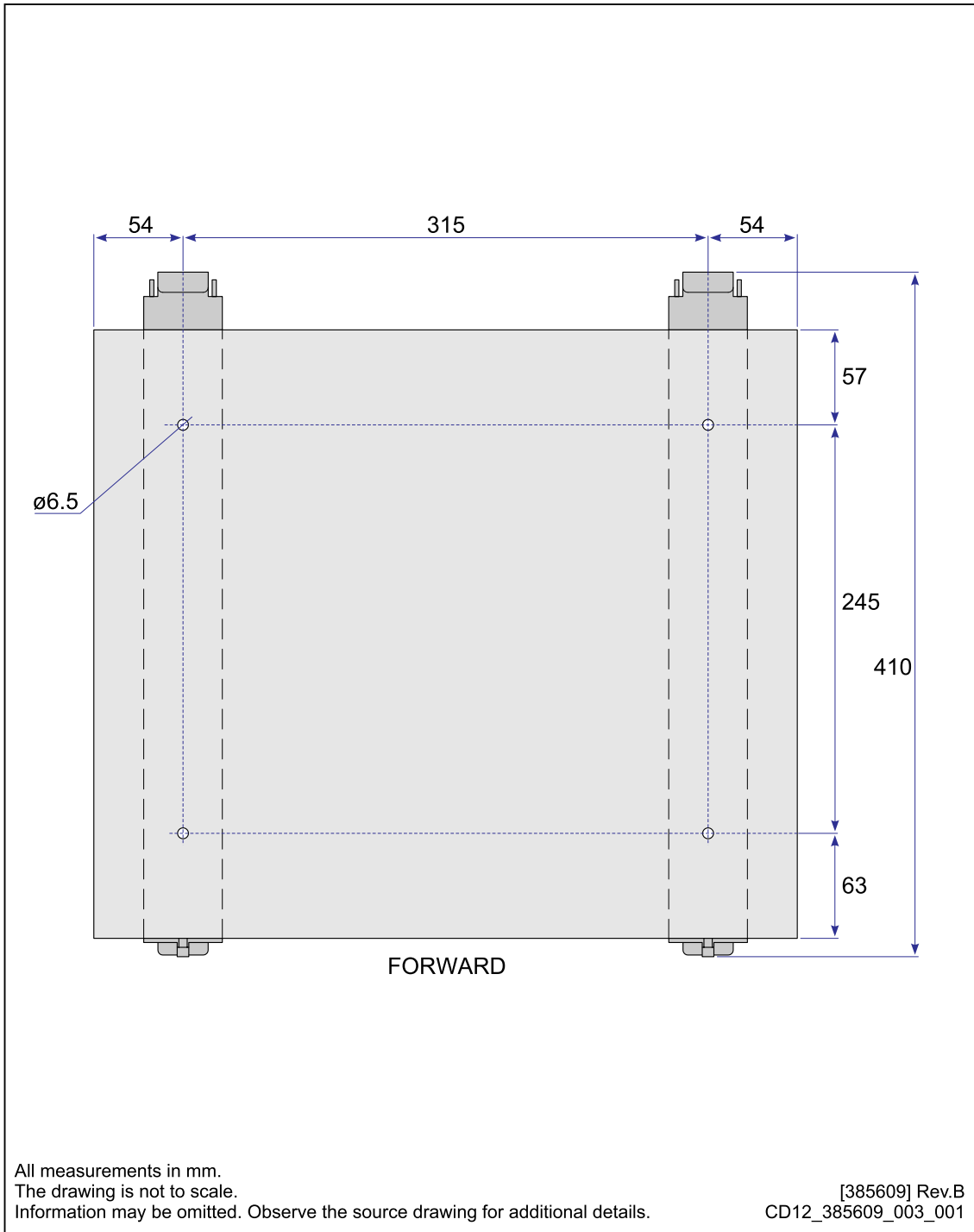

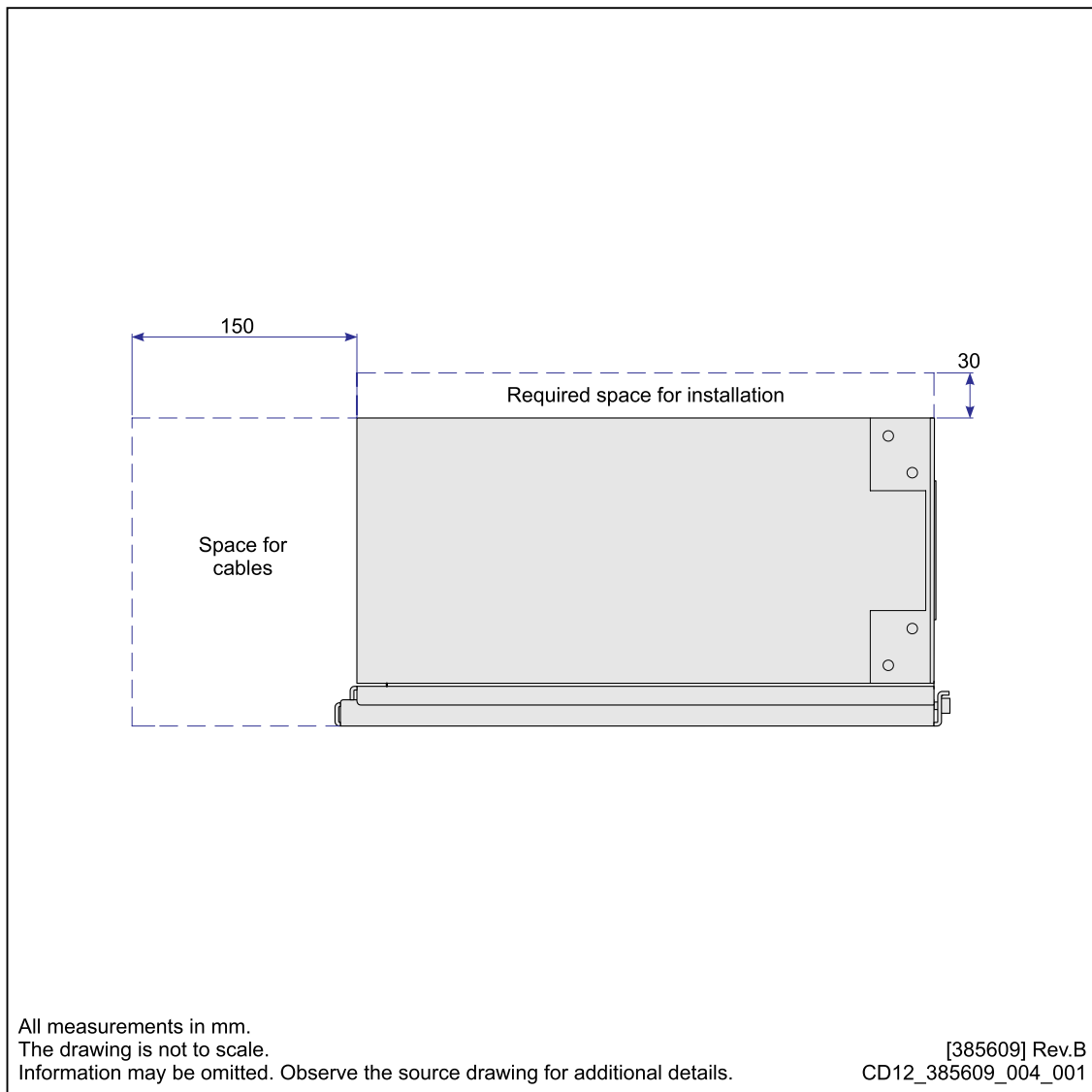

**Related topics**

[Drawing file, page 306](#)

[Simrad EK80, page 13](#)

[Installing the EK80 hardware units, page 64](#)

[Technical specifications, page 279](#)

## 400930 WBT Cabinet outline dimensions

Download the source drawing from the EK80 pages on <https://www.kongsberg.com/simrad>.

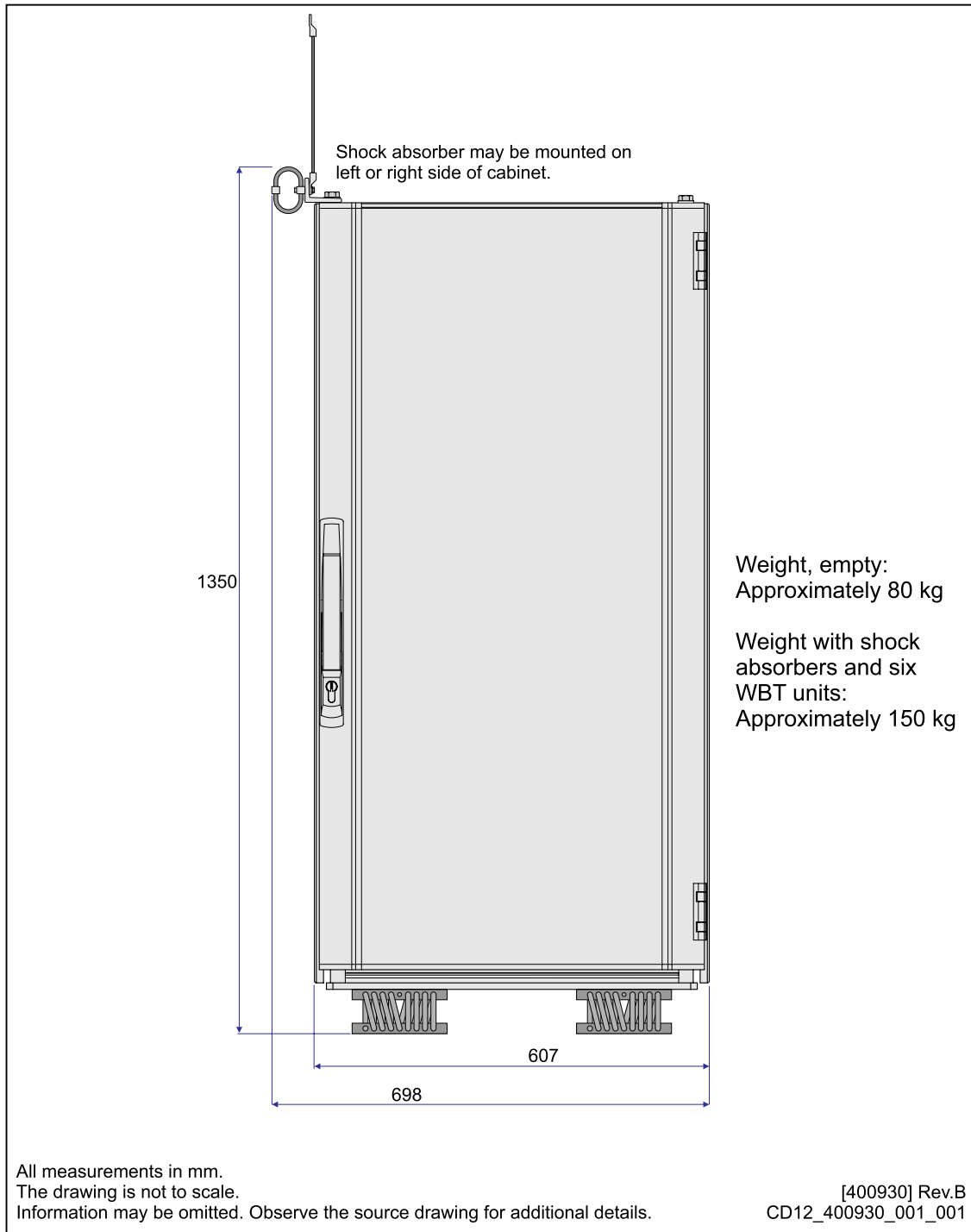

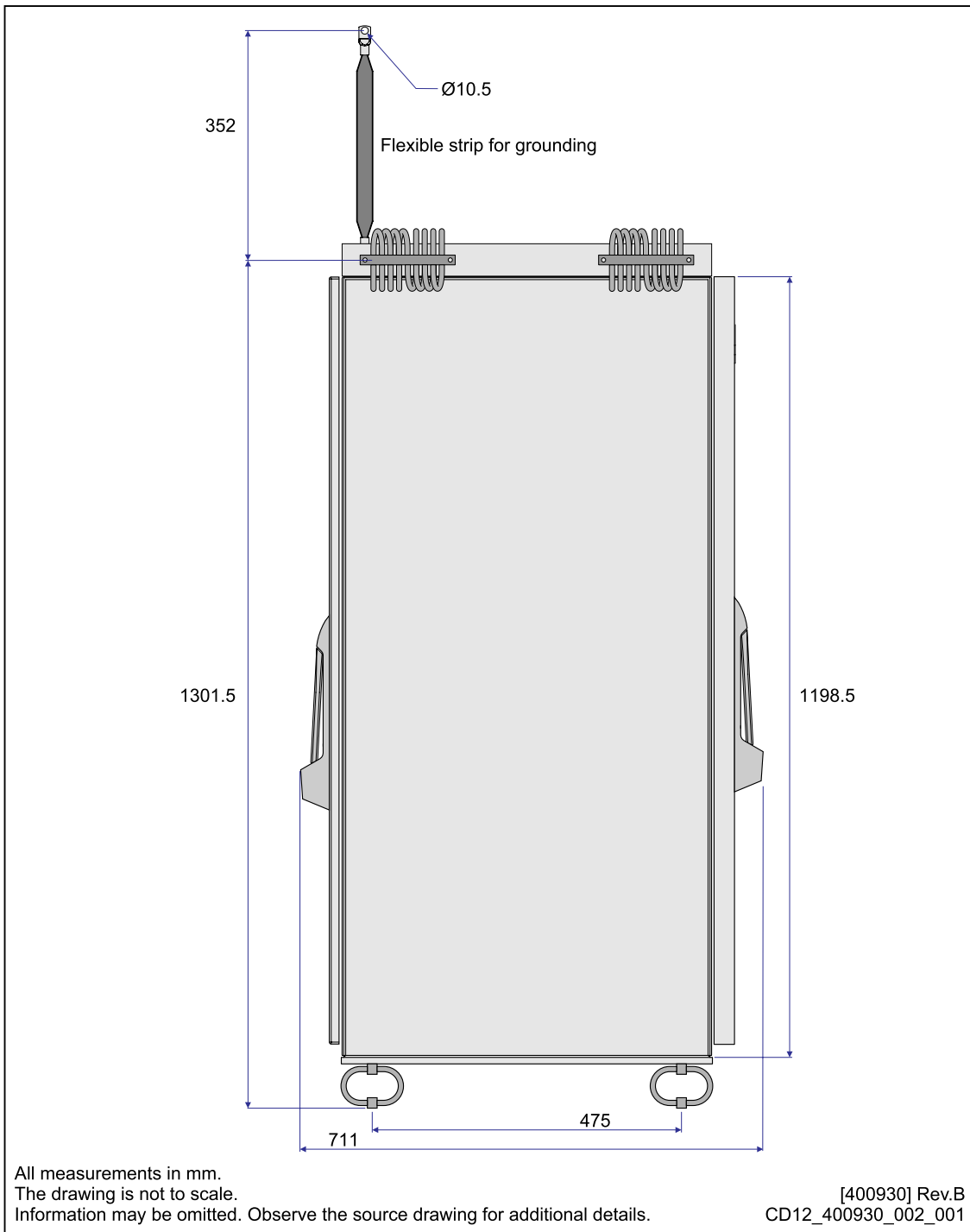

**Top view**

**Front**  
Provide minimum  
600 mm service area

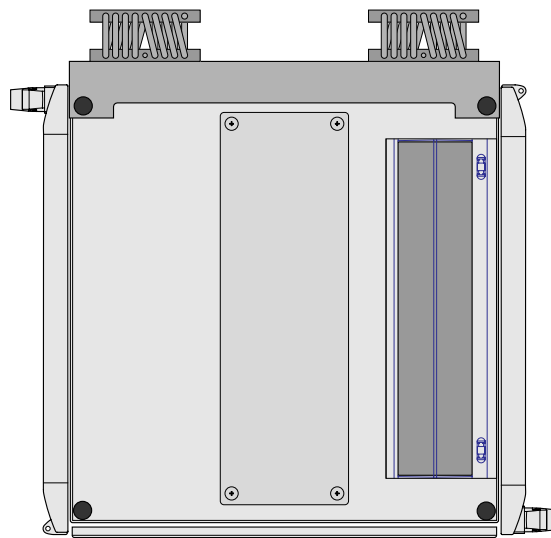

**Rear**  
Provide minimum  
600 mm service area

All measurements in mm.  
The drawing is not to scale.  
Information may be omitted. Observe the source drawing for additional details.

[400930] Rev.B  
CD12\_400930\_003\_001

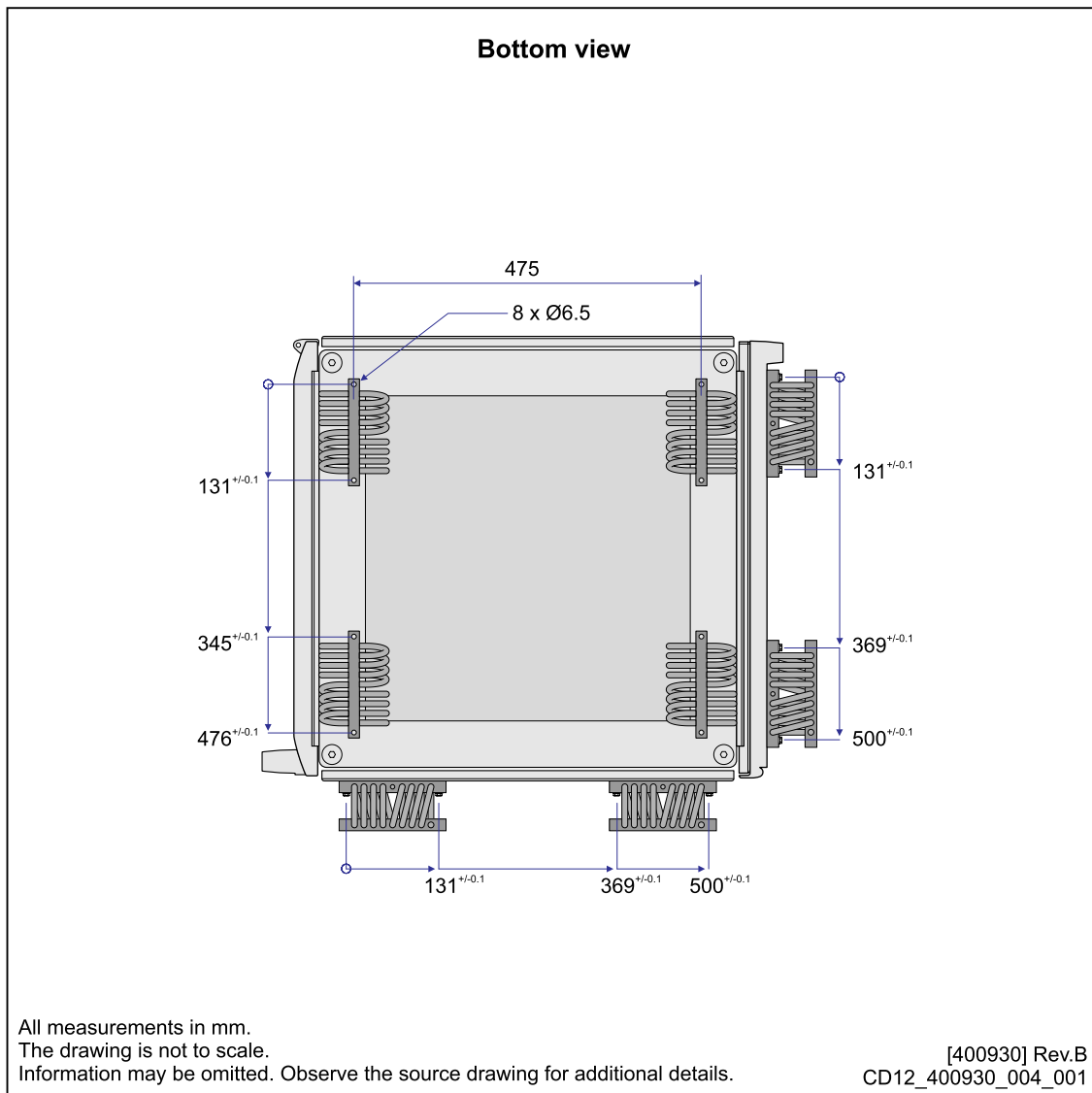

### Related topics

[Drawing file, page 306](#)

[Simrad EK80, page 13](#)

[Installing the EK80 hardware units, page 64](#)

[Technical specifications, page 279](#)

# 201575 Transducer connector assembly and wiring

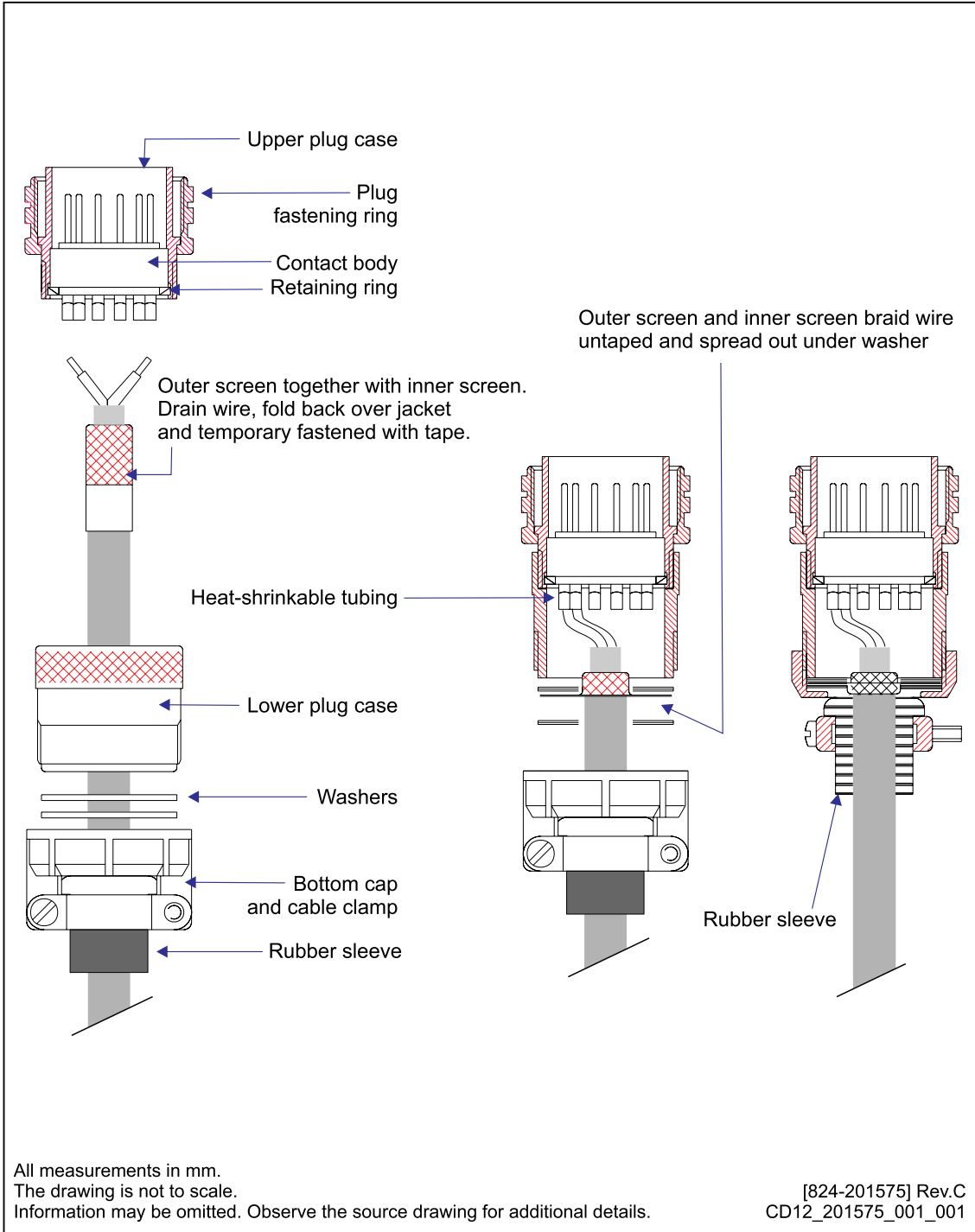



**Related topics**

[Drawing file, page 306](#)

[Simrad EK80, page 13](#)

[Installing the EK80 hardware units, page 64](#)

[Technical specifications, page 279](#)

# Equipment handling

Observe these basic rules for transportation, storage and handling of units. In this context, a *unit* may be any large or small part of the system. It can be supplied as part of the initial delivery, or as a spare part. The phrase *box* is used to describe all kinds of cases, wooden or cardboard boxes etc used to hold the *unit*.

## Topics

[Transporting Kongsberg Maritime equipment, page 321](#)

[Lifting units and transportation boxes, page 322](#)

[Inspection of units and transportation boxes after arrival, page 323](#)

[Specifications for storage prior to installation or use, page 324](#)

[Unpacking instructions, page 325](#)

[Specifications for storage after unpacking, page 330](#)

## Transporting Kongsberg Maritime equipment

Unless otherwise stated in the accompanying documentation, electronic, electromechanical and mechanical units supplied by Kongsberg Maritime can be only transported using methods approved for delicate and fragile equipment.

### Prerequisites

Transportation methods approved for delicate equipment includes transportation by road, rail, air or sea.

### Context

The units are to be transported in accordance with general or specific instructions for the appropriate unit(s), using pallets, transport cases, wooden boxes, or carton boxes as appropriate.

Observe the packing instructions.

### Note

---

*Special local restrictions concerning air transportation may be applied to units containing certain types of batteries. These units must be checked properly, and the regulations must be investigated by the packer/shipper before the unit is dispatched.*

---

### Procedure

- 1 Ensure that all local transportation is done according to the same specifications as for the initial delivery.
- 2 Make sure that the box containing the unit is kept dry at all times, and sheltered from the weather.

It must not be subjected to shocks, excessive vibration or other rough handling. The box will normally be marked with text or symbols indicating which way it is to be placed. Follow the instructions provided, and make sure that the box is always placed with its “top” facing upwards.

- 3 Make sure that the box is not used for any purpose for which it was not intended (step, table, etc.).

In the absence of other information, no other boxes must be stacked on top of it.

- 4 Handle all boxes and units with care.

### Note

---

*Due to the nature of Kongsberg Maritime’s products, and the extensive use of delicate electronic parts, all units and boxes must be regarded and handled as fragile equipment.*

---

## Lifting units and transportation boxes

Some of the boxes used to hold equipment units may be heavy. Use caution when lifting.

### Prerequisites

Units and boxes may be heavy. Make sure that you have the necessary equipment required for lifting heavy items. Persons using the lifting equipment must be skilled and have the relevant certificate(s).

### Context

A heavy box will normally be marked with its weight. The weights of other boxes in the shipment will normally be entered on the packing list(s).

Heavy units may be equipped with dedicated lifting lugs for transportation by crane within the workshop or installation area.

### Note

---

*Observe the local rules and regulations related to the use of lifting equipment.*

---

### Procedure

- 1 Check the weight of the box or unit before you attempt to lift it.
- 2 Make sure that you have the relevant lifting apparatus required, and that this equipment is approved and certified for the load.
- 3 If you need to use a crane:
  - a Check the applicable weight certificate for the crane.
  - b Check the security of the lifting lugs.
  - c If the unit to be lifted is provided with dedicated lifting lugs, make sure that all available lugs are used.
  - d Make sure that the unit remains under full control during the lifting operation.  
This is important to avoid damage to the unit, equipment or personnel.
- 4 If you need to use a forklift truck:
  - a Check the applicable weight certificate for the truck.
  - b Check the limitations for lifting height and angles.
  - c Pay special attention to the position of the unit's centre of gravity.
  - d Make sure that the unit is properly secured to the truck during the lifting and transportation operations.
- 5 Handle all units and boxes with care.

**Note**

*Due to the nature of Kongsberg Maritime's products, and the extensive use of delicate electronic parts, all units and boxes must be regarded and handled as fragile equipment.*

---

## Inspection of units and transportation boxes after arrival

A visual inspection must be done immediately after the box(es) have arrived at their destination.

**Prerequisites**

If you suspect that the equipment has been damaged during the transport, request that a representative of the carrier is present during the inspection.

**Procedure**

- 1 Check all boxes (wooden or cardboard boxes, plastic bags and/or pallets) for physical damage.  
Look for signs of dropping, immersion in water or other mishandling.
- 2 If external damage is detected, open the box to check its contents.  
Request that a representative of the carrier to be present while the box is opened, so any transportation damage can be identified and documented.
- 3 If a unit has been damaged, prepare an inspection report stating the condition of the unit and actions taken.  
Describe the damage, and collect photographic evidence if possible. Return the inspection report to Kongsberg Maritime as soon as possible.
- 4 If units are not damaged, check the humidity absorbing material.  
If required, dry or replace the bags, then re-pack the unit(s) according to the packing instructions.

## Specifications for storage prior to installation or use

When a system, a unit or a spare part has been delivered to the customer, it may be subject to long time storage prior to installation and use.

### General specifications

During this storage period, certain specifications must be met. The equipment must be preserved and stored in such a way that it does not constitute any danger to health, environment or personal injury.

- 1 The equipment must be stored in its original transportation box.
- 2 Ensure that the units are clearly separated in the shelves and that each unit is easily identifiable.
- 3 The box must not be used for any purpose for which it was not intended (work platform, steps, table etc.).
- 4 Boxes must not be placed on top of each other, unless specific markings permit this.
- 5 Boxes must not be placed directly on a dirt floor.
- 6 Do not open a box for inspection unless special circumstances permit so.  
“Special circumstances” may be suspected damage to the box and its content, or inspections by civil authorities.
  - a If a unit is damaged, prepare an inspection report stating the condition of the unit and the actions taken. Describe the damage and collect photographic evidence if possible. Re-preserve the equipment.
  - b If the unit is not damaged, check the humidity absorbing material. If required, dry or replace the bags, then re-pack the unit according to the packing instructions.
- 7 If a box has been opened, make sure that it is closed and sealed after the inspection. Use the original packing material as far as possible.
- 8 The storage room/area must be dry with a non-condensing atmosphere. It must be free from corrosive agents.
- 9 The storage room/area’s mean temperature must not be lower than  $-10^{\circ}\text{C}$ , and not warmer than  $+50^{\circ}\text{C}$ . If other limitations apply, the crates will be marked accordingly.
- 10 Boxes must not be exposed to moisture from fluid leakages.
- 11 Boxes must not be exposed to direct sunlight or excessive warmth from heaters.
- 12 Boxes must not be subjected to excessive shock and vibration.
- 13 If the unit contained in a box holds normal batteries, these may have been disconnected/isolated before the unit was packed. These must only be reconnected before the installation starts. Units containing batteries are marked.

### Caution

---

*Units containing lithium or alkaline batteries must be handled separately and with care. Such units are marked accordingly. Do not attempt to recharge such batteries, open them, or dispose of them by incineration.*

*Refer to the applicable product data sheets or battery handling procedures for further details.*

---

### Temperature protection

Any units that requires protection against extreme temperatures are identified as such in the applicable documentation. The box used to transport and store such units are clearly marked, for example:

**Must not be transported or stored in temperatures below -5 °C.**

Other temperature limits may be used if applicable.

If a unit needs temperature protection, the box to be used for storage and transportation must be lined on all walls, base and lid, using minimum 5 cm thick polyurethane or polystyrene foam.

Most system units can normally be stored in temperatures between -30° C and +70° C. Refer to the relevant technical specifications for details.

### Note

---

*Unless otherwise specified, transducers and hydrophones must not be stored in temperatures below -10°C and above +50°C.*

---

## Unpacking instructions

Prior to installation or use, electronic, electromechanical and mechanical units must be unpacked from their transport boxes. It is important that this unpacking is done according to the relevant instructions, and without inflicting damage to the equipment.

### Topics

[Unpacking standard parts and units, page 326](#)

[Unpacking mechanical units, page 327](#)

[Unpacking electronic and electromechanical units, page 328](#)

[Unpacking transducers, page 329](#)

## Unpacking standard parts and units

Prior to installation or use, parts and units must be inspected, and then unpacked from their transport boxes. It is important that this unpacking is done without inflicting damage to the equipment.

### Context

This procedure provides the basic tasks of unpacking units (main unit, spare parts etc) from boxes shipped from Kongsberg Maritime.

### Note

---

*If the unit in question is not unpacked for immediate use, you may consider storing it unopened in its original box. However, it may be useful to open the box to check its contents for damage and retrieve any accompanying documentation.*

*Do not use a knife to open cardboard boxes - the contents may be located close to the surface, and can then be damaged by the blade.*

---

### Procedure

- 1 Check the carton before opening it to ensure it shows no signs of dropping, immersion in water or other mishandling.
  - 1 If external damage is detected, open the box to check its contents.
  - 2 Request that a representative of the carrier to be present while the box is opened, so any transportation damage can be identified and documented.
  - 3 If a unit has been damaged, prepare an inspection report stating the condition of the unit and actions taken.

Describe the damage, and collect photographic evidence if possible. Return the inspection report to Kongsberg Maritime as soon as possible.
- 2 Place the box on a stable work bench or on the floor with the top of the box facing upwards.
- 3 In the absence of other instructions, always open the top of the carton first.

The contents of the box will normally have been lowered into the carton from above, so this will usually be the easiest route to follow. Be careful when you open the box, and make sure that the contents are not damaged. Do not use a knife to open cardboard boxes.
- 4 If the box has been closed using staples, remove the staples from the carton as you open it.

This will reduce the possibilities of scratch injury to yourself and damage to the contents.
- 5 If a wooden box has been closed using screws, always remove them using a screwdriver.

Do not attempt to force the lid open with a crowbar or similar tool.



- 6 Once the carton is open, carefully remove all loose packing and insulation material.
- 7 Check for user manuals and other documents that may have been added to the carton during packing.
- 8 Check also for special tools, door keys etc.

## Unpacking mechanical units

Prior to installation or use, mechanical units must be unpacked from their transport boxes. It is important that this unpacking is done without inflicting damage to the equipment.

### Prerequisites

Observe the procedure for unpacking of standard parts and units.

### Context

Mechanical and electromechanical units may be heavy.

A transducer must always be handled as a delicate instrument. Incorrect actions may damage the transducer beyond repair.

Observe these transducer handling rules:

- **Do not** activate the transducer when it is out of the water.
- **Do not** lift the transducer by the cable.
- **Do not** step on the transducer cable.
- **Do not** handle the transducer roughly. Avoid impacts.
- **Do not** expose the transducer to direct sunlight or excessive heat.
- **Do not** use high-pressure water, sandblasting, metal tools or strong solvents to clean the transducer face.

### Procedure

- 1 Obtain the necessary lifting equipment, and make sure that the equipment is certified for the weight.
- 2 Lift the unit out of the transportation box.
- 3 Place it in a stable position on the floor/work bench.
- 4 Inspect the unit for visual damage.
- 5 Remove any packing material that may be inside the unit.
- 6 Collect and keep the relevant user manuals and/or documents provided with the unit.

## Unpacking electronic and electromechanical units

Prior to installation or use, electronic and electromechanical units must be unpacked from their transport boxes. It is important that unpacking is done without inflicting damage to the equipment.

### Context

Electronic and electromechanical units are normally wrapped in clear antistatic plastic bags.

Do not break the seal to open a printed circuit board, an electronic module or a unit before it shall be used. If the unit is returned with a broken seal we will assume that it has been used. You will then be billed accordingly.

### Note

---

*Beware of Electrostatic Discharge (ESD)!*

*When you handle electronic circuit boards and modules, you must beware of the dangers of electrostatic discharge (ESD), both to yourself and to the equipment. In order to ensure safe transport and storage, circuit boards and other electronic units will always be wrapped in a clear plastic protective bag, and the bag will be sealed.*

---

### Procedure

- 1 Lift the unit, in its protective bag, out of the transport box.

#### Note

---

*You must never use the cables to lift or carry a unit.*

---

- 2 Place it in a stable position on the floor or on the workbench.
- 3 Inspect the unit for damage.
  - a If a unit has been damaged, prepare an inspection report stating the condition of the unit and actions taken.
  - b Describe the damage, and collect photographic evidence if possible. Return the inspection report to Kongsberg Maritime as soon as possible.
- 4 Assuming all is well, open the bag and remove the unit.
- 5 Take out and keep the documentation.

You will need the documentation if the item shall be returned to us.
- 6 If applicable, open the unit and check inside.
- 7 Remove any packing and desiccant material that may be found inside the shipping container or bag.
- 8 Collect and keep the relevant user manuals and/or installation documents provided with the unit.

## Unpacking transducers

Prior to installation or use, transducers, sonar heads and hydrophones must be unpacked from their transport boxes. It is important that this unpacking is done without inflicting damage to the equipment.

### Prerequisites

Observe the procedure for unpacking of standard parts and units.

### Context

Transducers may be supplied mounted to a hull unit (if any), or packed separately. Sonar heads and hydrophones are normally packed and shipped in separate boxes. Boxes are identified by the order number and the serial number of the unit inside.

### Note

---

*Once a transducer, sonar head or hydrophone is unpacked, make sure that the body and the cabling are not exposed to any mechanical stress. Protect the transducer face with a padded cover plate to prevent damage.*

---

Transducers may be heavy.

A transducer must always be handled as a delicate instrument. Incorrect actions may damage the transducer beyond repair.

Observe these transducer handling rules:

- **Do not** activate the transducer when it is out of the water.
- **Do not** lift the transducer by the cable.
- **Do not** step on the transducer cable.
- **Do not** handle the transducer roughly. Avoid impacts.
- **Do not** expose the transducer to direct sunlight or excessive heat.
- **Do not** use high-pressure water, sandblasting, metal tools or strong solvents to clean the transducer face.

### Procedure

- 1 Obtain the necessary lifting equipment, and make sure that the equipment is certified for the weight.
- 2 Lift the transducer, sonar head or hydrophone out of the transportation box.
- 3 Place it in a stable position on the floor/work bench.
- 4 Inspect the unit for visual damage.
- 5 Make sure that the relevant protection is kept in place until the final stages of the installation.
- 6 Collect and keep the relevant user manuals and/or documents provided with the unit.

- 7 Observe the handling rules for transducers.

## Specifications for storage after unpacking

The unit must whenever possible be stored in its original transportation crate until ready for installation.

### General specifications

During storage, each box must not be used for any purpose for which it was not intended (work platform, table, steps etc.).

Once unpacked, all equipment must be kept in a dry, non condensing atmosphere, free from corrosive agents and isolated from sources of vibration.

#### Note

---

*Do not break the seal to open a circuit board package before the board is to be used. If the board package is returned to Kongsberg Maritime with the seal broken, we will assume that the unit has been used, and then you will be billed accordingly.*

---

Each unit must be installed in its intended operating position as soon as possible after unpacking. If the unit contains normal batteries, these may have been disconnected/isolated before the unit was packed. These must then be reconnected during the installation procedure. Units containing batteries are marked.

#### Caution

---

*Units containing lithium or alkaline batteries must be handled separately and with care. Such units are marked accordingly. Do not attempt to recharge such batteries, open them, or dispose of them by incineration.*

*Refer to the applicable product data sheets or battery handling procedures for further details.*

---

### Temperature protection

Any units that requires protection against extreme temperatures are identified as such in the applicable documentation. The box used to transport and store such units are clearly marked, for example:

Must not be transported or stored in temperatures below -5 °C.

Other temperature limits may be used if applicable.

If a unit needs temperature protection, the box to be used for storage and transportation must be lined on all walls, base and lid, using minimum 5 cm thick polyurethane or polystyrene foam.

Most system units can normally be stored in temperatures between -30° C and +70° C. Refer to the relevant technical specifications for details.

Note

---

*Unless otherwise specified, transducers and hydrophones must not be stored in temperatures below  $-10^{\circ}\text{C}$  and above  $+50^{\circ}\text{C}$ .*

---

## Index

1000Base-T	
Ethernet cable .....	147
19" Transceiver Cabinet	
mounting .....	78
mounting the drawers .....	81
<b>A</b>	
about	
acoustic noise .....	54
ambient noise .....	58
bow thruster noise .....	51
Burton subsea connectors .....	162
cable conduit (for transducer cables) .....	105
cable glands .....	170
cavitation .....	48, 51, 57
comments .....	12
constructive criticism .....	12
document downloads .....	12
EC150-3C .....	23
electrical noise .....	56, 59
feedback .....	12
fishing gear noise .....	59
flow noise .....	48, 57
installation drawings .....	12, 307
installation instructions .....	11
interference .....	58
machinery noise .....	56
online information .....	12
propellers .....	51, 56
purpose of this manual .....	11
rattle noise .....	58
registered trademark SIMRAD .....	12
self noise .....	56
serial lines .....	164
steel conduit (for transducer cables) .....	105
suggestions .....	12
synchronization .....	126
target audience .....	11
transducer .....	23
AC mains	
tolerances .....	37
verifying that operational power is correct .....	188
ac mains power	
requirements .....	292
ac power	
cable .....	137
accuracy	
dimensional survey .....	181
accuracy requirements	
dimensional survey measurements of	
compass .....	181
dimensional survey measurements of course	
gyro .....	181
dimensional survey measurements of global	
positioning system .....	181
dimensional survey measurements of heading	
sensor .....	181
dimensional survey measurements of motion	
reference unit .....	181
dimensional survey measurements of	
transducer .....	181
acoustic noise	
about .....	54
ambient noise .....	58
bow thrusters .....	51
cavitation .....	48, 51, 57
contributing factors .....	54
electrical noise .....	56, 59
fishing gear noise .....	59
flow noise .....	48, 57
installation requirements .....	38
interference .....	58
machinery noise .....	56
propellers .....	51, 56
rattle noise .....	58
self noise .....	56
sources .....	54
ADCP-NetCDF	
file format .....	291
additional optional items	
not provided with the delivery .....	31
additional required items	
not provided with the delivery .....	27
adjusting	
the screen resolution .....	212
alternative origin	
vessel coordinate system .....	63, 183
ambient noise	
acoustic noise .....	58
AML	
datagram format .....	287
interface .....	244
annotation	
datagram format .....	281
annotation data	
datagram formats .....	281
annotations	
importing using a communication port .....	235
Annotations page	
importing annotations on a communication	
port .....	235
approval	
installation drawings .....	12, 46, 307
installation requirements .....	39
assembly	
transducer connector .....	318
Atlas Depth	
datagram format .....	290
ATS	
datagram format .....	281
audience	
this manual .....	11
auxiliary machinery	
acoustic noise .....	56
Auxiliary socket	
synchronization .....	129

- B**
- basic cable requirements ..... 167
  - basic items
    - provided with the delivery ..... 25
  - block
    - diagram ..... 17
  - book
    - purpose ..... 11
    - target audience ..... 11
  - BOT
    - file format ..... 291
  - bow thrusters
    - acoustic noise ..... 51
    - transducer installation ..... 51
  - bridge
    - cable plan ..... 89
  - brief description
    - transducer ..... 23
  - bulkhead
    - cable glands ..... 170
  - Burton subsea connectors
    - description ..... 162
- C**
- cabinet
    - WBT Cabinet outline dimensions ..... 314
  - cable
    - connecting the transducer cable to the
      - transceiver ..... 154, 156, 159
    - splicing the transducer cable ..... 107
  - cable conduit
    - minimum dimensions ..... 105
    - transducer cables ..... 105
  - cable connection
    - single beam low power transducer ..... 154
  - cable connections
    - requirements ..... 169
  - cable drawing
    - ac power cable ..... 137
    - dc power cable ..... 148
    - Ethernet cable RJ45 ..... 147
    - Moxa CP114EL-I serial adapter ..... 114, 145
    - RS-232 serial line ..... 140–141
    - RS-422 serial line ..... 142
    - RS-485 serial line ..... 144
    - serial line used for synchronisation ..... 143
    - vessel ground ..... 139
  - cable gland
    - preparing cable for termination ..... 171
  - cable glands
    - about ..... 170
    - procedures ..... 170
  - cable grounding
    - requirements ..... 169
  - cable identification
    - requirements ..... 170
  - cable installation
    - prerequisites ..... 97
  - cable plan
    - bridge ..... 89
    - computer ..... 89
    - topside ..... 89, 93
    - transceiver ..... 90–92
  - Wide Band Transceiver (WBT) ..... 90–92
  - cable requirements
    - cable ..... 167
    - cable connections ..... 169
    - cable terminations ..... 169
    - cable trays ..... 167
    - grounding ..... 169
    - identification ..... 170
    - physical protection ..... 168
    - radio frequency interference ..... 168
  - cable sealing
    - multi-diameter ..... 174
  - cable specifications
    - RS-232 ..... 140–141
    - RS-422 ..... 142
    - serial line used for synchronization ..... 143
  - cable terminations
    - requirements ..... 169
  - cable trays
    - requirements ..... 167
  - cables
    - about cable glands ..... 170
    - connection requirements ..... 169
    - grounding requirements ..... 169
    - identification requirements ..... 170
    - installation requirements ..... 38
    - list of system interconnection cables ..... 94
    - preparing for termination ..... 171
    - procedures for cable glands ..... 170
    - protection ..... 168
    - protection of transducer cables ..... 105
    - read this first ..... 86
    - requirements for cable trays ..... 167
    - requirements for physical protection ..... 168
    - requirements for radio frequency
      - interference ..... 168
    - securing and terminating ..... 173
    - termination requirements ..... 169
    - transducer cable in steel conduit ..... 105
    - using multi-diameter cable sealing ..... 174
  - CAT5
    - Ethernet cable ..... 147
  - CAT5E
    - Ethernet cable ..... 147
  - catch monitoring information
    - datagram formats ..... 286
  - catch sensor
    - setting up the interface ..... 237
  - cavitation
    - acoustic noise ..... 48, 51, 57
    - transducer ..... 51
  - channels
    - installing transceiver channels ..... 210
  - classification society
    - approval ..... 39
    - approval of installation drawings ..... 12, 46, 307
  - Clear To Send
    - used in synchronization ..... 143
  - Clear To Send (CTS)
    - synchronization using Clear To Send (CTS)
      - and Request To Send (RTS) signals ..... 129
  - colour display
    - required item ..... 27
  - comments
    - importing using a communication port ..... 235

send us.....	12	weight .....	295
commercial computer		conduit (steel)	
installation .....	72	minimum dimensions .....	105
communication formats		transducer cables.....	105
annotation data .....	281	conduits	
catch monitoring information .....	286	cable requirements.....	167
depth information .....	283	configuring	
distance information.....	282	sensor interface.....	234
drop keel information .....	282	connect	
GPS information .....	283	transducer cable to the transceiver.....	154, 156, 159
gyro information .....	284	connection	
heading information .....	284	Ethernet cable .....	147
motion information .....	285	RS-232 serial cable .....	140–141
palette control .....	286	RS-422 serial cable .....	142
position information .....	283	RS-485 serial cable .....	144
processed data to file .....	290	serial line used for synchronisation.....	143
processed data to output .....	289	single beam low power transducer .....	154
sound speed information .....	287	connections	
speed information.....	288	ac power cable .....	137
temperature information .....	288	cable requirements.....	169
trawl information .....	284	dc power cable .....	148
water level .....	289	Moxa CP114EL-I serial adapter .....	114, 145
communication port		Øverland UPC-3005 Serial line splitter.....	120
setting up the parameters .....	230	Øverland UPC-5000P Serial line splitter.....	124
compass		vessel ground cable.....	139
accuracy requirements for dimensional survey		connectors	
measurements.....	181	computer .....	102
interface requirements.....	33	Processor Unit.....	102
optional item.....	33	transceiver .....	104
recommended item .....	33	constructive criticism	
scope of supply.....	33	send us.....	12
compass deviation		contributing factors	
installation requirements.....	38	acoustic noise.....	54
responsibility .....	38	coordinate system	
compass safe distance		alternative origin .....	63, 183
computer .....	301	origin .....	62, 183
display.....	301	vessel .....	61, 182
Ethernet switch.....	302	course gyro	
power supply .....	302	accuracy requirements for dimensional survey	
Processor Unit.....	301	measurements.....	181
technical specifications.....	301	interface requirements.....	33
transceiver .....	301	optional item.....	33
Transceiver Unit .....	301	recommended item .....	33
WBT Cabinet.....	302	scope of supply.....	33
Wide Band Transceiver (WBT).....	301	verifying the interface .....	263
competence		CP1	
requirements for installation personnel .....	47	datagram format.....	290
computer		CP114EL-I	
adjusting the screen resolution .....	212	serial adapter .....	114, 145
cable plan .....	89	creating	
compass safe distance .....	301	installation drawings .....	12, 46, 307
connectors.....	102	mounting procedures .....	12, 46, 307
environmental requirements.....	298	CSD (compass safe distance)	
graphic adapter .....	112	computer .....	301
installation .....	72, 74	display .....	301
introduction .....	20	Ethernet switch.....	302
minimum requirements .....	303	power supply .....	302
outline dimensions .....	295	Processor Unit.....	301
outline dimensions drawing .....	310	technical specifications.....	301
overview .....	20	transceiver .....	301
power requirements.....	292	Transceiver Unit .....	301
purpose .....	20	WBT Cabinet.....	302
required item .....	28	Wide Band Transceiver (WBT).....	301
scope of supply.....	28	CTS	
visual inspection .....	192		



- synchronization using Clear To Send (CTS)  
and Request To Send (RTS) signals ..... 129
- CTS (Clear to Send)  
used in synchronization ..... 143
- CTS (Clear To Send)  
interface ..... 151  
synchronization ..... 148, 151
- CUR  
datagram format ..... 288
- D**
- (D)GPS  
interface requirements ..... 32  
optional item ..... 32  
recommended item ..... 32  
scope of supply ..... 32
- data  
defining the file and folder preferences for data  
recording ..... 226
- datagram format  
AML (sound speed) ..... 287  
annotation ..... 281  
Atlas Depth (depth information) ..... 290  
ATS ..... 281  
CPI (Current Profile) ..... 290  
CUR (multi-layer water current data) ..... 288  
DBS (depth from surface) ..... 289  
DBS (depth of the trawl sensor) ..... 284  
DBT (depth under transducer) ..... 289  
DDC (display dimming and control) ..... 286  
DFT (Water Level) ..... 289  
DPT (depth under transducer,  
offset) ..... 283, 289  
EM Attitude 3000 (motion data) ..... 285  
Furuno GPhve (heave information) ..... 286  
GGA (time, position and fix) ..... 283  
GGK (global positioning system fixed data) ..... 283  
GLL (time, position and fix) ..... 283  
HDG (heading) ..... 284  
HDM (heading) ..... 284  
HDT (true heading) ..... 284  
Hemisphere GNSS GPHEV (heave  
information) ..... 286  
HFB (trawl heights) ..... 285  
KM Binary (motion data) ..... 285  
MTW (water temperature) ..... 288  
OFS Drop keel ..... 282  
PSIMPD (catch sensor data) ..... 286  
PSIMPD1 (catch sensor data) ..... 287  
PSIMPF (catch sensor data) ..... 287  
PTNL GGK (time, position) ..... 283  
RMC (time, date, position, course) ..... 283  
Simrad PSIMDHB (biomass and bottom  
hardness) ..... 290  
TDS (trawl door distance) ..... 285  
THS (true heading) ..... 284  
TPR (trawl bearing, depth and distance) ..... 285  
TPT (trawl bearing, depth and distance) ..... 285  
TSS1 (motion data) ..... 286  
VBW (vessel speed) ..... 288, 290  
VHW (vessel heading and speed) ..... 288, 290  
VLW (travelled distance) ..... 282  
VTG (time, date, position and  
course) ..... 283, 288, 290
- ZDA (day, month, year and local time zone) ..... 283  
ZMQ (Beam velocity) ..... 289
- datagram formats  
annotation data ..... 281  
catch monitoring information ..... 286  
depth information ..... 283  
distance information ..... 282  
drop keel information ..... 282  
gyro information ..... 284  
heading information ..... 284  
motion information ..... 285  
palette control ..... 286  
position information ..... 283  
processed data to file ..... 290  
processed data to output ..... 289  
sound speed information ..... 287  
speed information ..... 288  
temperature information ..... 288  
trawl information ..... 284  
water level ..... 289
- DBS  
datagram format ..... 284, 289
- DBT  
datagram format ..... 289
- dc power  
cable ..... 148
- DDC  
datagram format ..... 286
- define  
file and folder preferences for data  
recording ..... 226
- depth  
setting up depth output ..... 245
- depth information  
datagram formats ..... 283
- Depth Output page  
setting up depth output ..... 245
- description  
ambient noise ..... 58  
boundary water layer ..... 50  
bow thruster noise ..... 51  
Burton subsea connectors ..... 162  
cable conduit (for transducer cables) ..... 105  
cavitation ..... 48, 51, 57  
display ..... 19  
EC150-3C ..... 23  
electrical noise ..... 56, 59  
fishing gear noise ..... 59  
flow noise ..... 48, 57  
interference ..... 58  
machinery noise ..... 56  
origin in the vessel coordinate system ..... 62, 183  
Øverland UPC-3005 Serial line splitter ..... 118  
Øverland UPC-5000P Serial line splitter ..... 122  
propellers ..... 51, 56  
rattle noise ..... 58  
self noise ..... 56  
steel conduit (for transducer cables) ..... 105  
system ..... 15  
transceiver ..... 21  
Transceiver Unit ..... 21  
transducer ..... 23  
vessel coordinate system ..... 61, 182  
Wide Band Transceiver (WBT) ..... 21
- DFT

datagram format.....	289	Ethernet cable RJ45 .....	147
dimensional survey		Moxa CP114EL-I serial adapter .....	114, 145
accuracy.....	181	Øverland UPC-3005 Serial line splitter.....	121
accuracy requirements for compass .....	181	Øverland UPC-5000P Serial line splitter .....	125
accuracy requirements for course gyro .....	181	Processor Unit outline dimensions .....	310
accuracy requirements for global positioning		RS-232 serial line cable.....	140–141
system.....	181	RS-422 serial line cable.....	142
accuracy requirements for heading sensor.....	181	RS-485 serial line cable.....	144
accuracy requirements for motion reference		serial line used for synchronisation.....	143
unit .....	181	system diagram.....	17
accuracy requirements for transducer.....	181	transducer connector .....	318
summary procedure.....	179	vessel ground.....	139
dimensions		WBT Cabinet outline dimensions .....	314
about.....	307	Wide Band Transceiver (WBT) outline	
computer .....	295	dimensions .....	308
computer outline dimensions drawing .....	310	drawings	
display.....	295	about.....	307
download.....	46	approval.....	12, 46, 307
Ethernet switch.....	296	creating.....	12, 46, 307
Øverland UPC-3005 Serial line splitter.....	121	download.....	46
Øverland UPC-5000P Serial line splitter .....	125	installation .....	12
Processor Unit.....	295	responsibility .....	12, 46, 307
Processor Unit outline dimensions drawing.....	310	Drop keel	
steel conduit .....	105	datagram format.....	282
technical specifications.....	295	drop keel information	
transceiver .....	296	datagram formats .....	282
WBT Cabinet.....	297, 314	dry docking	
Wide Band Transceiver (WBT).....	296, 308	installation requirements.....	39
display			
compass safe distance .....	301	<b>E</b>	
description .....	19	EC150-3C	
environmental requirements.....	298	description .....	23
installation .....	71, 76	EC150-3C Power Supply Unit	
introduction.....	19	visual inspection .....	197
minimum requirements .....	304	electrical connections	
outline dimensions.....	295	Øverland UPC-3005 Serial line splitter.....	120
overview .....	19	Øverland UPC-5000P Serial line splitter .....	124
power requirements.....	292	electrical noise	
purpose .....	19	acoustic noise.....	56, 59
required item .....	27	electromechanical unit	
scope of supply.....	27	unpacking .....	328
visual inspection .....	190	electronic unit	
weight .....	295	unpacking .....	328
display adapter		EM Attitude 3000	
computer graphic adapter.....	112	datagram format .....	285
Processor Unit graphic adapter .....	112	Enix	
display unit		installation .....	74
required item .....	27	environmental	
distance information		requirements.....	298
datagram formats .....	282	environmental requirements	
docking		computer .....	298
important reminder .....	14	display.....	298
installation requirements.....	39	Ethernet switch.....	299
documents		Processor Unit.....	298
download from website .....	12	transceiver .....	299
download		Transceiver Unit .....	299
documents from website .....	12	Wide Band Transceiver (WBT).....	299
installation drawings .....	46	equipment handling	
www.simrad.com .....	12	inspection .....	323
DPT		lifting units and transportation boxes .....	322
datagram format.....	283, 289	storage after unpacking .....	330
drawing		storage prior to installation .....	324
ac power cable.....	137	transportation.....	321
computer outline dimensions.....	310	unpacking .....	326
dc power cable .....	148		

- unpacking a hydrophone ..... 329
  - unpacking a mechanical unit ..... 327
  - unpacking a sonar head ..... 329
  - unpacking a transducer ..... 329
  - unpacking an electronic or electromechanical unit ..... 328
  - visual inspection ..... 323
  - Ethernet cable
    - specifications ..... 147
  - Ethernet interface
    - network adapter ..... 205
  - Ethernet port
    - defining the communication port parameters ..... 230
  - Ethernet switch
    - compass safe distance ..... 302
    - environmental requirements ..... 299
    - introduction ..... 21
    - outline dimensions ..... 296
    - overview ..... 21
    - power requirements ..... 293
    - purpose ..... 21
    - required item ..... 29
    - scope of supply ..... 29
    - weight ..... 296
  - exporting
    - motion sensor data ..... 248
    - navigation data ..... 248
- F**
- failures
    - support if something breaks down ..... 14
  - feedback
    - send us ..... 12
  - file format
    - ADCP-NetCDF ..... 291
    - BOT ..... 291
    - NetCDF ..... 291
    - XYZ ..... 289–290
  - file formats
    - processed data to file ..... 290
    - processed data to output ..... 289
  - file locations
    - file and folder preferences for data recording ..... 226
  - file setup
    - file and folder preferences for data recording ..... 226
  - fishing gear noise
    - acoustic noise ..... 59
  - flow noise
    - acoustic noise ..... 48, 57
    - protruding objects ..... 49
  - folder locations
    - file and folder preferences for data recording ..... 226
  - formats
    - processed data to file ..... 290
    - processed data to output ..... 289
  - functional
    - diagram ..... 17
  - Furuno GPhve
    - datagram format ..... 286
- G**
- general requirements
    - supply power ..... 37
  - general safety rules ..... 36
  - GGA
    - datagram format ..... 283
  - GGK
    - datagram format ..... 283
  - GLL
    - datagram format ..... 283
  - global positioning system
    - accuracy requirements for dimensional survey measurements ..... 181
    - interface requirements ..... 32
    - optional item ..... 32
    - recommended item ..... 32
    - scope of supply ..... 32
  - global positioning system (GPS)
    - setting up the interface ..... 232
    - verifying the interface ..... 265
  - GPHEV
    - datagram format ..... 286
  - GPhve
    - datagram format ..... 286
  - GPS
    - accuracy requirements for dimensional survey measurements ..... 181
    - interface requirements ..... 32
    - optional item ..... 32
    - recommended item ..... 32
    - scope of supply ..... 32
    - setting up the interface ..... 232
    - verifying the interface ..... 265
  - GPS information
    - datagram formats ..... 283
  - graphic adapter
    - adjusting screen resolution ..... 212
    - computer ..... 112
    - Processor Unit ..... 112
  - ground
    - cable ..... 139
  - grounding
    - cable requirements ..... 169
  - gyro
    - verifying the interface ..... 263
  - gyro information
    - datagram formats ..... 284
- H**
- handling
    - transducers ..... 15
  - HDG
    - datagram format ..... 284
  - HDM
    - datagram format ..... 284
  - HDT
    - datagram format ..... 284
  - heading gyro
    - verifying the interface ..... 263
  - heading information
    - datagram formats ..... 284
  - heading sensor

accuracy requirements for dimensional survey	
measurements.....	181
interface requirements.....	33
optional item.....	33
recommended item.....	33
scope of supply.....	33
help	
support offices.....	41
Hemisphere GNSS GPHEV	
datagram format.....	286
HFB	
datagram format.....	285
high voltage	
safety rules.....	36
how to	
adjust the screen resolution.....	212
configure the sensor interface.....	234
connect the transducer cable to the	
transceiver.....	154, 156, 159
define the Ethernet (LAN) port parameters.....	230
define the file and folder preferences for data	
recording.....	226
define the serial port parameters.....	230
do a dimensional survey.....	179
do a visual inspection of the computer.....	192
do a visual inspection of the display.....	190
do a visual inspection of the EC150-3C Power	
Supply Unit.....	197
do a visual inspection of the Power Supply	
Unit.....	197
do a visual inspection of the Processor Unit.....	192
do a visual inspection of the transceiver.....	193
do a visual inspection of the Transceiver	
Unit.....	193
do a visual inspection of the WBT Cabinet.....	195
export motion sensor data to peripheral	
systems.....	248
export navigation data to peripheral	
systems.....	248
import annotations on a communication	
port.....	235
install a commercial computer.....	72
install navigation and other sensors	
(summary).....	228
install one or more transducers (in user	
interface).....	206
install the computer.....	74
install the display.....	71, 76
install the Enix.....	74
install the operational software.....	201
install the power supply.....	69
install the Processor Unit.....	74
install the software license.....	203
install the transceiver.....	65, 67
install the Transceiver Unit.....	65, 67
install the Wide Band Transceiver	
(WBT).....	65, 67
install transceiver channels.....	210
interface a sound speed sensor.....	244
lift units and transportation boxes.....	322
make a noise/speed curve to determine vessel	
noise.....	273
measure noise in passive mode.....	259
mount the drawers in the WBT Cabinet.....	81
mount the WBT Cabinet.....	78
obtain and install the software license.....	203
prepare a cable for termination.....	171
secure and terminate a cable.....	173
select measurement units.....	225
select menu language.....	224
set to work.....	186
set up (summary).....	199
set up depth output.....	245
set up synchronization.....	131, 249
set up the catch sensor interface.....	237
set up the GPS interface.....	232
set up the motion reference unit (MRU)	
interface.....	241
set up the navigation sensor interface.....	232
set up the serial ports on the adapter.....	116
set up the trawl system interface.....	239
splice the transducer cable.....	107
synchronise using Auxiliary port.....	134, 252
transport Kongsberg Maritime equipment.....	321
troubleshoot time zone settings.....	222
turn off.....	276
turn on.....	202
unpack a hydrophone.....	329
unpack a mechanical unit.....	327
unpack a sonar head.....	329
unpack a transducer.....	329
unpack an electronic or electromechanical	
unit.....	328
unpack standard parts and units.....	326
use multi-diameter cable sealing.....	174
verify that operational power is correct.....	188
verify the communication with the motion	
reference unit (MRU).....	269
verify the course gyro interface.....	263
verify the GPS interface.....	265
verify the gyro interface.....	263
verify the heading gyro interface.....	263
verify the navigation sensor interface.....	265
verify the speed log interface.....	267
visual inspection of units and transportation	
boxes after arrival.....	323
How to	
install Network Time Protocol.....	214
install Network Time Protocol monitor.....	218
hull surface	
protruding objects.....	49
humidity	
requirements.....	298
hydrophone	
unpacking.....	329
<b>I</b>	
I/O Setup page	
connecting a catch monitoring system.....	237
connecting a trawl system.....	239
importing annotations on a communication	
port.....	235
identification	
cable requirements.....	170
IEC	
line socket.....	137
illustration	
system diagram.....	17
import	

- annotations ..... 235
- important
  - before you power up ..... 14
  - if something breaks down ..... 14
  - power off ..... 14
  - reminders ..... 14
  - switch off ..... 14
  - transducer handling ..... 15
  - when not in use ..... 14
  - when you are docking your vessel ..... 14
- information
  - high voltage ..... 36
  - online ..... 12
  - support ..... 41
- initial
  - setup (summary) ..... 199
- inspection
  - transportation boxes ..... 323
  - units ..... 323
  - visual inspection of the computer ..... 192
  - visual inspection of the display ..... 190
  - visual inspection of the EC150-3C Power Supply Unit ..... 197
  - visual inspection of the Power Supply Unit ..... 197
  - visual inspection of the Processor Unit ..... 192
  - visual inspection of the transceiver ..... 193
  - visual inspection of the Transceiver Unit ..... 193
  - visual inspection of the WBT Cabinet ..... 195
- Install
  - Network Time Protocol ..... 214
  - Network Time Protocol monitor ..... 218
- install transducer
  - in forward part of hull ..... 50
- installation
  - computer ..... 72, 74
  - display ..... 71, 76
  - drawings ..... 12
  - Enix ..... 74
  - instructions ..... 11
  - overview ..... 44
  - power supply ..... 69
  - Processor Unit ..... 74
  - requirements for installation personnel ..... 47
  - software ..... 201
  - summary ..... 44
  - summary of transducer installation ..... 83
  - tasks ..... 44
  - transceiver ..... 65, 67
  - transceiver channels ..... 210
  - Transceiver Unit ..... 65, 67
  - transducer (in user interface) ..... 206
  - Wide Band Transceiver (WBT) ..... 65, 67
- installation approval
  - installation requirements ..... 39
- installation drawings
  - about ..... 307
  - approval ..... 12, 46, 307
  - creating ..... 12, 46, 307
  - download ..... 46
- installation of cables
  - prerequisites ..... 97
- installation requirements
  - approval by classification society ..... 39
  - cables and wiring ..... 38
  - compass deviation ..... 38
  - dry docking ..... 39
  - environmental ..... 298
  - humidity ..... 298
  - noise sources ..... 38
  - temperature ..... 298
  - uninterruptible power supply ..... 37
- installing
  - WBT Cabinet ..... 78
  - WBT Cabinet drawers ..... 81
- instructions
  - installation ..... 11
  - unpacking ..... 325
- interconnection cables
  - list ..... 94
- interface
  - motion reference unit (MRU) setup ..... 241
  - setting up depth output ..... 245
  - setting up GPS interface ..... 232
  - setting up navigation sensor interface ..... 232
  - setting up the catch sensor interface ..... 237
  - setting up the motion reference unit (MRU) interface ..... 241
  - setting up the serial ports on the adapter ..... 116
  - setting up the trawl system interface ..... 239
  - sound speed sensor ..... 244
  - using RS-232 serial line ..... 151
  - verifying motion reference unit (MRU) interface ..... 269
  - verifying the course gyro interface ..... 263
  - verifying the GPS interface ..... 265
  - verifying the gyro interface ..... 263
  - verifying the heading gyro interface ..... 263
  - verifying the navigation sensor interface ..... 265
  - verifying the speed log interface ..... 267
- interface requirements
  - compass ..... 33
  - course gyro ..... 33
  - heading sensor ..... 33
  - motion reference unit (MRU) ..... 30, 34
  - speed log ..... 33
- interfaces
  - computer ..... 102
  - Øverland UPC-3005 Serial line splitter ..... 120
  - Øverland UPC-5000P Serial line splitter ..... 124
  - Processor Unit ..... 102
  - transceiver ..... 104
  - Wide Band Transceiver (WBT) software ..... 104
- interfacing a navigation sensor
  - Sensor Installation page ..... 232
  - summary ..... 228
- interference
  - acoustic noise ..... 58
  - cable requirements ..... 168
  - electrical noise ..... 56, 59
- internet
  - network security ..... 40
- introduction
  - computer ..... 20
  - display ..... 19
  - Ethernet switch ..... 21
  - Processor Unit ..... 20
  - transceiver ..... 21
  - Transceiver Unit ..... 21
  - WBT Mini ..... 22
  - WBT Tube ..... 22

Wide Band Transceiver (WBT).....	21	purpose.....	11
IP address		target audience.....	11
network adapter.....	205	maritime authority	
IP Address		approval of installation drawings.....	12, 46, 307
network adapter.....	205	master	
<b>J</b>		setting up synchronization.....	131, 249
junction box		synchronization mode.....	127
splicing the transducer cable.....	107	measurement units	
<b>K</b>		selecting.....	225
K-Sync		measuring	
synchronization using RS-232 serial line.....	148	noise in passive mode.....	259
KM Binary		mechanical drawings	
datagram format.....	285	about.....	307
Kongsberg EM Attitude 3000		download.....	46
datagram format.....	285	mechanical unit	
Kongsberg Maritime		unpacking.....	327
support.....	41	menu language	
<b>L</b>		select.....	224
LAN port		minimize effect	
defining the communication port		boundary water layer.....	50
parameters.....	230	minimum dimensions	
language		steel conduit.....	105
select.....	224	minimum requirements	
LCD display		computer.....	303
required item.....	27	display.....	304
LCD monitor		steel conduit.....	105
environmental requirements.....	298	uninterruptible power supply.....	35
installation.....	71, 76	mode	
minimum requirements.....	304	synchronization.....	127
outline dimensions.....	295	monitor	
power requirements.....	292	environmental requirements.....	298
weight.....	295	installation.....	71, 76
lifting		minimum requirements.....	304
transportation boxes.....	322	outline dimensions.....	295
unit.....	322	power requirements.....	292
line socket		weight.....	295
IEC.....	137	motion information	
list		datagram formats.....	285
system interconnection cables.....	94	motion reference unit	
logo		accuracy requirements for dimensional survey	
registered trademark.....	12	measurements.....	181
low power		datagram formats.....	285
transducer connection.....	154	exporting motion data on a communication	
<b>M</b>		port.....	248
machinery noise		motion reference unit (MRU)	
acoustic noise.....	56	interface requirements.....	30, 34
main engine		optional item.....	33
acoustic noise.....	56	required item.....	29
main items		scope of supply.....	29, 33
provided with the delivery.....	25	setting up the interface.....	241
mains power		verifying interface.....	269
cable.....	137	verifying the communication.....	269
requirements.....	292	Motion Reference Unit (MRU) page	
tolerances.....	37	interfacing a motion sensor.....	241
verifying that operational power is correct.....	188	motion sensor	
manual		exporting motion data on a communication	
		port.....	248
		mounting	
		WBT Cabinet.....	78
		WBT Cabinet drawers.....	81
		mounting procedures	
		creating.....	12, 46, 307
		responsibility.....	12, 46, 307
		Moxa	
		serial adapter.....	114, 145

- 
- MRU
    - accuracy requirements for dimensional survey measurements ..... 181
    - datagram formats ..... 285
    - exporting motion data on a communication port ..... 248
    - interface requirements ..... 30, 34
    - scope of supply ..... 29, 33
    - setting up the interface ..... 241
    - verifying interface ..... 269
    - verifying the communication ..... 269
  - MTW
    - datagram format ..... 288
  - multi-diameter cable sealing
    - using ..... 174
  - N**
  - navigation
    - exporting navigation data on a communication port ..... 248
  - navigation sensor
    - installing navigation and other sensors (summary) ..... 228
    - setting up the interface ..... 232
    - verifying the interface ..... 265
  - NetCDF
    - file format ..... 291
  - network adapter
    - IP Address ..... 205
    - IP address for transceiver communication ..... 205
    - Subnet mask ..... 205
  - network security ..... 40
  - Network Time Protocol
    - installation ..... 214
  - Network Time Protocol monitor
    - installation ..... 218
  - NMEA
    - RS-485 serial cable ..... 144
  - NMEA CUR
    - datagram format ..... 288
  - NMEA datagram
    - CUR (multi-layer water current data) ..... 288
    - DBS (depth from surface) ..... 289
    - DBT (depth under transducer) ..... 289
    - DDC (display dimming and control) ..... 286
    - DPT (depth under transducer, offset) ..... 283, 289
    - GGA (time, position and fix) ..... 283
    - GGK (global positioning system fixed data) ..... 283
    - GLL (time, position and fix) ..... 283
    - HDG (heading) ..... 284
    - HDM (heading) ..... 284
    - HDT (true heading) ..... 284
    - MTW (water temperature) ..... 288
    - RMC (time, date, position, course) ..... 283
    - THS (true heading) ..... 284
    - VBW (vessel speed) ..... 288, 290
    - VHW (vessel heading and speed) ..... 288, 290
    - VLW (travelled distance) ..... 282
    - VTG (time, date, position and course) ..... 283, 288, 290
    - ZDA (day, month, year and local time zone) ..... 283
  - NMEA datagrams
    - gyro information ..... 284
    - heading information ..... 284
  - NMEA DBS
    - datagram format ..... 289
  - NMEA DBT
    - datagram format ..... 289
  - NMEA DDC
    - datagram format ..... 286
  - NMEA DPT
    - datagram format ..... 283, 289
  - NMEA GGA
    - datagram format ..... 283
  - NMEA GGK
    - datagram format ..... 283
  - NMEA GLL
    - datagram format ..... 283
  - NMEA HDG
    - datagram format ..... 284
  - NMEA HDM
    - datagram format ..... 284
  - NMEA HDT
    - datagram format ..... 284
  - NMEA MTW
    - datagram format ..... 288
  - NMEA RMC
    - datagram format ..... 283
  - NMEA THS
    - datagram format ..... 284
  - NMEA VBW
    - datagram format ..... 288, 290
  - NMEA VHW
    - datagram format ..... 288, 290
  - NMEA VLW
    - datagram format ..... 282
  - NMEA VTG
    - datagram format ..... 283, 288, 290
  - NMEA ZDA
    - datagram format ..... 283
  - noise
    - about acoustic noise ..... 54
    - ambient noise ..... 58
    - bow thruster noise ..... 51
    - cavitation ..... 48, 51, 57
    - contributing factors ..... 54
    - electrical noise ..... 56, 59
    - fishing gear noise ..... 59
    - flow noise ..... 48, 57
    - interference ..... 58
    - machinery noise ..... 56
    - making a noise/speed curve to determine vessel noise ..... 273
    - measuring ..... 259
    - propeller noise ..... 51, 56
    - rattle noise ..... 58
    - self noise ..... 56
  - noise sources ..... 54
    - installation requirements ..... 38
  - noise/speed curve
    - making ..... 273
  - none
    - synchronization mode ..... 127
  - note
    - before you power up ..... 14
    - important reminders ..... 14
    - support if something breaks down ..... 14
    - when the system not in use ..... 14

when you are docking your vessel.....	14	connections .....	120
when you wish to switch off .....	14	description .....	118
<b>O</b>		outline dimensions drawing .....	121
off		technical specifications.....	119
turn.....	276	<b>Øverland UPC-5000P</b>	
offices		connections .....	124
support .....	41	description .....	122
OFS		outline dimensions drawing .....	125
datagram format.....	282	technical specifications.....	123
on		overview	
turn.....	202	computer .....	20
online		display.....	19
information .....	12	Ethernet switch.....	21
operating humidity		installation tasks .....	44
WBT Cabinet.....	299	Processor Unit.....	20
operating temperature		transceiver .....	21
WBT Cabinet.....	299	Transceiver Unit .....	21
operating voltage		transducer installation.....	83
computer .....	292	WBT Mini .....	22
display.....	292	WBT Tube .....	22
Ethernet switch.....	293	Wide Band Transceiver (WBT).....	21
power supply .....	293		
Processor Unit.....	292	<b>P</b>	
transceiver .....	293	palette control	
Transceiver Unit .....	293	datagram formats .....	286
WBT Cabinet.....	294	passive mode	
Wide Band Transceiver (WBT).....	293	measuring noise.....	259
operational power		PC	
verify .....	188	installation .....	74
operational software		performance requirements	
installation .....	201	uninterruptible power supply.....	35
optional item		personnel skills	
compass .....	33	requirements for installation.....	47
course gyro .....	33	physical protection	
global positioning system.....	32	cable requirements.....	168
heading sensor.....	33	plug	
motion reference unit (MRU) .....	33	transducer connector assembly.....	318
serial line splitter.....	34	plugs	
speed log .....	33	computer .....	102
uninterruptible power supply.....	35	Processor Unit.....	102
optional items		transceiver .....	104
not provided with the delivery .....	31	Wide Band Transceiver (WBT).....	104
origin		position information	
vessel coordinate system.....	62, 183	datagram formats .....	283
outline dimensions		power	
about.....	307	requirements .....	292
computer .....	295	power consumption	
display.....	295	computer .....	292
download.....	46	Ethernet switch.....	293
Ethernet switch.....	296	Processor Unit.....	292
Processor Unit.....	295	transceiver .....	293
technical specifications.....	295	Transceiver Unit .....	293
transceiver .....	296	WBT Cabinet.....	294
WBT Cabinet.....	297, 314	Wide Band Transceiver (WBT).....	293
Wide Band Transceiver (WBT).....	296, 308	power mains	
outline dimensions drawing		tolerances .....	37
computer .....	310	power off	
Øverland UPC-3005 Serial line splitter.....	121	important reminder .....	14
Øverland UPC-5000P Serial line splitter.....	125	power requirements	
Processor Unit.....	310	computer .....	292
output		display.....	292
setting up depth output.....	245	Ethernet switch.....	293
Øverland UPC-3005		power supply .....	293
		Processor Unit.....	292



- transceiver ..... 293
- Transceiver Unit ..... 293
- WBT Cabinet ..... 294
- Wide Band Transceiver (WBT) ..... 293
- power supply
  - compass safe distance ..... 302
  - installation ..... 69
  - power requirements ..... 293
  - verifying that operational power is correct ..... 188
- Power Supply Unit
  - visual inspection ..... 197
- power up
  - important reminder ..... 14
- preferences
  - defining the file and folder preferences for raw data recording ..... 226
- prerequisites
  - cable installation ..... 97
- presentation
  - adjusting the screen resolution ..... 212
- problem
  - support if something breaks down ..... 14
- procedure
  - adjusting the screen resolution ..... 212
  - configuring the sensor interface ..... 234
  - connecting the transducer cable to the transceiver ..... 154, 156, 159
  - defining the Ethernet (LAN) port parameters ..... 230
  - defining the file and folder preferences for data recording ..... 226
  - defining the serial port parameters ..... 230
  - doing a dimensional survey ..... 179
  - exporting motion sensor data to peripheral systems ..... 248
  - exporting navigation data to peripheral systems ..... 248
  - importing annotations on a communication port ..... 235
  - installing a commercial computer ..... 72
  - installing navigation and other sensors (summary) ..... 228
  - installing one or more transducers (in user interface) ..... 206
  - installing the computer ..... 74
  - installing the display ..... 71, 76
  - installing the Enix ..... 74
  - installing the operational software ..... 201
  - installing the Processor Unit ..... 74
  - installing the software license ..... 203
  - installing the transceiver ..... 65, 67
  - installing the Transceiver Unit ..... 65, 67
  - installing the Wide Band Transceiver (WBT) ..... 65, 67
  - installing transceiver channels ..... 210
  - interfacing a sound speed sensor ..... 244
  - lifting units and transportation boxes ..... 322
  - making a noise/speed curve to determine vessel noise ..... 273
  - measuring noise in passive mode ..... 259
  - mounting the drawers in the WBT Cabinet ..... 81
  - mounting the WBT Cabinet ..... 78
  - obtaining and installing the software license ..... 203
  - power supply installation ..... 69
  - preparing a cable for termination ..... 171
  - securing and terminating a cable ..... 173
  - selecting measurement units ..... 225
  - selecting menu language ..... 224
  - setting to work ..... 186
  - setting up depth output ..... 245
  - setting up summary ..... 199
  - setting up synchronization ..... 131, 249
  - setting up the catch sensor interface ..... 237
  - setting up the GPS interface ..... 232
  - setting up the motion reference unit (MRU) interface ..... 241
  - setting up the navigation sensor interface ..... 232
  - setting up the serial ports on the adapter ..... 116
  - setting up the trawl system interface ..... 239
  - splicing the transducer cable ..... 107
  - synchronisation using Auxiliary port ..... 134, 252
  - transporting Kongsberg Maritime equipment ..... 321
  - turning off ..... 276
  - turning on ..... 202
  - unpacking a hydrophone ..... 329
  - unpacking a mechanical unit ..... 327
  - unpacking a sonar head ..... 329
  - unpacking a transducer ..... 329
  - unpacking an electronic or electromechanical unit ..... 328
  - unpacking standard parts and units ..... 326
  - using multi-diameter cable sealing ..... 174
  - verifying that operational power is correct ..... 188
  - verifying the communication with the motion reference unit (MRU) ..... 269
  - verifying the course gyro interface ..... 263
  - verifying the GPS interface ..... 265
  - verifying the gyro interface ..... 263
  - verifying the heading gyro interface ..... 263
  - verifying the navigation sensor interface ..... 265
  - verifying the speed log interface ..... 267
  - visual inspection of the computer ..... 192
  - visual inspection of the display ..... 190
  - visual inspection of the EC150-3C Power Supply Unit ..... 197
  - visual inspection of the Power Supply Unit ..... 197
  - visual inspection of the Processor Unit ..... 192
  - visual inspection of the transceiver ..... 193
  - visual inspection of the Transceiver Unit ..... 193
  - visual inspection of the WBT Cabinet ..... 195
  - visual inspection of units and transportation boxes after arrival ..... 323
  - procedures
    - creating mounting procedures ..... 12, 46, 307
    - unpacking ..... 325
  - Processor Unit
    - adjusting the screen resolution ..... 212
    - compass safe distance ..... 301
    - connectors ..... 102
    - environmental requirements ..... 298
    - graphic adapter ..... 112
    - installation ..... 74
    - introduction ..... 20
    - outline dimensions ..... 295
    - outline dimensions drawing ..... 310
    - overview ..... 20
    - power requirements ..... 292

purpose .....	20	defining the file and folder preferences for data recording.....	226
required item .....	28	recording	
scope of supply.....	28	defining the file and folder preferences for raw data recording.....	226
visual inspection .....	192	reminder	
weight .....	295	before you power up.....	14
propellers		important.....	14
acoustic noise.....	51, 56	support if something breaks down.....	14
transducer installation.....	51	when the system not in use.....	14
proprietary datagram		when you are docking your vessel.....	14
AML (sound speed) .....	287	when you wish to switch off .....	14
Atlas Depth (depth information).....	290	Request To Send	
Simrad PSIMDHB (biomass and bottom hardness).....	290	used in synchronization .....	143
proprietary datagrams		Request To Send (RTS)	
annotation data .....	281	synchronization using Clear To Send (CTS) and Request To Send (RTS) signals .....	129
protection		required item	
cable requirements.....	168	computer .....	28
transducer cables in steel conduit.....	105	display .....	27
protruding objects		Ethernet switch.....	29
avoid.....	49	motion reference unit (MRU).....	29
PSIMDHB		Processor Unit.....	28
datagram format.....	290	transducer .....	28
PSIMPD		required items	
datagram format.....	286	not provided with the delivery .....	27
PSIMPD1		requirement	
datagram format.....	287	skills of installation personnel .....	47
PSIMPF		requirements	
datagram format.....	287	ac mains power.....	292
PTNL GGK		approval by classification society.....	39
datagram format.....	283	cable connections .....	169
publication		cable grounding .....	169
purpose .....	11	cable identification.....	170
target audience .....	11	cable terminations .....	169
purpose		cable trays.....	167
computer .....	20	cables and wiring .....	38, 167
display .....	19	cheading sensor .....	33
Ethernet switch.....	21	compass .....	33
Processor Unit.....	20	compass deviation .....	38
this manual.....	11	computer .....	303
transceiver .....	21	course gyro .....	33
Transceiver Unit .....	21	dimensional survey measurements of compass.....	181
WBT Mini .....	22	dimensional survey measurements of course gyro.....	181
WBT Tube .....	22	dimensional survey measurements of global positioning system .....	181
Wide Band Transceiver (WBT).....	21	dimensional survey measurements of heading sensor .....	181
purse seine		dimensional survey measurements of motion reference unit .....	181
fishing gear noise .....	59	dimensional survey measurements of transducer.....	181
<b>R</b>		display.....	304
radio frequency interference		dry docking .....	39
cable requirements.....	168	environmental .....	298
rattle noise		global positioning system interface .....	32
acoustic noise.....	58	humidity.....	298
raw data		mains power .....	292
recording preferences .....	226	motion reference unit (MRU) interface.....	30, 34
reader		noise sources .....	38
this manual.....	11	physical protection of cables .....	168
recommended item		power .....	292
compass .....	33		
course gyro .....	33		
global positioning system.....	32		
heading sensor.....	33		
speed log .....	33		
uninterruptible power supply.....	35		
record			

- radio frequency interference ..... 168
  - speed log interface ..... 33
  - steel conduit ..... 105
  - supply power ..... 37, 292
  - temperature ..... 298
  - uninterruptible power supply ..... 35, 37
  - responsibility
    - compass deviation ..... 38
    - installation drawings ..... 12, 46, 307
    - mounting procedures ..... 12, 46, 307
  - RF interference
    - cable requirements ..... 168
  - RJ45
    - Ethernet cable ..... 147
  - RMC
    - datagram format ..... 283
  - Roxtec
    - multi-diameter cable sealing ..... 174
  - RS-232
    - about ..... 164
    - cable specifications ..... 140–141
    - interface ..... 151
    - Moxa CP114EL-I serial adapter ..... 114, 145
    - serial line cable ..... 140–141
    - synchronization ..... 148, 151
  - RS-422
    - Moxa CP114EL-I serial adapter ..... 114, 145
    - serial line cable ..... 142
  - RS-422e
    - about ..... 164
  - RS-485
    - about ..... 164
    - Moxa CP114EL-I serial adapter ..... 114, 145
    - serial line cable ..... 144
  - RTS
    - synchronization using Clear To Send (CTS) and Request To Send (RTS) signals ..... 129
  - RTS (Request to Send)
    - used in synchronization ..... 143
  - RTS (Request To Send)
    - interface ..... 151
    - synchronization ..... 148, 151
  - rules
    - safety ..... 36
    - transducer handling ..... 15
- S**
- safety rules ..... 36
  - scope of supply
    - basic items ..... 25
    - compass ..... 33
    - computer ..... 28
    - course gyro ..... 33
    - display ..... 27
    - Ethernet switch ..... 29
    - global positioning system ..... 32
    - heading sensor ..... 33
    - motion reference unit (MRU) ..... 29, 33
    - optional items not provided with the delivery ..... 31
    - Processor Unit ..... 28
    - required items not provided with the delivery ..... 27
    - serial line splitter ..... 34
    - speed log ..... 33
    - transducer ..... 28
    - uninterruptible power supply ..... 35
  - screen resolution
    - adjusting ..... 212
  - securing
    - cable ..... 173
  - security
    - network ..... 40
  - selecting
    - measurement units ..... 225
  - self noise
    - acoustic noise ..... 56
  - sensor
    - configuring ..... 234
  - Sensor Configuration page
    - configuring the sensor interface ..... 234
  - Sensor Installation page
    - installing navigation and other sensors (summary) ..... 228
    - interfacing a navigation sensor ..... 232
  - serial adapter
    - Moxa CP114EL-I ..... 114, 145
    - setting up the serial ports on the adapter ..... 116
  - serial interface
    - setting up the serial ports on the adapter ..... 116
  - serial line
    - about ..... 164
    - cable specifications serial line used for synchronization ..... 143
    - Moxa CP114EL-I serial adapter ..... 114, 145
    - RS-232 cable specifications ..... 140–141
    - RS-422 cable specifications ..... 142
    - RS-485 cable specifications ..... 144
  - serial line splitter
    - connections ..... 120, 124
    - optional item ..... 34
    - Øverland UPC-3005 description ..... 118
    - Øverland UPC-3005 technical specifications ..... 119
    - Øverland UPC-5000P description ..... 122
    - Øverland UPC-5000P technical specifications ..... 123
    - scope of supply ..... 34
  - serial line used for synchronization
    - cable specifications ..... 143
  - serial port
    - defining the communication port parameters ..... 230
    - setting up the serial ports on the adapter ..... 116
  - setting to work
    - procedures ..... 186
  - setting up
    - the trawl system interface ..... 239
  - setup
    - initial summary ..... 199
    - select menu language ..... 224
  - shipyard cables
    - description ..... 86
  - Simrad
    - registered trademark ..... 12
    - support ..... 41
  - SIMRAD
    - registered trademark ..... 12
  - Simrad DBS
    - datagram format ..... 284
  - Simrad HFB

datagram format.....	285	technical.....	280
Simrad PSIMDHB		vessel ground cable.....	139
datagram format.....	290	weight.....	295
Simrad PSIMPD		speed information	
datagram format.....	286	datagram formats.....	288
Simrad PSIMPD1		speed log	
datagram format.....	287	interface requirements.....	33
Simrad PSIMPF		optional item.....	33
datagram format.....	287	recommended item.....	33
Simrad TDS		scope of supply.....	33
datagram format.....	285	verifying the interface.....	267
Simrad TPR		splicing	
datagram format.....	285	transducer cable.....	107
Simrad TPT		standalone	
datagram format.....	285	synchronization mode.....	127
single beam		standard computer	
transducer connection.....	154	installation.....	72
size		standard items	
computer.....	295	provided with the delivery.....	25
display.....	295	standards	
Ethernet switch.....	296	serial line.....	164
Processor Unit.....	295	steel conduit	
technical specifications.....	295	minimum dimensions.....	105
transceiver.....	296	transducer cables.....	105
WBT Cabinet.....	297	storage	
Wide Band Transceiver (WBT).....	296	after unpacking.....	330
skills		prior to installation.....	324
requirements for installation personnel.....	47	storage temperature	
slamming		WBT Cabinet.....	299
transducer.....	49	Subnet mask	
slave		network adapter.....	205
setting up synchronization.....	131, 249	suggestions	
synchronization mode.....	127	send us.....	12
sockets		summary	
computer.....	102	dimensional survey procedure.....	179
Processor Unit.....	102	installation.....	44
transceiver.....	104	transducer installation.....	83
Wide Band Transceiver (WBT).....	104	supply power	
software		requirements.....	292
installation.....	201	tolerances.....	37
software license		supply voltage	
installing.....	203	computer.....	292
obtaining.....	203	display.....	292
sonar head		Ethernet switch.....	293
unpacking.....	329	power supply.....	293
sound speed		Processor Unit.....	292
AML datagram format.....	287	transceiver.....	293
sound speed information		Transceiver Unit.....	293
datagram formats.....	287	WBT Cabinet.....	294
sound speed sensor		Wide Band Transceiver (WBT).....	293
interface.....	244	support	
specifications		if something breaks down.....	14
ac power cable.....	137	support information.....	41
compass safe distance.....	301	surface	
dc power cable.....	148	protruding objects.....	49
Ethernet cable RJ45.....	147	survey	
outline dimensions.....	295	dimensional survey accuracy.....	181
Øverland UPC-3005 Serial line splitter.....	119	summary procedure for dimensional survey.....	179
Øverland UPC-5000P Serial line splitter.....	123	survey requirements	
RS-232 serial line cable.....	140–141	accuracy requirements for dimensional survey	
RS-422 serial line cable.....	142	measurements of compass.....	181
RS-485 serial line cable.....	144	accuracy requirements for dimensional survey	
serial line used for synchronization.....	143	measurements of course gyro.....	181
storage after unpacking.....	330		
storage prior to installation.....	324		

accuracy requirements for dimensional survey measurements of global positioning system.....	181
accuracy requirements for dimensional survey measurements of heading sensor.....	181
accuracy requirements for dimensional survey measurements of motion reference unit.....	181
accuracy requirements for dimensional survey measurements of transducer.....	181
switch	
off.....	276
on.....	202
switch off	
important reminder.....	14
synchronisation	
serial line used for synchronisation.....	143
WBT Auxiliary port.....	134, 252
synchronization	
about.....	126
setting up.....	131, 249
specifications serial line.....	143
using Clear To Send (CTS) and Request To Send (RTS) signals.....	129
using RS-232 serial line.....	148, 151
using transceiver Auxiliary socket.....	129
synchronization mode	
description.....	127
system	
description.....	15
diagram.....	17
system cables	
description.....	86
list.....	94
system not in use	
important reminder.....	14
system setup	
initial (summary).....	199
system software	
installation.....	201
<b>T</b>	
target audience	
this manual.....	11
TDS	
datagram format.....	285
technical	
specifications.....	280
technical requirements	
ac mains power.....	292
computer.....	303
display.....	304
mains power.....	292
power.....	292
supply power.....	292
uninterruptible power supply.....	35
technical specifications	
compass safe distance.....	301
outline dimensions.....	295
Øverland UPC-3005 Serial line splitter.....	119
Øverland UPC-5000P Serial line splitter.....	123
weight.....	295
technical support	
offices.....	41
Teledyne TSS1	
datagram format.....	286
temperature requirements.....	298
temperature information	
datagram formats.....	288
termination	
cable.....	173
preparing cable.....	171
terminations	
cable requirements.....	169
this manual	
purpose.....	11
target audience.....	11
THS	
datagram format.....	284
time zone settings	
troubleshoot.....	222
tolerances	
supply power.....	37
topside	
cable plan.....	89, 93
TPR	
datagram format.....	285
TPT	
datagram format.....	285
transceiver	
cable plan.....	90–92
compass safe distance.....	301
connecting the transducer cable.....	154, 156, 159
connectors.....	104
description.....	21
environmental requirements.....	299
installation.....	65, 67
installing transceiver channels.....	210
introduction.....	21
outline dimensions.....	296
overview.....	21
power requirements.....	293
purpose.....	21
visual inspection.....	193
weight.....	296
transceiver Auxiliary socket	
synchronization.....	129
Transceiver Cabinet	
mounting.....	78
mounting the drawers.....	81
transceiver channels	
installing.....	210
Transceiver Installation page	
installing transceiver channels.....	210
Transceiver Unit	
compass safe distance.....	301
description.....	21
environmental requirements.....	299
installation.....	65, 67
introduction.....	21
overview.....	21
power requirements.....	293
purpose.....	21
visual inspection.....	193
transducer	
accuracy requirements for dimensional survey measurements.....	181
bow thrusters.....	51

brief description	23	standard parts and units	326
cavitation	51	UPC-3005	
installation summary	83	connections	120
propellers	51	description	118
required item	28	outline dimensions drawing	121
scope of supply	28	technical specifications	119
slamming	49	UPC-5000P	
unpacking	329	connections	124
user interface installation	206	description	122
transducer cable		outline dimensions drawing	125
connecting the transducer cable to the		technical specifications	123
transceiver	154, 156, 159	UPS	
splicing	107	installation requirements	37
transducer cables		minimum requirements	35
protection in steel conduit	105	optional item	35
steel conduit	105	recommended item	35
transducer connection		scope of supply	35
single beam low power	154	user interface	
transducer connector		select language	224
assembly and wiring	318		
transducer EC150-3C		<b>V</b>	
description	23	VBW	
transducer handling		datagram format	288, 290
important rules	15	verifying	
Transducer Installation page		motion reference unit (MRU) interfaces	269
installing one or more transducers	206	vessel coordinate system	
transportation		alternative origin	63, 183
of delicate and fragile equipment	321	origin	62, 183
trawl		principles	61, 182
fishing gear noise	59	vessel ground	
trawl information		cable	139
datagram formats	284	vessel noise	
trawl system		making a noise/speed curve	273
setting up the interface	239	VHW	
trays		datagram format	288, 290
cable requirements	167	visual inspection	
Trimble PTNL G GK		display	190
datagram format	283	transportation boxes	323
troubleshooting		units	323
time zone settings	222	visual inspection of the computer	192
TSS1		visual inspection of the EC150-3C Power	
datagram format	286	Supply Unit	197
turbulence		visual inspection of the Power Supply Unit	197
protruding objects	49	visual inspection of the Processor Unit	192
turn		visual inspection of the transceiver	193
off	276	visual inspection of the Transceiver Unit	193
on	202	visual inspection of the WBT Cabinet	195
		VLW	
<b>U</b>		datagram format	282
uninterruptible power supply		VTG	
installation requirements	37	datagram format	283, 288, 290
minimum requirements	35		
optional item	35	<b>W</b>	
recommended item	35	water level	
scope of supply	35	datagram formats	289
units		WBT	
selecting measurement units	225	cable plan	90–92
unpacking		compass safe distance	301
a hydrophone	329	connectors	104
a mechanical unit	327	description	21
a sonar head	329	environmental requirements	299
a transducer	329	installation	65, 67
an electronic or electromechanical unit	328		
instructions	325		

- introduction ..... 21
  - outline dimensions ..... 296, 308
  - overview ..... 21
  - power requirements ..... 293
  - power supply installation ..... 69
  - purpose ..... 21
  - synchronisation using Auxiliary
    - port ..... 134, 252
    - weight ..... 296
  - WBT Auxiliary socket
    - synchronization ..... 129
  - WBT Cabinet
    - compass safe distance ..... 302
    - environmental requirements ..... 299
    - mounting ..... 78
    - mounting the drawers ..... 81
    - outline dimensions ..... 297, 314
    - power requirements ..... 294
    - visual inspection ..... 195
    - weight ..... 297
  - WBT Mini
    - introduction ..... 22
    - overview ..... 22
    - purpose ..... 22
  - WBT Tube
    - introduction ..... 22
    - overview ..... 22
    - purpose ..... 22
  - website
    - download documents ..... 12
  - weight
    - computer ..... 295
    - display ..... 295
    - Ethernet switch ..... 296
    - Processor Unit ..... 295
    - technical specifications ..... 295
    - transceiver ..... 296
    - WBT Cabinet ..... 297
    - Wide Band Transceiver (WBT) ..... 296
  - when not in use
    - important reminder ..... 14
  - Wide Band Transceiver
    - synchronisation using Auxiliary
      - port ..... 134, 252
  - Wide Band Transceiver (WBT)
    - cable plan ..... 90–92
    - compass safe distance ..... 301
    - connectors ..... 104
    - description ..... 21
    - environmental requirements ..... 299
    - installation ..... 65, 67
    - introduction ..... 21
    - outline dimensions ..... 296, 308
    - overview ..... 21
    - power requirements ..... 293
    - power supply installation ..... 69
    - purpose ..... 21
    - weight ..... 296
  - Wide Band Transceiver (WBT) Auxiliary socket
    - synchronization ..... 129
  - wiring
    - installation requirements ..... 38
    - list of system interconnection cables ..... 94
    - prerequisites ..... 97
    - transducer connector ..... 318
  - wiring diagram
    - bridge ..... 89
    - computer ..... 89
    - topside ..... 89, 93
    - transceiver ..... 90–92
    - Wide Band Transceiver (WBT) ..... 90–92
  - worker skills
    - requirements for installation ..... 47
  - www.simrad.com
    - document downloads ..... 12
- X**
- XYZ
    - file format ..... 289–290
- Z**
- ZDA
    - datagram format ..... 283
  - ZMQ
    - datagram format ..... 289

©2020 Kongsberg Maritime

ISBN 978-82-8066-182-1





Installation Manual  
Simrad EK80